

Price list & Technical guide

Kitchen & Bedroom cabinets.



(ALL PRICES EXCLUDE VAT)

CONTENTS

Kitchen Door Ranges & Matching Accessories:-

- Piatto Plus pages 2 to 4
- Piatto Sense pages 5 & 6
- Vivo Gloss pages 7 & 8
- Vivo Matte Pages 9 & 10
- Cartmel Shaker pages 11 & 12
- Belsay Shaker pages 13 & 14
- Legno J Handle pages 15 & 16
- Lucente Gloss J Profile pages 17 & 18
- Lucente Matte J Profile pages 19 & 20
- Cambridge Shaker pages 21 & 22
- Windsor Beaded pages 23 & 24
- Cambridge & Windsor PTO pages 25 & 26
- Mornington Shaker pages 27 & 28
- Mornington Beaded pages 29 & 30
- Mornington PTO pages 31 & 32
- Porter Gloss pages 33 & 34
- Porter Matte pages 35 & 36
- Remo Gloss pages 37 & 38
- Remo Gloss pages 39 & 40
- Fitzroy Shaker pages 41 & 42
- Fitzroy Shaker PTO pages 43 & 44
- Ashbury Shaker Foundation pages 45 & 46
- Ashbury Shaker PTO pages 47 & 48
- Airo Gloss J Profile pages 49 & 50
- Airo PTO J Profile pages 51 & 52

Bedroom Door Ranges & Matching Accessories:-

- Piatto Plus pages 107 TO 109
- Piatto Sense pages 110 & 111
- Sliding Wardrobe Doors page 112

Kitchen Cabinets:-

- Cabinet Specification & Colours pages 53 & 54
- Cabinet Pricing & Technical Guide pages 55 & 56
- Melamine Matching Panels page 78
- Kitchen Cabinet Door Configurations pages 79 & 80

Integro Kitchen Cabinets:-

- Handle Rail System & accessories page 81
- Cabinet Pricing & Technical Guide pages 83 to 102
- Integro Cabinet Door Configurations pages 82

Bedroom Cabinets:-

- Wardrobe Pricing & Technical Guide pages 113 to 115
- Bedside Unit Pricing & Technical Guide pages 115 to 116
- Drawer Unit Pricing & Technical Guide pages 116 to 117

Storage Solutions & Wirework:-

- Base Pull Out Wirework page 103
- Corner Base Wirework page 104
- Larder Pull Outs & Pantry Wirework pages 105 & 106
- Pull Out Wire Baskets page 106
- Internal Drawer Boxes page 106

Cabinet Components & Drawer Systems:-

- Cabinet Hinges, Components & Screws pages 118 & 119
- Drawer Systems & Internal Fronts page 119
- Drawer Box Storage Inserts page 120

PRICING & DISCOUNTS

Below are the discounts to apply to each category, please note these discounts are based on ordering a full kitchen of 5 or more cabinets. VAT is to be added after any discount is applied.

Kitchen Cabinets	65.00	%	Wirework	20.00	%
Integro Cabinets	65.00	%	Sinks	20.00	%
Bedroom Cabinets	65.00	%	Taps	20.00	%
Cabinet Doors	0	%	Appliances	20.00	%
Matching Accessories	0	%	Worktops	20.00	%
Components	0	%	Lighting	20.00	%
Melamine Panels	50.00	%	Handles	20.00	%
Sliding Doors	25.00	%	Accessories	20.00	%

PIATTO PLUS (2 WEEK LEAD TIME)



This range is available in **INTEGRO** cabinets

Piatto is a slab style door manufactured using high grade melamine faced chipboard, edged using a durable ABS colour matched edging. All our Piatto doors are edged using a PUR gluing system, making this range the most hardwearing and moisture resistant range we offer. Piatto is available in a wide range of different textures, colours and finishes, and is available in made to measure sizes.

PAINTED WOOD EFFECT



**INDIGO BLUE
WOOD EFFECT**



**GRAPHITE
GREY**



**STONE GREY
WOOD EFFECT**

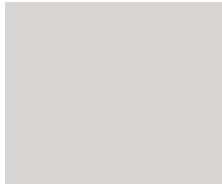

**LIGHT GREY
WOOD EFFECT**



**FJORD GREEN
WOOD EFFECT**

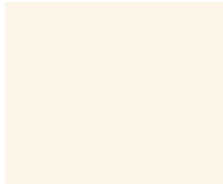

**ALABASTER
WOOD EFFECT**

PIATTO WOODGRAINS



PASADINA
PINE



WHITE HALIFAX
OAK



PEWTER HALIFAX
OAK



WHITEWOOD



KAISENBERG
OAK



LINCOLN
WALNUT



ANTHRACITE
FINELINE
METALIC



TRUFFLE BROWN
BRANSON
ROBINIA



SAND GREY
GLAZED HALIFAX
OAK



NATURAL
HALIFAX
OAK



CASCINA
PINE



VINTAGE
SANTA FE OAK



GREY
SANTA FE OAK

PIATTO INDUSTRIAL



ANTHRACITE LINEN



GREY TEXTILE

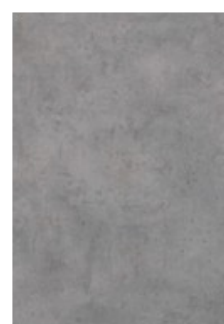

CHICAGO CONCRETE

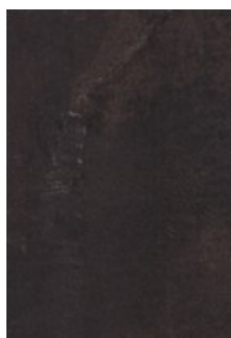

BLACK GOLD METAL SLATE

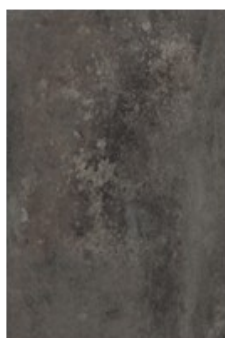

ANTHRACITE METAL ROCK



SILVER GREY METAL SLATE

SIZE	PRICE £	SIZE	PRICE £	SIZE	PRICE £
110X595 BLANK	£12.26	283X995 DOOR	£19.70	715X395 DOOR	£19.74
120X495 DRAWER	£12.04	325X495 DOOR	£15.54	715X445 DOOR	£21.92
120X595 DRAWER	£12.46	325X595 DOOR	£16.66	715X495 DOOR	£24.40
120X695 DRAWER	£12.88	325X795 DOOR	£18.90	715X545 DOOR	£26.84
120X795 DRAWER	£13.28	325X895 DOOR	£20.04	715X595 DOOR	£29.32
120X895 DRAWER	£13.70	325X995 DOOR	£22.28	895X295 DOOR	£19.10
120X995 DRAWER	£14.12	355X295 DOOR	£15.82	895X395 DOOR	£24.28
140X295 DRAWER	£11.42	355X495 DOOR	£16.06	895X445 DOOR	£27.44
140X395 DRAWER	£11.90	355X595 DOOR	£17.28	895X495 DOOR	£30.52
140X445 DRAWER	£12.14	355X795 DOOR	£19.72	895X595 DOOR	£36.72
140X495 DRAWER	£12.38	355X895 DOOR	£21.88	980X595 DOOR	£40.20
140X595 DRAWER	£12.88	355X995 DOOR	£24.36	1245X295 DOOR	£25.32
140X795 DRAWER	£13.84	450X595 DOOR	£19.22	1245X395 DOOR	£33.88
140X895 DRAWER	£14.32	490X595 DOOR	£20.08	1245X445 DOOR	£38.20
140X995 DRAWER	£14.80	570X295 DOOR	£15.80	1245X595 DOOR	£42.48
160X495 DRAWER	£12.72	570X395 DOOR	£17.76	1795X345 DOOR	£42.68
160X595 DRAWER	£13.28	570X445 DOOR	£18.74	1795X395 DOOR	£48.88
160X795 DRAWER	£14.38	570X495 DOOR	£19.72	1795X445 DOOR	£55.04
160X895 DRAWER	£14.94	570X595 DOOR	£23.36	1795X495 DOOR	£61.24
160X995 DRAWER	£15.48	645X595 DOOR	£26.44	1795X595 DOOR	£73.60
175X395 DRAWER	£12.38	685X145 DOOR	£16.90	1965X295 DOOR	£39.96
175X495 DRAWER	£12.98	685X295 DOOR	£16.96	1965X395 DOOR	£53.48
175X595 DRAWER	£13.58	685X345 DOOR	£18.14	1965X495 DOOR	£67.04
245X495 DRAWER	£14.18	685X395 DOOR	£19.32	1965X595 DOOR	£80.56
245X595 DRAWER	£15.02	685X445 DOOR	£21.00	2145X295 DOOR	£44.00
245X695 DRAWER	£15.86	685X495 DOOR	£23.36	2145X395 DOOR	£52.00
245X795 DRAWER	£16.72	685X545 DOOR	£25.72	2145X495 DOOR	£76.00
245X895 DRAWER	£17.56	685X595 DOOR	£28.08	2145X595 DOOR	£84.00
245X995 DRAWER	£18.40	715X145 DOOR	£13.58	2295X345 DOOR	£54.80
283X495 DOOR	£14.82	715X255 DOOR	£16.28	2295X395 DOOR	£62.48
283X595 DOOR	£15.80	715X295 DOOR	£17.26	2295X445 DOOR	£70.40
283X795 DOOR	£17.76	715X313 DOOR	£17.72	2295X495 DOOR	£78.28
283X895 DOOR	£18.74	715X345 DOOR	£18.50	2295X545 DOOR	£86.20
MATCHING ACCESSORIES (MELAMINE PANELS)				2295X595 DOOR	£94.12

CODE	DESCRIPTION	PRICE £	CODE	DESCRIPTION	PRICE £
WG2/CORNICE	2700X80MM CORNICE 2	£49.72	WG2/LEPAN	2400X650MM LARDER END PANEL 7	£124.28
WG2/PLINTH	2650X150MM KITCHEN PLINTH 1	£49.72	WG2/LEPAN2	2400X700MM LARDER END PANEL 8	£124.48
WG2/BPLINTH	2650X100MM BEDROOM PLINTH 2	£49.72	WG2/FLY1	1200X300MM FLYSHELF PANEL 9	£48.44
WG2/WPAN	720X350MM WALL END PANEL 4	£40.08	WG2/FLY2	320X2400MM FLYSHELF PANEL 10	£72.84
WG2/WPAN2	760X350MM WALL END PANEL 5	£40.08	WG2/BBAR1	950X1200MM BREAKFAST BAR PANEL 11	£97.28
WG2/TWPAN	900X350MM TALL WALL END PANEL 3	£43.92	WG2/BBAR2	950X2400MM BREAKFAST BAR PANEL 12	£174.56
WG2/BPAN	950X650MM BASE END PANEL 13	£63.84	WG2/BBBS	950X610MM BREAKFAST BAR SIDE 6	£61.28

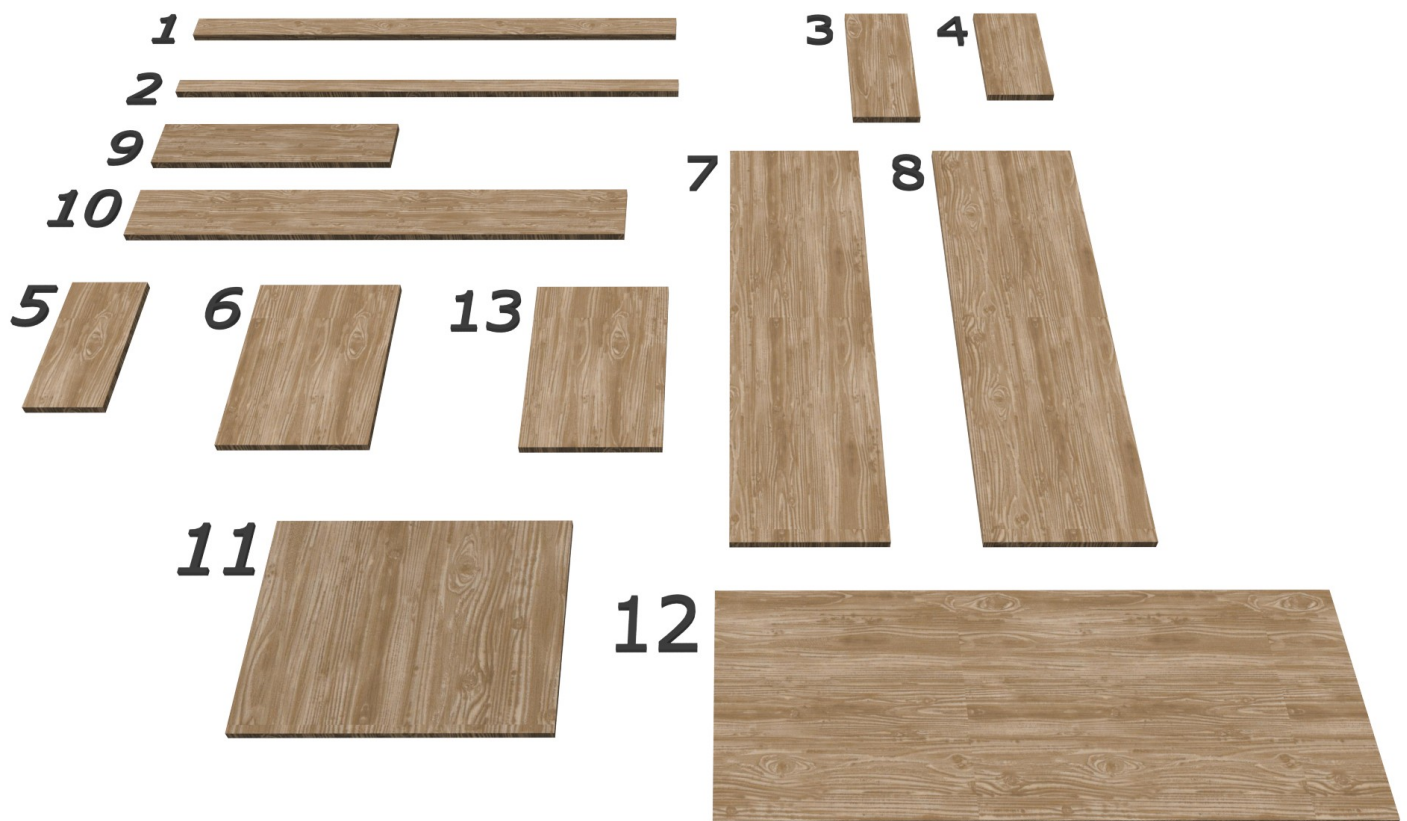

PIATTO SENSE (2 WEEK LEAD TIME)



This range is available in INTEGRO cabinets

Piatto Sense is a slab style door manufactured using high grade lacquered MDF edged using a durable ABS colour matched edging. All our Piatto doors are edged using a PUR gluing system, making this range the most hardwearing and moisture resistant range we offer.

PIATTO SENSE GLOSS COLOURS



GRAPHITE GREY



DUST GREY

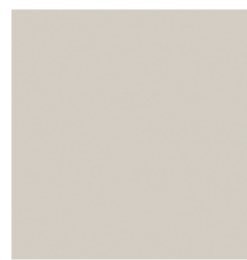

LIGHT GREY



CASHMERE GREY

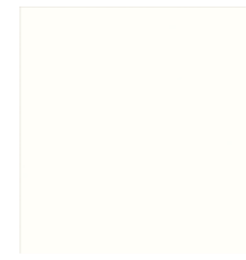

ALPINE WHITE

PIATTO SENSE MATTE COLOURS



GRAPHITE GREY



DUST GREY

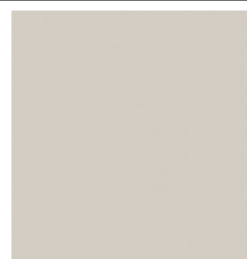

LIGHT GREY



INDIGO BLUE

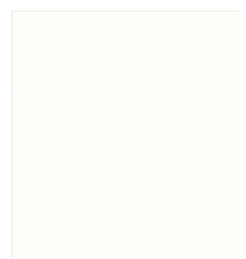

ALPINE WHITE

SIZE	PRICE £	SIZE	PRICE £	SIZE	PRICE £
110X595 BLANK	£13.28	283X995 DOOR	£24.08	715X395 DOOR	£24.12
120X495 DRAWER	£12.98	325X495 DOOR	£18.04	715X445 DOOR	£25.90
120X595 DRAWER	£13.58	325X595 DOOR	£19.66	715X495 DOOR	£27.70
120X695 DRAWER	£14.18	325X795 DOOR	£22.92	715X545 DOOR	£29.48
120X795 DRAWER	£14.78	325X895 DOOR	£24.54	715X595 DOOR	£31.92
120X895 DRAWER	£15.38	325X995 DOOR	£26.16	895X295 DOOR	£23.20
120X995 DRAWER	£15.98	355X295 DOOR	£15.24	895X395 DOOR	£27.68
140X295 DRAWER	£12.06	355X495 DOOR	£18.78	895X445 DOOR	£29.92
140X395 DRAWER	£12.76	355X595 DOOR	£20.56	895X495 DOOR	£33.24
140X445 DRAWER	£13.12	355X795 DOOR	£24.12	895X595 DOOR	£39.94
140X495 DRAWER	£13.46	355X895 DOOR	£25.88	980X595 DOOR	£43.74
140X595 DRAWER	£14.16	355X995 DOOR	£27.66	1245X295 DOOR	£28.36
140X795 DRAWER	£15.56	450X595 DOOR	£23.38	1245X395 DOOR	£36.88
140X895 DRAWER	£16.26	490X595 DOOR	£24.58	1245X445 DOOR	£41.56
140X995 DRAWER	£16.96	570X295 DOOR	£18.40	1245X595 DOOR	£55.56
160X495 DRAWER	£13.96	570X395 DOOR	£21.26	1795X345 DOOR	£46.44
160X595 DRAWER	£14.76	570X445 DOOR	£22.68	1795X395 DOOR	£53.20
160X795 DRAWER	£16.36	570X495 DOOR	£24.10	1795X445 DOOR	£59.92
160X895 DRAWER	£17.16	570X595 DOOR	£27.16	1795X495 DOOR	£66.64
160X995 DRAWER	£17.96	645X595 DOOR	£29.18	1795X595 DOOR	£80.10
175X395 DRAWER	£13.46	685X145 DOOR	£14.96	1965X295 DOOR	£43.48
175X495 DRAWER	£14.34	685X295 DOOR	£20.10	1965X395 DOOR	£58.20
175X595 DRAWER	£15.20	685X345 DOOR	£21.82	1965X495 DOOR	£72.90
245X495 DRAWER	£16.06	685X395 DOOR	£23.52	1965X595 DOOR	£87.70
245X595 DRAWER	£17.28	685X445 DOOR	£25.24	2145X295 DOOR	£47.56
245X695 DRAWER	£18.52	685X495 DOOR	£26.96	2145X395 DOOR	£63.54
245X795 DRAWER	£19.74	685X545 DOOR	£28.66	2145X495 DOOR	£79.62
245X895 DRAWER	£20.96	685X595 DOOR	£30.58	2145X595 DOOR	£95.74
245X995 DRAWER	£22.18	715X145 DOOR	£15.18	2295X345 DOOR	£59.38
283X495 DOOR	£17.00	715X255 DOOR	£19.12	2295X395 DOOR	£67.98
283X595 DOOR	£18.42	715X295 DOOR	£20.54	2295X445 DOOR	£76.60
283X795 DOOR	£21.24	715X313 DOOR	£21.18	2295X495 DOOR	£85.20
283X895 DOOR	£22.66	715X345 DOOR	£22.34	2295X545 DOOR	£93.82
MATCHING ACCESSORIES (MELAMINE PANELS)				2295X595 DOOR	£102.42

STOCK CODE	DESCRIPTION	PRICE	CODE	DESCRIPTION	PRICE
PS/CORNICE	2100X38MM CORNICE 2	£60.00	PS/LEPAN	2400X650MM LARDER END PANEL 7	£117.00
PS/PLINTH	2650X150MM KITCHEN PLINTH 1	£29.88	PS/LEPAN2	2400X700MM LARDER END PANEL 8	£126.00
PS/BPLINTH	2650X100MM BEDROOM PLINTH 2	£23.26	PS/FLY1	1200X300MM FLYSHELF PANEL 9	£28.00
PS/WPAN	720X350MM WALL END PANEL 4	£22.60	PS/FLY2	320X2400MM FLYSHELF PANEL 10	£57.60
PS/WPAN2	760X350MM WALL END PANEL 5	£23.30	PS/BBAR1	950X1200MM BREAKFAST BAR PANEL 11	£85.50
PS/TWPAN	900X350MM TALL WALL END PANEL 3	£25.76	PS/BBAR2	950X2400MM BREAKFAST BAR PANEL 12	£171.00
PS/BPAN	950X650MM BASE END PANEL 13	£46.32	PS/BBS	950X610MM BREAKFAST BAR SIDE 6	£43.48

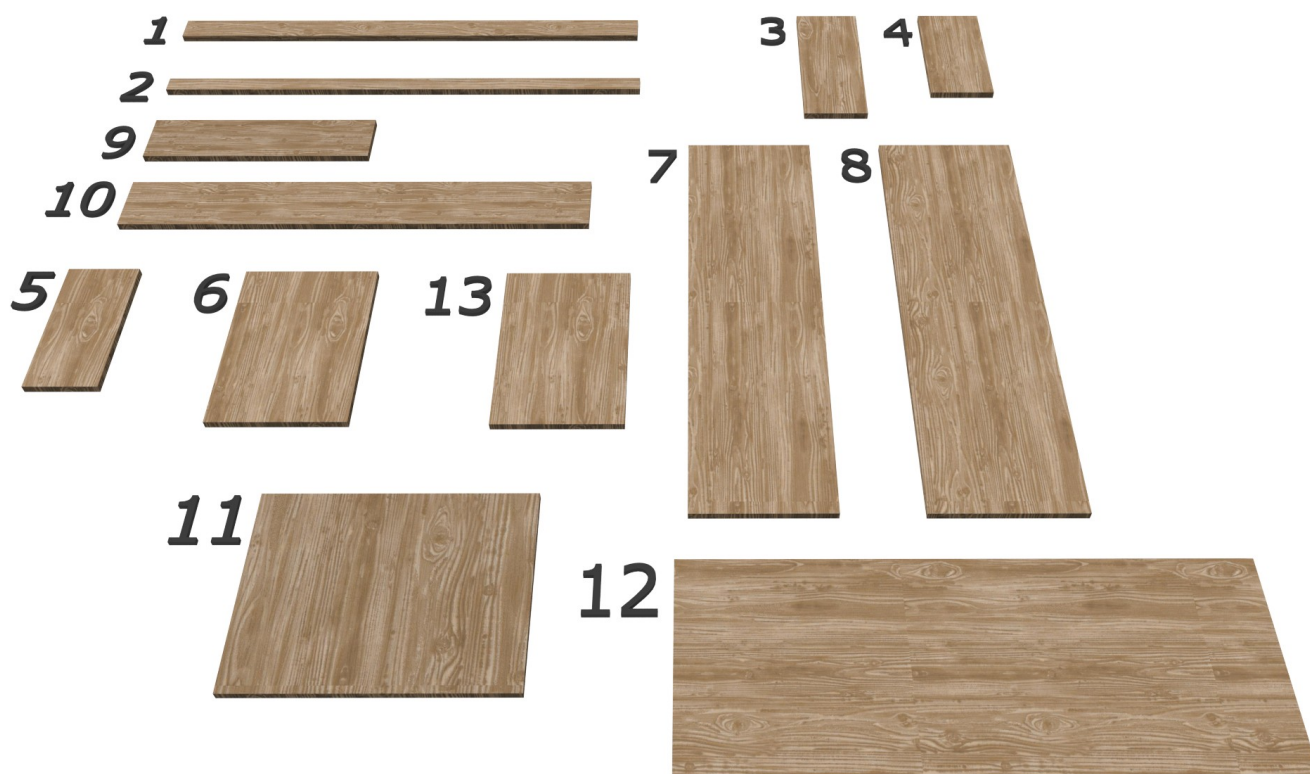

VIVO GLOSS (2 WEEK LEAD TIME)



Vivo Gloss is a slab style door, manufactured using MDF, which is then painted to the colours illustrated below. Each door is finished with a high gloss lacquer.



**This range is available
in INTEGRO cabinets**



ANTHRACITE



DUST GREY



LIGHT GREY



CASHMERE



STONE



IVORY

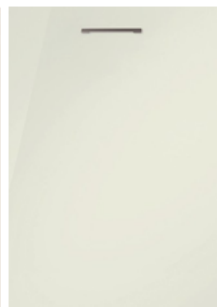

PORCELAIN



WHITE

VIVO GLOSS

SIZE	PRICE	SIZE	PRICE	SIZE	PRICE	SIZE	PRICE
110X595 BLANK	£12.68	283X895 DOOR	£23.16	685X147 DOOR	£13.82	895X295 DOOR	£25.20
140X295 DRAWER	£9.22	283X995 DOOR	£23.90	685X295 DOOR	£20.06	895X395 DOOR	£31.02
140X395 DRAWER	£10.60	325X495 DOOR	£18.60	685X315 DOOR	£22.24	895X445 DOOR	£32.58
140X445 DRAWER	£11.16	325X595 DOOR	£20.72	685X345 DOOR	£21.56	895X495 DOOR	£36.10
140X495 DRAWER	£11.60	325X795 DOOR	£24.80	685X395 DOOR	£21.70	895X595 DOOR	£41.14
140X595 DRAWER	£14.04	325X895 DOOR	£26.94	685X445 DOOR	£22.10	980X595 DOOR	£45.30
140X795 DRAWER	£14.30	325X995 DOOR	£29.64	685X495 DOOR	£22.44	1245X255 DOOR	£36.50
140X895 DRAWER	£15.72	355X495 DOOR	£18.52	685X545 DOOR	£27.74	1245X295 DOOR	£37.06
140X995 DRAWER	£16.84	355X595 DOOR	£20.84	685X595 DOOR	£28.56	1245X395 DOOR	£44.94
160X495 DRAWER	£13.04	355X795 DOOR	£25.06	715X145 DOOR	£14.78	1245X445 DOOR	£49.32
160X595 DRAWER	£14.62	355X895 DOOR	£27.24	715X255 DOOR	£22.24	1245X495 DOOR	£56.16
160X795 DRAWER	£16.50	355X995 DOOR	£29.96	715X277 DOOR	£22.48	1245X595 DOOR	£65.14
160X895 DRAWER	£18.14	450X595 DOOR	£23.64	715X295 DOOR	£21.12	1965X295 DOOR	£81.04
160X995 DRAWER	£18.60	490X595 DOOR	£23.68	715X313 DOOR	£22.48	1965X395 DOOR	£97.62
175X395 DRAWER	£10.98	570X295 DOOR	£18.04	715X345 DOOR	£22.68	1965X495 DOOR	£118.06
175X495 DRAWER	£14.28	570X395 DOOR	£21.38	715X395 DOOR	£22.86	1965X595 DOOR	£136.20
175X595 DRAWER	£14.60	570X445 DOOR	£23.54	715X445 DOOR	£23.26	715 CURVE	£174.04
283X495 DOOR	£16.12	570X495 DOOR	£24.24	715X495 DOOR	£23.62	895 CURVE	£313.98
283X595 DOOR	£17.16	570X595 DOOR	£27.50	715X545 DOOR	£29.20	1245 CURVE	£393.14
283X795 DOOR	£20.84	645X595 DOOR	£29.34	715X595 DOOR	£30.08	715X495 GLAZED	£69.98

MATCHING ACCESSORIES

CODE	DESCRIPTION	PRICE £	CODE	DESCRIPTION	PRICE
VIV/MCOR	UNIVERSAL 3M CORNICE	£29.48	VIV/WPAN	792X350MM END PANEL	£26.91
VIV/CURCOR	UNIVERSAL EXTERNAL CURVED CORNICE	£48.84	VIV/BPAN	900X650MM END PANEL	£44.80
VIV/PLIN	3050X150MM PLINTH	£49.42	VIV/LAR	2400X650MM END PANEL	£133.31
VIV/CURPLIN	EXTERNAL CURVED PLINTH	£86.34	VIV/BBAR	2400X900MM END PANEL	£202.38
VIV/CBLOCK	CORNER BLOCK	£45.23	VIV/2.4CP	2400X46MM EXTERNAL C/POST	£175.42
VIV/CUREND	CURVED END POST	£116.89	VIV/900CP	900X46MM EXTERNAL C/POST	£79.05
VIV/FLY	1245X395 FLYSHELF	£44.93	VIV/325CP	324X46MM EXTERNAL C/POST	£36.67
VIV/1.2PAN	685X1200MM END PANEL	£65.09	VIV/INTCP	720X70MM INTERNAL C/POST	£37.29



Plinth*

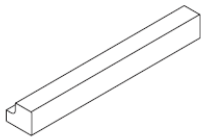

Straight Square End Cornice/Pelmet



Straight Cornice/Filler Piece

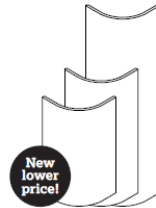

Curved Doors
715, 895 & 1245mm heights**

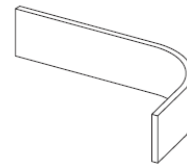

Curved Plinth

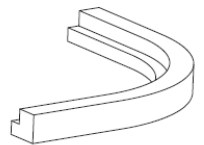

Curved Square End Cornice/Pelmet



External Corner Post



Internal Corner Post



Curved End Post



Curved End Post
(for Curved End Post)



End Panel

Please note:

Unless otherwise stated, all our curved doors and accessories are external curves.

* Please note, if you need a filler piece we recommend using Straight Cornice/Filler.

** 1245mm curved doors not available in Dust Grey.

VIVO MATTE (2 WEEK LEAD TIME)



Vivo Matte is a slab style door, manufactured using MDF, which is then painted to a soft sheen finish.



**This range is available
in INTEGRO cabinets**



ANTHRACITE

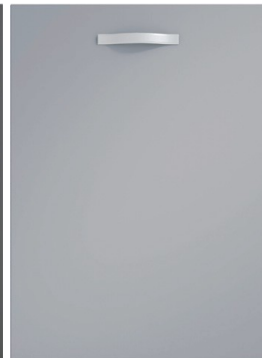

DUST GREY

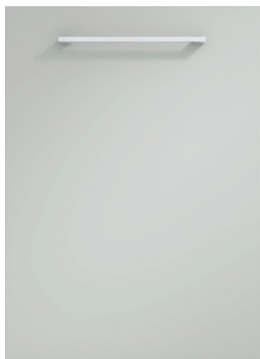

LIGHT GREY

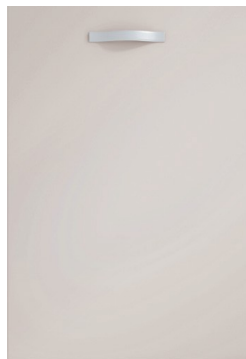

CASHMERE



IVORY

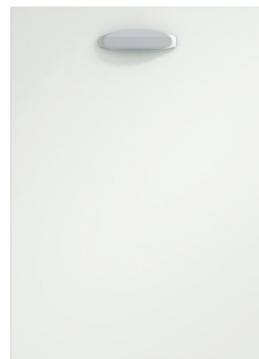

WHITE

VIVO MATTE							
SIZE	PRICE	SIZE	PRICE	SIZE	PRICE	SIZE	PRICE
110X595 BLANK	£12.00	283X895 DOOR	£21.94	685X147 DOOR	£13.08	895X295 DOOR	£23.86
140X295 DRAWER	£8.74	283X995 DOOR	£22.64	685X295 DOOR	£19.00	895X395 DOOR	£29.38
140X395 DRAWER	£10.06	325X495 DOOR	£17.62	685X315 DOOR	£21.06	895X445 DOOR	£30.86
140X445 DRAWER	£10.58	325X595 DOOR	£19.64	685X345 DOOR	£20.42	895X495 DOOR	£34.20
140X495 DRAWER	£10.98	325X795 DOOR	£23.48	685X395 DOOR	£20.56	895X595 DOOR	£38.98
140X595 DRAWER	£13.30	325X895 DOOR	£25.52	685X445 DOOR	£20.94	980X595 DOOR	£42.92
140X795 DRAWER	£13.54	325X995 DOOR	£28.08	685X495 DOOR	£21.26	1245X255 DOOR	£34.58
140X895 DRAWER	£14.88	355X495 DOOR	£17.54	685X545 DOOR	£26.28	1245X295 DOOR	£35.10
140X995 DRAWER	£15.94	355X595 DOOR	£19.74	685X595 DOOR	£27.06	1245X395 DOOR	£42.56
160X495 DRAWER	£12.36	355X795 DOOR	£23.74	715X145 DOOR	£14.00	1245X445 DOOR	£46.72
160X595 DRAWER	£13.84	355X895 DOOR	£25.80	715X255 DOOR	£21.08	1245X495 DOOR	£53.20
160X795 DRAWER	£16.50	355X995 DOOR	£23.38	715X277 DOOR	£21.30	1245X595 DOOR	£61.72
160X895 DRAWER	£17.18	450X595 DOOR	£22.40	715X295 DOOR	£20.00	1965X295 DOOR	£76.78
160X995 DRAWER	£17.62	490X595 DOOR	£22.42	715X313 DOOR	£21.30	1965X395 DOOR	£92.48
175X395 DRAWER	£10.42	570X295 DOOR	£17.10	715X345 DOOR	£21.50	1965X495 DOOR	£111.84
175X495 DRAWER	£13.52	570X395 DOOR	£20.26	715X395 DOOR	£21.66	1965X595 DOOR	£129.04
175X595 DRAWER	£13.84	570X445 DOOR	£22.30	715X445 DOOR	£22.04	715 CURVE	£164.88
283X495 DOOR	£15.28	570X495 DOOR	£22.96	715X495 DOOR	£22.38	895 CURVE	£297.46
283X595 DOOR	£16.26	570X595 DOOR	£26.04	715X545 DOOR	£27.66	1245 CURVE	£372.44
283X795 DOOR	£19.74	645X595 DOOR	£27.80	715X595 DOOR	£28.50	715X495 GLAZED	£67.40

MATCHING ACCESSORIES

STOCK CODE	DESCRIPTION	PRICE	CODE	DESCRIPTION	PRICE
VIVC/COR	UNIVERSAL 3M CORNICE	£27.93	VIVC/WPAN	792X350MM END PANEL	£25.50
VIVC/CURCOR	UNIVERSAL EXTERNAL CURVED CORNICE	£45.96	VIVC/PAN	900X650MM END PANEL	£42.44
VIVC/PLIN	3050X150MM PLINTH	£46.82	VIVC/LAR	2400X650MM END PANEL	£126.30
VIVC/CURPLIN	EXTERNAL CURVED PLINTH	£81.80	VIVC/BBAR	2400X900MM END PANEL	£191.72
VIVC/CBLOCK	CORNER BLOCK	£42.85	VIVC/2.4CP	2400X46MM EXTERNAL C/POST	£166.20
VIVC/CUREND	CURVED END POST	£110.74	VIVC/900CP	900X46MM EXTERNAL C/POST	£74.89
VIVC/FLY	1245X395 FLYSHELF	£42.57	VIVC/325CP	324X46MM EXTERNAL C/POST	£34.74
VIVC/1.2PAN	685X1200MM END PANEL	£61.66	VIVC/INTCP	720X70MM INTERNAL C/POST	£35.32

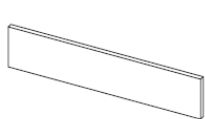

Plinth*

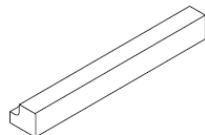

Straight Square End Cornice/Pelmet



Straight Cornice/Filler Piece

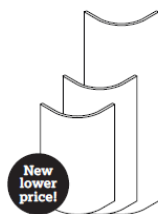

Curved Doors
715, 895 & 1245mm heights**

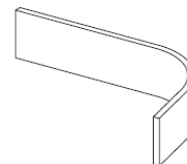

Curved Plinth

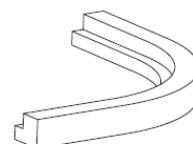

Curved Square End Cornice/Pelmet



External Corner Post



Internal Corner Post



Curved End Post



Curved End Post
(for Curved End Post)



End Panel

Please note:

Unless otherwise stated, all our curved doors and accessories are external curves.

* Please note, if you need a filler piece we recommend using Straight Cornice/Filler.

** 1245mm curved doors not available in Dust Grey.

CARTMEL (2 WEEK LEAD TIME)



Cartmel is a high quality 5 piece sectional shaker door, manufactured using MDF. Each section is individually laminated with a PVC vinyl before the sections are assembled. This gives the look of a solid timber door at a much lower price point.



DUST GREY



LIGHT GREY



SMOOTH OAK

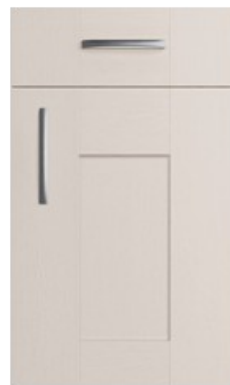

CASHMERE



DAKAR



MUSSEL



SAGE GREEN

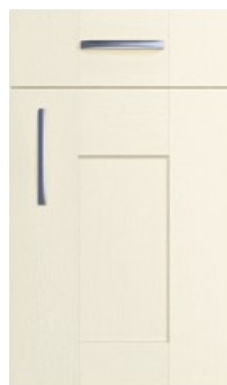

IVORY



WHITE

CARTMEL

SIZE	PRICE	SIZE	PRICE	SIZE	PRICE	SIZE	PRICE
110X595 BLANK	£11.86	283X895 DOOR	£22.46	715X145 DOOR	£20.44	895X595 DOOR	£36.30
140X295 DRAWER	£10.20	283X995 DOOR	£24.58	715X255 DOOR	£20.56	980X595 DOOR	£39.98
140X395 DRAWER	£11.00	355X495 DOOR	£18.76	715X273 DOOR	£21.28	1245X255 DOOR	£30.92
140X445 DRAWER	£11.30	355X595 DOOR	£20.40	715X295 DOOR	£21.48	1245X295 DOOR	£30.78
140X495 DRAWER	£11.76	355X795 DOOR	£23.54	715X313 DOOR	£22.00	1245X395 DOOR	£36.94
140X595 DRAWER	£12.70	355X895 DOOR	£25.14	715X345 DOOR	£22.76	1245X495 DOOR	£41.84
140X795 DRAWER	£14.18	355X995 DOOR	£26.74	715X395 DOOR	£23.80	1245X595 DOOR	£46.66
140X895 DRAWER	£15.16	450X595 DOOR	£22.66	715X445 DOOR	£25.36	715 CURVE	£157.36
140X995 DRAWER	£16.06	490X595 DOOR	£23.14	715X495 DOOR	£25.54	895 CURVE	£231.58
175X395 DRAWER	£11.50	570X295 DOOR	£18.66	715X545 DOOR	£27.50	1245 CURVE	£302.72
175X495 DRAWER	£12.50	570X395 DOOR	£20.94	715X595 DOOR	£27.68	715X395 GLAZED	£58.84
175X595 DRAWER	£13.32	570X445 DOOR	£22.84	895X295 DOOR	£24.86	715X495 GLAZED	£61.64
283X495 DOOR	£17.04	570X495 DOOR	£23.66	895X395 DOOR	£29.24	715X595 GLAZED	£64.26
283X595 DOOR	£18.10	570X595 DOOR	£25.92	895X445 DOOR	£31.00	895X495 GLAZED	£65.90
283X795 DOOR	£20.82	645X595 DOOR	£27.08	895X495 DOOR	£32.80	1060X495 GLAZED	£74.36

MATCHING ACCESSORIES

STOCK CODE	DESCRIPTION	PRICE	STOCK CODE	DESCRIPTION	PRICE
CARTIV/COR	3M TANGENT CORNICE	£33.24	CARTIV/WPAN	830X350MM END PANEL	£24.60
CARTIV/CURCOR	EXTERNAL TANGENT CURVED CORNICE	£145.36	CARTIV/BPAN	900X650MM END PANEL	£48.70
CARTIV/MCOR	UNIVERSAL CORNICE/PELMET	£26.90	CARTIV/LAR	2400X650MM END PANEL	£107.90
CARTIV/CURCOR	EXTERNAL UNIVERSAL CURVED CORNICE	£37.36	CARTIV/TGLAR	2400X650MM T&G END PANEL	£123.75
CARTIV/PEL	3M TANGENT PELMET	£21.32	CARTIV/900PAN	2400X900MM END PANEL	£143.02
CARTIV/PLIN	3050X150MM PLINTH	£49.96	CARTIV/PLATE	1200MM PLATE RACK	£92.17
CARTIV/CURPLIN	EXTERNAL CURVED PLINTH	£74.70	CARTIV/BOTTLE	1500MM BOTTLE RACK	£30.79
CARTIV/BLOK	CURVED CORNICE BLOCK	£93.80	CARTIV/MANTEL	COMPLETE MANTEL KIT	£406.54
CARTIV/CPIL	2400X100X50MM CURVED END PILLAR	£52.00	CARTIV/PIL	950X100 BARREL PILLASTER	£79.44
CARTIV/SPIIL	2400X100X50MM STRAIGHT END PILLAR	£52.00	CARTIV/COL	950X80MM FLOOR COLUMN	£105.88
CARTIV/POST	715X70MM CORNER POST	£20.87			

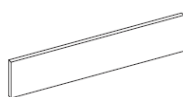

Plinth

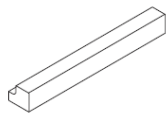

Straight Square End Cornice/Pelmet

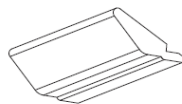

Tangent Cornice

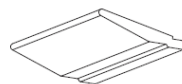

Tall Tangent Cornice*

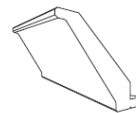

Contour Cornice*

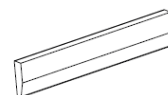

Tangent Pelmet



Curved Doors**
715, 895 & 1245mm heights

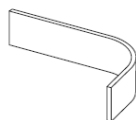

Curved Plinth

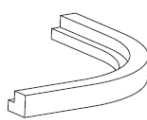

Curved Square End Cornice/Pelmet

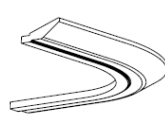

Curved Tangent Cornice



Corner Post (pair)



Straight End Pillar



Curved End Pillar



Curved Cornice Block for curved end pillar



Floor Column timber***



Barrel Pilaster timber***

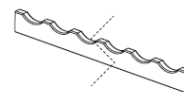

Bottle Rack timber***

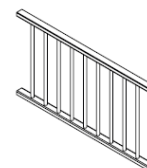
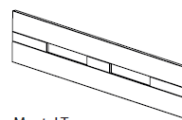
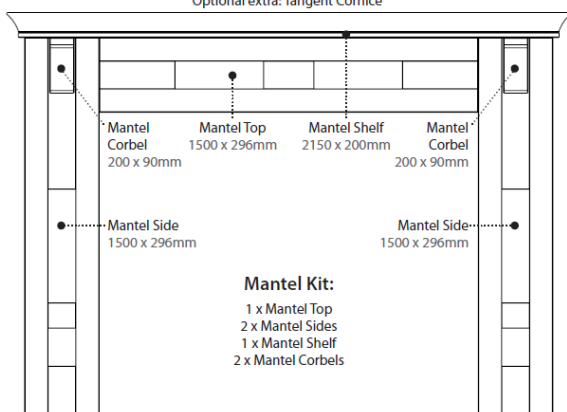

Plate Rack timber***

Optional extra: Tangent Cornice



Mantel Top



Mantel Side



End Panel



Mantel Shelf



Mantel Corbel timber***

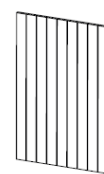

T&G End Panel

BELSAY (2 WEEK LEAD TIME)



Belsay is a high quality 5 piece sectional beaded shaker door, manufactured using MDF. Each section is individually laminated with a PVC vinyl before the sections are assembled. This gives the look of a solid timber door at a much lower price point.



GRAPHITE



DOVE GREY



CASHMERE



PORCELAIN

BELSAY							
SIZE	PRICE	SIZE	PRICE	SIZE	PRICE	SIZE	PRICE
110X595 BLANK	£9.24	283X895 DOOR	£26.22	570X445 DOOR	£24.36	895X395 DOOR	£29.64
140X295 DRAWER	£8.14	283X995 DOOR	£28.10	570X495 DOOR	£25.30	895X445 DOOR	£31.22
140X395 DRAWER	£8.92	355X495 DOOR	£20.64	570X595 DOOR	£28.04	895X495 DOOR	£33.54
140X445 DRAWER	£9.34	355X595 DOOR	£22.70	645X595 DOOR	£33.10	895X595 DOOR	£37.30
140X495 DRAWER	£9.52	355X795 DOOR	£26.66	715X145 DOOR	£11.10	980X595 DOOR	£40.20
140X595 DRAWER	£10.46	355X895 DOOR	£29.02	715X295 DOOR	£22.24	1245X295 DOOR	£32.06
140X795 DRAWER	£12.46	355X995 DOOR	£31.18	715X345 DOOR	£23.74	1245X395 DOOR	£37.90
140X895 DRAWER	£13.42	450X595 DOOR	£25.30	715X395 DOOR	£24.72	1245X495 DOOR	£42.42
140X995 DRAWER	£14.34	490X395 DOOR	£21.24	715X445 DOOR	£27.22	1245X595 DOOR	£48.82
283X495 DOOR	£18.40	490X595 DOOR	£26.38	715X495 DOOR	£28.46	1965X295 DOOR	£45.42
283X595 DOOR	£20.70	570X295 DOOR	£19.90	715X595 DOOR	£32.66	1965X595 DOOR	£65.68
283X795 DOOR	£24.40	570X395 DOOR	£22.46	895X295 DOOR	£25.24	715X495 GLAZED	£35.10

MATCHING ACCESSORIES					
CODE	DESCRIPTION	PRICE	CODE	DESCRIPTION	PRICE
BELS/COR	3M CORNICE	£41.56	BELS/WPAN	774X370MM END PANEL	£26.01
BELS/MCOR	UNIVERSAL 3M CORNICE/PELMET	£23.58	BELS/TWPAN	954X370MM END PANEL	£33.31
BELS/PLIN	3050X150MM PLINTH	£38.64	BELS/PAN	900X650MM END PANEL	£45.88
BELS/POST	715X70MM CORNER POST	£20.54	BELS/LAR	2400X650MM END PANEL	£117.44
BELS/FEND	2400X75X50MM FEATURE END POST	£63.42	BELS/BBAR	2400X900MM END PANEL	£190.26

DOORS

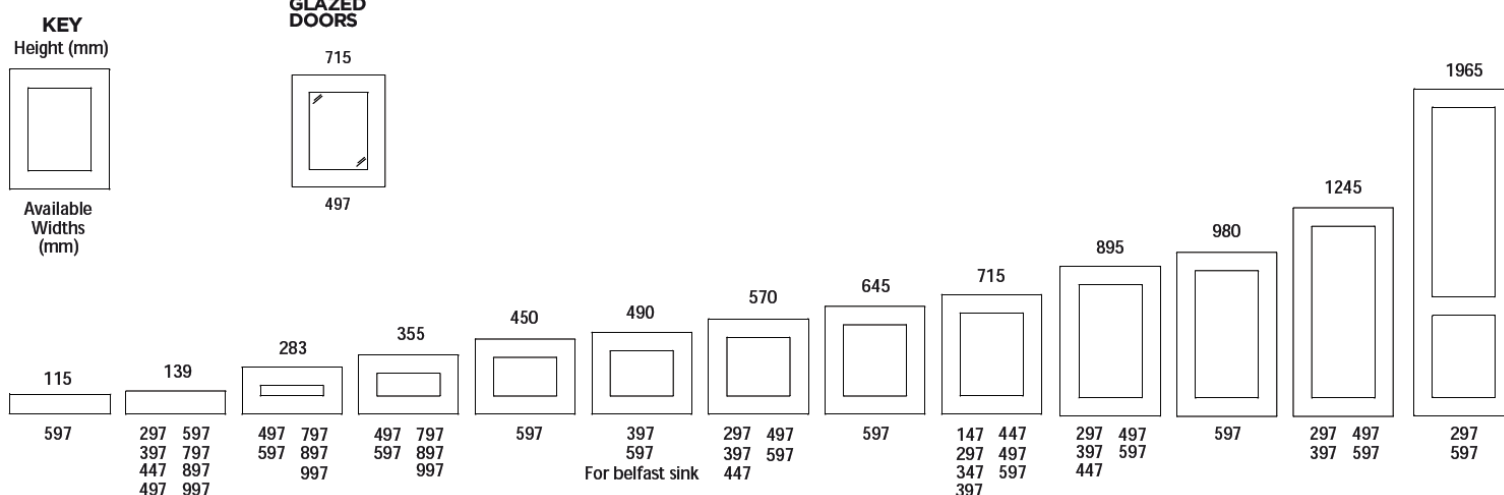

ACCESSORIES

CORNICE

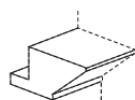

Classic cornice,
3050x102x90mm

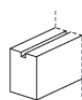

Modern cornice/light pelmet
3050x50x28mm

PLINTH

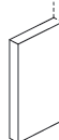

Plinth, 3050x150x16mm

FEATURE POSTS

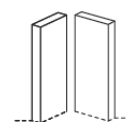

Corner post,
715x70x18mm

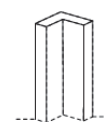

Tall feature end post
2400x75x50mm

END PANELS

↑ Indicates vertical grain direction

↔ Indicates horizontal grain direction

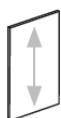

Base end panel,
900x650x18mm



Wall end panel
774x370x18mm



Tall wall end panel
954x370x18mm



Tall tower end panel
2400x650x18mm

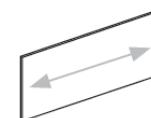

Breakfast bar end panel
900x2400x18mm

LEGNO (2 WEEK LEAD TIME)



Legno is a J profile door with integrated handle. This range is manufactured using MDF covered with a hard wearing textured laminate.

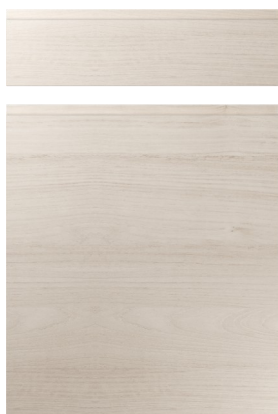

**BLEACHED
ASH**

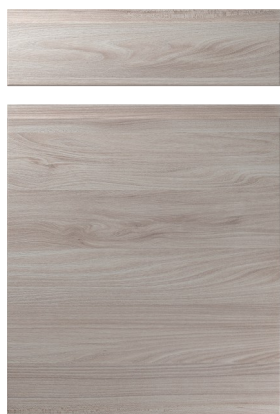

GREY ASH



**CORTEX
STEEL**

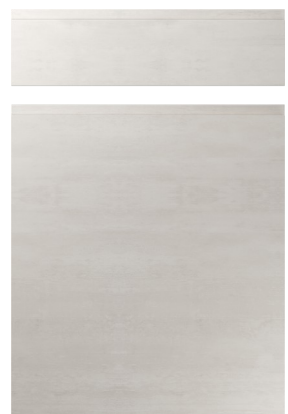

**CORTEX
CRYSTAL**



LEGNO

SIZE	PRICE	SIZE	PRICE	SIZE	PRICE	SIZE	PRICE
110X595 BLANK	£16.16	283X595 DOOR	£25.46	490X595 DOOR	£33.08	715X495 DOOR	£37.86
140X295 DRAWER	£16.06	283X795 DOOR	£29.24	570X295 DOOR	£27.18	715X595 DOOR	£41.34
140X395 DRAWER	£17.46	283X895 DOOR	£31.14	570X395 DOOR	£30.14	895X295 DOOR	£35.60
140X445 DRAWER	£18.14	283X995 DOOR	£33.04	570X445 DOOR	£31.60	895X395 DOOR	£39.72
140X495 DRAWER	£18.82	355X495 BLANK	£24.52	570X495 DOOR	£33.08	895X445 DOOR	£41.80
140X595 DRAWER	£20.20	355X495 DOOR	£25.94	570X595 DOOR	£36.02	895X495 DOOR	£43.84
140X795 DRAWER	£22.96	355X595 BLANK	£26.68	645X595 DOOR	£35.86	895X595 DOOR	£47.96
140X895 DRAWER	£24.32	355X595 DOOR	£28.10	715X145 DOOR	£25.80	980X595 DOOR	£52.48
140X995 DRAWER	£25.72	355X795 BLANK	£31.00	715X245 DOOR	£29.14	1060X595 DOOR	£55.42
175X395 DRAWER	£18.46	355X795 DOOR	£32.42	715X255 DOOR	£29.58	1245X295 DOOR	£46.74
175X495 DRAWER	£19.98	355X895 BLANK	£33.14	715X282 DOOR	£30.46	1245X395 DOOR	£52.12
175X595 DRAWER	£21.48	355X895 DOOR	£34.56	715X295 DOOR	£30.94	1245X445 DOOR	£54.82
283X395 DOOR	£21.66	355X995 BLANK	£35.32	715X345 DOOR	£32.70	1245X495 DOOR	£57.52
283X445 DOOR	£22.60	355X995 DOOR	£36.72	715X395 DOOR	£34.42	1245X595 DOOR	£62.90
283X495 DOOR	£23.56	450X595 DOOR	£31.80	715X445 DOOR	£36.14	715 CURVE	£246.22

MATCHING ACCESSORIES

CODE	DESCRIPTION	PRICE	CODE	DESCRIPTION	PRICE
LEGNO/COR	UNIVERSAL 2.8M CORNICE/PELMET	£85.00	LEGNO/WEPAN	720X370MM END PANEL	£31.62
LEGNO/CURCOR	UNIVERSAL EXTERNAL CURVED CORNICE	£66.78	LEGNO/TWPAN	810X370MM END PANEL	£35.06
LEGNO/PLIN	2800X150MM PLINTH	£59.72	LEGNO/BEPAN	900X650MM END PANEL	£46.92
LEGNO/CURPLIN	EXTERNAL CURVED PLINTH	£85.00	LEGNO/LAR	2400X650MM END PANEL	£103.90
LEGNO/EXTPOST	715X72X22MM EXTERNAL CORNER POST	£56.50	LEGNO/INTPOST	715X50X22MM INTERNAL C/POST	£55.08

LUCENTE GLOSS (2 WEEK LEAD TIME)



Lucente Gloss is a J profile door with integrated handle. This range is manufactured using MDF, which is then painted and lacquered to a high gloss.



**ANTHRACITE
GROUP B**



**DUST GREY
GROUP A**



**LIGHT GREY
GROUP A**

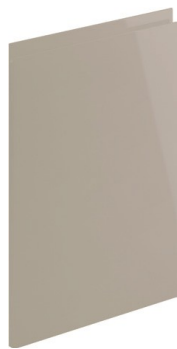

**PAVILION
GROUP A**

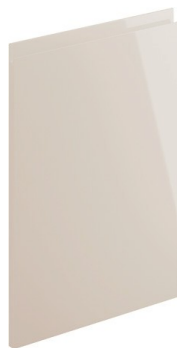

**STONE
GROUP A**



**CASHMERE
GROUP A**



**CREAM
GROUP A**



**PORCELAIN
GROUP A**



**WHITE
GROUP A**

LUCENTE GLOSS A & B

SIZE	PRICE A	PRICE B	SIZE	PRICE A	PRICE B	SIZE	PRICE A	PRICE B
110X595 BLANK	£11.14	£12.48	355X795 DOOR	£35.92	£40.22	715X545 DOOR	£50.56	£56.62
140X295 DRAWER	£8.78	£9.84	355X895 BLANK	£37.30	£41.78	715X595 DOOR	£46.58	£52.16
140X395 DRAWER	£10.38	£11.62	355X895 DOOR	£39.88	£44.66	895X295 DOOR	£33.50	£37.52
140X445 DRAWER	£11.20	£12.54	355X995 BLANK	£41.04	£45.96	895X395 DOOR	£42.38	£47.46
140X495 DRAWER	£12.02	£13.46	355X995 DOOR	£43.84	£49.10	895X445 DOOR	£46.80	£52.42
140X595 DRAWER	£13.64	£15.28	450X595 DOOR	£32.40	£36.28	895X495 DOOR	£50.44	£56.50
140X795 DRAWER	£16.90	£18.92	490X595 DOOR	£33.90	£37.96	895X595 DOOR	£58.22	£65.20
140X895 DRAWER	£18.50	£20.72	570X295 DOOR	£22.38	£25.06	980X595 DOOR	£64.92	£72.70
140X995 DRAWER	£20.14	£22.56	570X395 DOOR	£28.22	£31.60	1245X255 DOOR	£50.82	£56.92
175X395 DRAWER	£11.04	£12.36	570X445 DOOR	£31.18	£34.92	1245X295 DOOR	£44.14	£49.44
175X495 DRAWER	£13.82	£15.48	570X495 DOOR	£31.82	£35.64	1245X395 DOOR	£56.22	£62.96
175X595 DRAWER	£15.80	£17.70	570X595 DOOR	£36.88	£41.30	1245X445 DOOR	£63.32	£70.92
283X495 DOOR	£20.06	£22.46	645X595 DOOR	£41.82	£46.84	1245X495 DOOR	£68.26	£76.46
283X595 DOOR	£23.28	£26.08	715X145 DOOR	£16.06	£17.98	1245X595 DOOR	£80.32	£89.96
283X795 DOOR	£29.76	£33.34	715X255 DOOR	£24.62	£27.58	1965X595 DOOR	£138.30	£154.90
283X895 DOOR	£32.98	£36.94	715X273 DOOR	£26.20	£29.34	715 CURVE	£194.04	£217.32
283X995 DOOR	£36.22	£40.56	715X295 DOOR	£26.80	£30.02	895 CURVE	£272.26	£304.92
355X495 BLANK	£22.86	£25.60	715X313 DOOR	£26.80	£32.60	1245 CURVE	£357.14	£399.98
355X495 DOOR	£22.86	£25.60	715X345 DOOR	£31.72	£41.68	355X795 FRAME	£61.70	£69.10
355X595 BLANK	£23.62	£26.46	715X395 DOOR	£35.14	£39.36	355X995 FRAME	£74.84	£83.82
355X595 DOOR	£27.46	£30.76	715X445 DOOR	£36.88	£41.30	715X395 FRAME	£60.68	£67.96
355X795 BLANK	£33.56	£37.58	715X495 DOOR	£40.74	£45.62	715X495 FRAME	£72.82	£81.56

MATCHING ACCESSORIES LUCENTE GLOSS GROUP A

CODE	DESCRIPTION	PRICE	CODE	DESCRIPTION	PRICE
LUC/MCOR	3M UNIVERSAL CORNICE/PELMET	£42.30	LUC/WPAN	792X350MM END PANEL	£35.90
LUC/CURCOR	UNIVERSAL EXTERNAL CURVED CORNICE	£45.92	LUC/PAN	900X650MM END PANEL	£50.54
LUC/CURPLIN	EXTERNAL CURVED PLINTH	£61.08	LUC/LAR	2400X650X22MM END PANEL	£132.52
LUC/PLIN	3050X150MM PLINTH	£43.98	LUC/18LAR	2400X650X18MM END PANEL	£137.68
LUC/CBLOC	CORNER BLOCK END PROFILE	£41.88	LUC/BBAR	2400X900MM END PANEL	£233.40
LUC/CUREND	2400MM CURVED END POST	£108.24	LUC/POST	SLAB CORNER POST	£38.82
LUC/SHPOST	715X60MM SHAPED CORNER POST	£45.66	LUC/EXPOST	EXTERNAL CORNER POST	£46.76

MATCHING ACCESSORIES LUCENTE GROUP B

CODE	DESCRIPTION	PRICE	CODE	DESCRIPTION	PRICE
LUCBL/MCOR	3M UNIVERSAL CORNICE/PELMET	£47.38	LUCBL/WPAN	792X350MM END PANEL	£40.20
LUCBL/CURCOR	UNIVERSAL EXTERNAL CURVED CORNICE	£51.42	LUCBL/PAN	900X650MM END PANEL	£56.60
LUCBL/CURPLIN	EXTERNAL CURVED PLINTH	£68.40	LUCBL/LAR	2400X650X22MM END PANEL	£146.03
LUCBL/PLIN	3050X150MM PLINTH	£49.26	LUCBL/18LAR	2400X650X18MM END PANEL	£154.20
LUCBL/CBLOCK	CORNER BLOCK END PROFILE	£46.90	LUCBL/BBAR	2400X900MM END PANEL	£261.40
LUCBL/CUREND	2400MM CURVED END POST	£121.22	LUCBL/POST	SLAB CORNER POST	£43.48
LUCBL/SHPOST	715X60MM SHAPED CORNER POST	£51.14	LUCBL/EXPOST	EXTERNAL CORNER POST	£52.38

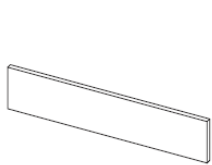

Plinth*

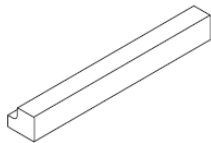

Straight Square End Cornice/Pelmet



Curved Doors
715, 895 & 1245mm heights**

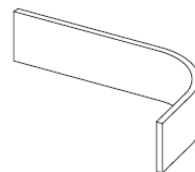

Curved Plinth

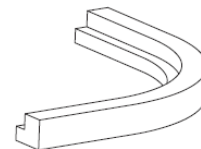

Curved Square End Cornice/Pelmet

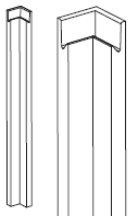

Internal Corner Post Shaped***

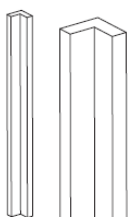

Internal Corner Post Slab***

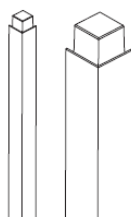

External Corner Post Shaped***



Curved End Post†



Corner Block††
(for Curved End Post)

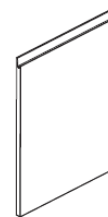

End Panel Shaped

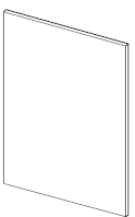

End Panel Slab

LUCENTE MATTE (2 WEEK LEAD TIME)



Lucente Matte is a J profile door with integrated handle. This range is manufactured using MDF, which is then painted to a soft sheen finish.



**ANTHRACITE
GROUP B**



**DUST GREY
GROUP A**

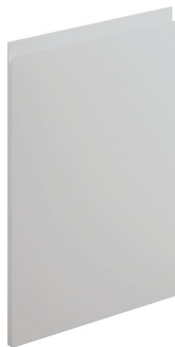

**LIGHT GREY
GROUP A**

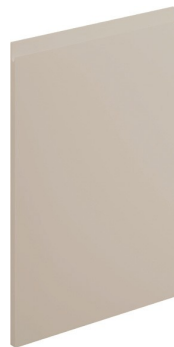

**STONE
GROUP A**

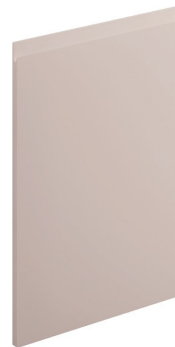

**CASHMERE
GROUP A**



**WHITE
GROUP A**

LUCENTE MATTE A & B

SIZE	PRICE A	PRICE B	SIZE	PRICE A	PRICE B	SIZE	PRICE A	PRICE B
110X595 BLANK	£8.32	£9.32	355X795 DOOR	£28.64	£32.08	715X545 DOOR	£48.56	£54.38
140X295 DRAWER	£6.40	£7.16	355X895 BLANK	£31.96	£35.80	715X595 DOOR	£40.18	£45.00
140X395 DRAWER	£8.00	£8.96	355X895 DOOR	£31.96	£35.80	895X295 DOOR	£31.52	£35.30
140X445 DRAWER	£8.78	£9.84	355X995 BLANK	£35.32	£39.56	895X395 DOOR	£39.24	£43.94
140X495 DRAWER	£9.58	£10.72	355X995 DOOR	£35.32	£39.56	895X445 DOOR	£43.12	£48.28
140X595 DRAWER	£11.16	£12.50	450X595 DOOR	£27.06	£30.30	895X495 DOOR	£47.06	£52.70
140X795 DRAWER	£14.30	£16.02	490X595 DOOR	£29.08	£32.56	895X595 DOOR	£54.70	£61.26
140X895 DRAWER	£15.88	£17.78	570X295 DOOR	£17.64	£19.76	980X595 DOOR	£59.24	£66.34
140X995 DRAWER	£17.46	£19.56	570X395 DOOR	£22.72	£25.44	1245X255 DOOR	£48.82	£54.68
175X395 DRAWER	£8.82	£9.88	570X445 DOOR	£25.26	£28.28	1245X295 DOOR	£42.06	£47.10
175X495 DRAWER	£11.04	£12.36	570X495 DOOR	£27.78	£31.12	1245X395 DOOR	£52.58	£58.88
175X595 DRAWER	£12.92	£14.46	570X595 DOOR	£32.84	£36.78	1245X445 DOOR	£56.78	£63.60
283X495 DOOR	£15.62	£17.50	645X595 DOOR	£36.64	£41.04	1245X495 DOOR	£63.14	£70.72
283X595 DOOR	£18.38	£20.58	715X145 DOOR	£12.08	£13.52	1245X595 DOOR	£73.68	£82.52
283X795 DOOR	£23.84	£26.70	715X255 DOOR	£19.00	£21.28	1965X595 DOOR	£126.62	£141.82
283X895 DOOR	£26.60	£29.80	715X273 DOOR	£46.48	£26.04	715 CURVE	£192.44	£215.54
283X995 DOOR	£29.32	£32.84	715X295 DOOR	£21.46	£24.04	895 CURVE	£264.48	£296.22
355X495 BLANK	£18.68	£20.92	715X313 DOOR	£25.36	£28.40	1245 CURVE	£346.94	£388.58
355X495 DOOR	£18.68	£20.92	715X345 DOOR	£24.48	£27.42	355X795 FRAME	£59.70	£66.86
355X595 BLANK	£22.00	£24.64	715X395 DOOR	£27.66	£30.98	355X995 FRAME	£72.84	£81.58
355X595 DOOR	£22.00	£24.64	715X445 DOOR	£30.80	£34.50	715X395 FRAME	£58.68	£65.72
355X795 BLANK	£28.64	£32.08	715X495 DOOR	£33.90	£37.96	715X495 FRAME	£70.82	£79.32

MATCHING ACCESSORIES LUCENTE MATTE GROUP A

CODE	DESCRIPTION	PRICE	CODE	DESCRIPTION	PRICE
LUCMAT/MCOR	3M UNIVERSAL CORNICE/PELMET	£41.10	LUCMAT/WPAN	792X350MM END PANEL	£34.88
LUCMAT/CURCOR	UNIVERSAL EXTERNAL CURVED CORNICE	£43.92	LUCMAT/PAN	900X650MM END PANEL	£49.10
LUCMAT/CURPLIN	EXTERNAL CURVED PLINTH	£59.08	LUCMAT/LAR	2400X650X22MM END PANEL	£141.85
LUCMAT/PLIN	3050X150MM PLINTH	£43.10	LUCMAT/18LAR	2400X650X18MM END PANEL	£133.74
LUCMAT/CBLOCK	CORNER BLOCK END PROFILE	£40.70	LUCMAT/BBAR	2400X900MM END PANEL	£226.72
LUCMAT/CUREND	2400MM CURVED END POST	£105.16	LUCMAT/POST	SLAB CORNER POST	£45.42
LUCMAT/SHPOST	715X60MM SHAPED CORNER POST	£44.36	LUCMAT/EXPOST	EXTERNAL CORNER POST	£48.09

MATCHING ACCESSORIES LUCENTE MATT GROUP B

CODE	DESCRIPTION	PRICE	CODE	DESCRIPTION	PRICE
LMANTH/MCOR	3M UNIVERSAL CORNICE/PELMET	£46.04	LMANTH/WPAN	792X350MM END PANEL	£39.06
LMANTH/CURCOR	UNIVERSAL EXTERNAL CURVED CORNICE	£49.18	LMANTH/PAN	900X650MM END PANEL	£55.00
LMANTH/CURPLIN	EXTERNAL CURVED PLINTH	£66.16	LMANTH/LAR	2400X650X22MM END PANEL	£171.25
LMANTH/PLIN	3050X150MM PLINTH	£48.28	LMANTH/18LAR	2400X650X18MM END PANEL	£149.78
LMANTH/CBLOCK	CORNER BLOCK END PROFILE	£45.58	LMANTH/BBAR	2400X900MM END PANEL	£259.92
LMANTH/CUREND	2400MM CURVED END POST	£117.78	LMANTH/POST	SLAB CORNER POST	£50.88
LMANTH/SHPOST	715X60MM SHAPED CORNER POST	£49.68	LMANTH/EXPOST	EXTERNAL CORNER POST	£57.09

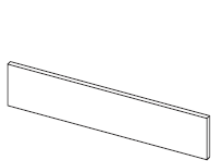

Plinth*

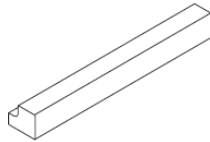

Straight Square End Cornice/Pelmet



Curved Doors
715, 895 & 1245mm heights**

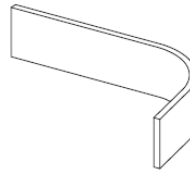

Curved Plinth

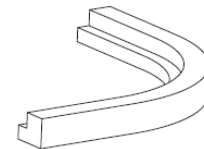

Curved Square End Cornice/Pelmet

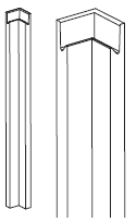

Internal Corner Post Shaped***

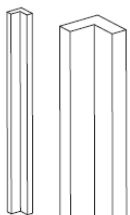

Internal Corner Post Slab***

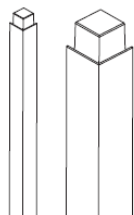

External Corner Post Shaped***



Curved End Post†



Corner Block††
(for Curved End Post)

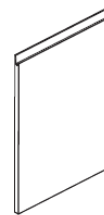

End Panel Shaped

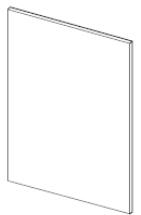

End Panel Slab

CAMBRIDGE SHAKER (2 WEEK LEAD TIME)



Cambridge Shaker is available in either a solid oak lacquered finish, or a Solid ash painted to 5 stock colours. Cambridge is constructed using a solid timber frame with a veneered MDF centre panel. Cambridge has a stylish V groove added to the 4 joints in its frame.



DUST GREY



LIGHT GREY



MUSSEL



IVORY



IVORY

CAMBRIDGE SHAKER

SIZE	PRICE	SIZE	PRICE	SIZE	PRICE	SIZE	PRICE
110X595 BLANK	£18.86	283X895 DOOR	£46.46	715X145 DOOR	£30.18	895X595 DOOR	£82.98
140X295 DRAWER	£15.48	283X995 DOOR	£47.06	715X255 DOOR	£46.46	980X595 DOOR	£88.66
140X395 DRAWER	£18.20	355X495 DOOR	£35.92	715X277 DOOR	£47.76	1245X255 DOOR	£61.90
140X445 DRAWER	£19.00	355X595 DOOR	£40.42	715X295 DOOR	£40.60	1245X295 DOOR	£63.26
140X495 DRAWER	£20.06	355X795 DOOR	£50.50	715X313 DOOR	£42.72	1245X395 DOOR	£77.32
140X595 DRAWER	£22.60	355X895 DOOR	£55.00	715X345 DOOR	£45.18	1245X495 DOOR	£91.20
140X795 DRAWER	£29.42	355X995 DOOR	£59.48	715X395 DOOR	£47.82	1245X595 DOOR	£103.84
140X895 DRAWER	£32.96	450X595 DOOR	£47.02	715X445 DOOR	£50.68	715 CURVE	£108.02
140X995 DRAWER	£35.58	490X595 DOOR	£48.82	715X495 DOOR	£51.46	895 CURVE	£114.02
175X395 DRAWER	£19.32	570X295 DOOR	£35.20	715X545 DOOR	£69.54	1245 CURVE	£126.02
175X495 DRAWER	£22.56	570X395 DOOR	£41.86	715X595 DOOR	£63.72	715X395 GLAZED	£80.16
175X595 DRAWER	£25.30	570X445 DOOR	£45.22	895X295 DOOR	£52.04	715X495 GLAZED	£91.60
283X495 DOOR	£32.50	570X495 DOOR	£47.10	895X395 DOOR	£62.10	715X595 GLAZED	£107.74
283X595 DOOR	£35.18	570X595 DOOR	£53.58	895X445 DOOR	£67.14	895X495 GLAZED	£106.94
283X795 DOOR	£42.44	645X595 DOOR	£59.66	895X495 DOOR	£70.56	1060X495 GLAZED	£120.96

MATCHING ACCESSORIES

CODE	DESCRIPTION	PRICE	CODE	DESCRIPTION	PRICE
CAM/MCOR	UNIVERSAL 3M CORNICE/PELMET	£31.58	CAM/WPAN	792X350MM END PANEL	£28.46
CAM/MCURCOR	UNIVERSAL EXTERNAL CURVED CORNICE	£133.42	CAM/TGW PAN	792X350MM T&G END PANEL	£34.94
CAM/COR	3M TANGENT CORNICE	£37.32	CAM/PAN	900X650MM END PANEL	£46.60
CAM/CURCOR	EXTERNAL CURVED TANGENT CORNICE	£105.38	CAM/TGPAN	900X650MM T&G END PANEL	£61.58
CAM/PEL	3M TANGENT PELMET	£35.04	CAM/LAR	2400X650MM END PANEL	£116.50
CAM/CURPEL	EXTERNAL CURVED PELMET	£81.24	CAM/TGLAR	2400X650MM T&G END PANEL	£148.11
CAM/PLIN	2800X150MM PLINTH	£41.66	CAM/900TG	900X2100MM T&G END PANEL	£218.08
CAM/CURPLIN	EXTERNAL CURVED PLINTH	£80.52	CAM/PLATE	1200MM PLATE RACK	£202.32
CAM/CENDCOR	CURVE CORNICE BLOCK	£23.80	CAM/BOTTLE	1500MM BOTTLE RACK	£33.20
CAM/CEND	2400X100X50MM CURVED END PILLAR	£71.96	CAM/COL	950X80X80MM FLOOR COLUMN	£98.40
CAM/PIL	2400X100X50MM STRAIGHT END PILLAR	£71.96	CAM/BPIL	950X100MM BARREL PILASTER	£96.14
CAM/POST	715X70MM CORNER POST	£27.21	CAM/MANTEL	COMPLETE MANTEL KIT	£365.46

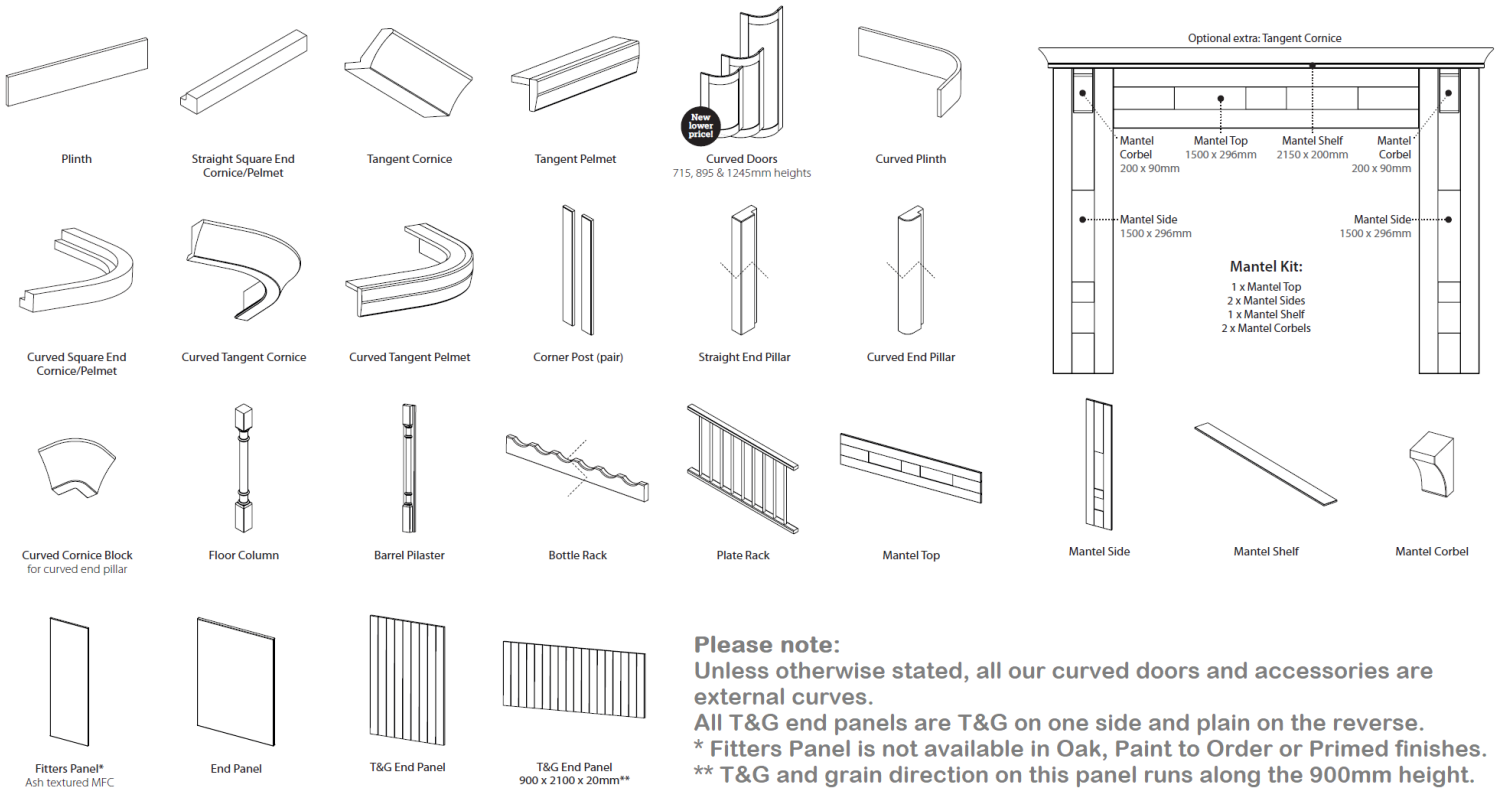

WINDSOR BEADED (2 WEEK LEAD TIME)



Windsor Beaded is available in either a solid oak lacquered finish, or a Solid ash painted to 4 stock colours. Windsor is constructed using a solid timber frame with a veneered MDF centre panel. Windsor has a stylish V groove added to the 4 joints in its frame.



DUST GREY



LIGHT GREY



MUSSEL



IVORY



OAK

WINDSOR BEADED

SIZE	PRICE	SIZE	PRICE	SIZE	PRICE	SIZE	PRICE
110X595 BLANK	£18.86	283X895 DOOR	£46.46	715X145 DOOR	£30.18	895X595 DOOR	£82.98
140X295 DRAWER	£15.48	283X995 DOOR	£47.06	715X255 DOOR	£46.46	980X595 DOOR	£88.66
140X395 DRAWER	£18.20	355X495 DOOR	£35.92	715X277 DOOR	£47.76	1245X255 DOOR	£61.90
140X445 DRAWER	£19.00	355X595 DOOR	£40.42	715X295 DOOR	£40.60	1245X295 DOOR	£63.26
140X495 DRAWER	£20.06	355X795 DOOR	£50.50	715X313 DOOR	£42.72	1245X395 DOOR	£77.32
140X595 DRAWER	£22.60	355X895 DOOR	£55.00	715X345 DOOR	£45.18	1245X495 DOOR	£91.20
140X795 DRAWER	£29.42	355X995 DOOR	£59.48	715X395 DOOR	£47.82	1245X595 DOOR	£103.84
140X895 DRAWER	£32.96	450X595 DOOR	£47.02	715X445 DOOR	£50.68	715 CURVE	£108.02
140X995 DRAWER	£35.58	490X595 DOOR	£48.82	715X495 DOOR	£51.46	895 CURVE	£114.02
175X395 DRAWER	£19.32	570X295 DOOR	£35.20	715X545 DOOR	£69.54	1245 CURVE	£126.02
175X495 DRAWER	£22.56	570X395 DOOR	£41.86	715X595 DOOR	£63.72	715X395 GLAZED	£80.16
175X595 DRAWER	£25.30	570X445 DOOR	£45.22	895X295 DOOR	£52.04	715X495 GLAZED	£91.60
283X495 DOOR	£32.50	570X495 DOOR	£47.10	895X395 DOOR	£62.10	715X595 GLAZED	£107.74
283X595 DOOR	£35.18	570X595 DOOR	£53.58	895X445 DOOR	£67.14	895X495 GLAZED	£106.94
283X795 DOOR	£42.44	645X595 DOOR	£59.66	895X495 DOOR	£70.56	1060X495 GLAZED	£120.96

MATCHING ACCESSORIES

CODE	DESCRIPTION	PRICE	CODE	DESCRIPTION	PRICE
WIND/MCOR	UNIVERSAL 3M CORNICE/PELMET	£31.58	WIND/WPAN	792X350MM END PANEL	£28.46
WIND/MCURCOR	UNIVERSAL EXTERNAL CURVED CORNICE	£133.42	WIND/TGWAN	792X350M T&G END PANEL	£34.94
WIND/COR	3M TANGENT CORNICE	£37.32	WIND/PAN	900X650MM END PANEL	£46.60
WIND/CURCOR	EXTERNAL CURVED TANGENT CORNICE	£105.38	WIND/TGPAN	900X650MM T&G END PANEL	£61.58
WIND/PEL	3M TANGENT PELMET	£35.04	WIND/LAR	2400X650MM END PANEL	£116.50
WIND/CURPEL	EXTERNAL CURVED PELMET	£81.24	WIND/TGLAR	2400X650MM T&G END PANEL	£148.11
WIND/PLIN	2800X150MM PLINTH	£41.66	WIND/900TG	900X2100MM T&G END PANEL	£218.08
WIND/CURPLIN	EXTERNAL CURVED PLINTH	£80.52	WIND/PLATE	1200MM PLATE RACK	£202.32
WIND/CENDCOR	CURVE CORNICE BLOCK	£23.80	WIND/BOTTLE	1500MM BOTTLE RACK	£33.20
WIND/CEND	2400X100X50MM CURVED END PILLAR	£71.96	WIND/COL	950X80X80MM FLOOR COLUMN	£98.40
WIND/PIL	2400X100X50MM STRAIGHT END PILLAR	£71.96	WIND/BPIL	950X100MM BARREL PILASTER	£96.14
WIND/POST	715X70MM CORNER POST	£27.21	WIND/MANTEL	COMPLETE MANTEL KIT	£365.46

Plinth

Straight Square End Cornice/Pelmet

Tangent Cornice

Tangent Pelmet

Curved Doors
715, 895 & 1245mm heights

Curved Plinth

Curved Square End Cornice/Pelmet

Curved Tangent Cornice

Curved Tangent Pelmet

Corner Post (pair)

Straight End Pillar

Curved End Pillar

Curved Cornice Block for curved end pillar

Floor Column

Barrel Pilaster

Bottle Rack

Plate Rack

Mantel Top

Mantel Side

Mantel Shelf

Mantel Corbel

Optional extra: Tangent Cornice

Mantel Kit:
1 x Mantel Top
2 x Mantel Sides
1 x Mantel Shelf
2 x Mantel Corbels

Fitters Panel*
Ash textured MFC

End Panel

T&G End Panel

T&G End Panel
900 x 2100 x 20mm**

Please note:
Unless otherwise stated, all our curved doors and accessories are external curves.
All T&G end panels are T&G on one side and plain on the reverse.
* Fitters Panel is not available in Oak, Paint to Order or Primed finishes.
** T&G and grain direction on this panel runs along the 900mm height.

CAMBRIDGE & WINDSOR PAINTED TO ORDER (4 WEEK LEAD TIME)



NEUTRALS



SUPER WHITE



WHITE



PORCELAIN



CHALKSTONE



MUSSEL

EARTHY



CASHMERE



TAUPE GREY



PEBBLE GREY



DAKAR



STONE GREY



LAVA

GREYS



WHITE GREY



ONYX GREY



SILVER GREY

BLUES & GREENS



SAGE GREEN



FRENCH GREY



FJORD



DENIM



SMOKE BLUE



MIDNIGHT BLUE



INDIGO BLUE

CAMBRIDGE PAINTED TO ORDER

SIZE	PRICE	SIZE	PRICE	SIZE	PRICE	SIZE	PRICE
110X595 BLANK	£23.56	283X895 DOOR	£57.18	715X145 DOOR	£37.72	895X595 DOOR	£103.72
140X295 DRAWER	£19.36	283X995 DOOR	£57.68	715X255 DOOR	£58.06	980X595 DOOR	£110.84
140X395 DRAWER	£22.74	355X495 DOOR	£44.90	715X277 DOOR	£59.70	1245X255 DOOR	£78.36
140X445 DRAWER	£23.76	355X595 DOOR	£50.52	715X295 DOOR	£49.84	1245X295 DOOR	£79.16
140X495 DRAWER	£25.08	355X795 DOOR	£63.12	715X313 DOOR	£53.40	1245X395 DOOR	£96.64
140X595 DRAWER	£28.24	355X895 DOOR	£68.76	715X345 DOOR	£56.50	1245X495 DOOR	£114.00
140X795 DRAWER	£36.78	355X995 DOOR	£74.36	715X395 DOOR	£59.76	1245X595 DOOR	£129.80
140X895 DRAWER	£37.90	450X595 DOOR	£58.78	715X445 DOOR	£63.50	715 CURVE	£135.02
140X995 DRAWER	£44.48	490X595 DOOR	£61.02	715X495 DOOR	£63.92	895 CURVE	£142.52
175X395 DRAWER	£24.14	570X295 DOOR	£44.00	715X545 DOOR	£88.76	1245 CURVE	£157.52
175X495 DRAWER	£28.20	570X395 DOOR	£52.32	715X595 DOOR	£77.84	715X395 GLAZED	£87.56
175X595 DRAWER	£31.62	570X445 DOOR	£56.52	895X295 DOOR	£65.04	715X495 GLAZED	£96.58
283X495 DOOR	£40.64	570X495 DOOR	£58.88	895X395 DOOR	£77.62	715X595 GLAZED	£104.70
283X595 DOOR	£43.98	570X595 DOOR	£66.96	895X445 DOOR	£83.94	895X495 GLAZED	£112.04
283X795 DOOR	£53.06	645X595 DOOR	£74.62	895X495 DOOR	£88.20	1060X495 GLAZED	£122.82

MATCHING ACCESSORIES

CODE	DESCRIPTION	PRICE	CODE	DESCRIPTION	PRICE
PCAM/MCOR	UNIVERSAL 3M CORNICE/PELMET	£39.48	PCAM/WPAN	792X350MM END PANEL	£35.58
PCAM/MCURECOR	UNIVERSAL EXTERNAL CURVED CORNICE	£166.78	PCAM/TGW PAN	792X350MM T&G END PANEL	£43.68
PCAM/COR	3M TANGENT CORNICE	£46.64	PCAM/PAN	900X650MM END PANEL	£58.25
PCAM/CURECOR	EXTERNAL CURVED TANGENT CORNICE	£131.72	PCAM/TGPAN	900X650MM T&G END PANEL	£76.98
PCAM/PEL	3M TANGENT PELMET	£43.80	PCAM/LAR	2400X650MM END PANEL	£145.61
PCAM/CURPEL	EXTERNAL CURVED PELMET	£101.56	PCAM/TGLAR	2400X650MM T&G END PANEL	£185.14
PCAM/PLIN	2800X150MM PLINTH	£52.08	PCAM/900TG	900X2100MM T&G END PANEL	£272.60
PCAM/CURPLIN	EXTERNAL CURVED PLINTH	£100.66	PCAM/PLATE	1200MM PLATE RACK	£252.90
PCAM/CENDCOR	CURVE CORNICE BLOCK	£29.76	PCAM/BOTTLE	1500MM BOTTLE RACK	£41.48
PCAM/CEND	2400X100X50MM CURVED END PIL-LAR	£89.94	PCAM/COL	950X80X80MM FLOOR COLUMN	£123.00
PCAM/PIL	2400X100X50MM STRAIGHT END PIL-LAR	£89.94	PCAM/BPIL	950X100MM BARREL PILASTER	£120.16
PCAM/POST	715X70MM CORNER POST	£34.00	PCAM/MANTEL	COMPLETE MANTEL KIT	£456.82

WINDSOR PAINTED TO ORDER

SIZE	PRICE	SIZE	PRICE	SIZE	PRICE	SIZE	PRICE
110X595 BLANK	£23.56	283X895 DOOR	£57.18	715X145 DOOR	£37.72	895X595 DOOR	£103.72
140X295 DRAWER	£19.36	283X995 DOOR	£57.68	715X255 DOOR	£58.06	980X595 DOOR	£110.84
140X395 DRAWER	£22.74	355X495 DOOR	£44.90	715X277 DOOR	£59.70	1245X255 DOOR	£78.36
140X445 DRAWER	£23.76	355X595 DOOR	£50.52	715X295 DOOR	£49.84	1245X295 DOOR	£79.16
140X495 DRAWER	£25.08	355X795 DOOR	£63.12	715X313 DOOR	£53.40	1245X395 DOOR	£96.64
140X595 DRAWER	£28.24	355X895 DOOR	£68.76	715X345 DOOR	£56.50	1245X495 DOOR	£114.00
140X795 DRAWER	£36.78	355X995 DOOR	£74.36	715X395 DOOR	£59.76	1245X595 DOOR	£129.80
140X895 DRAWER	£37.90	450X595 DOOR	£58.78	715X445 DOOR	£63.50	715 CURVE	£135.02
140X995 DRAWER	£44.48	490X595 DOOR	£61.02	715X495 DOOR	£63.92	895 CURVE	£142.52
175X395 DRAWER	£24.14	570X295 DOOR	£44.00	715X545 DOOR	£88.76	1245 CURVE	£157.52
175X495 DRAWER	£28.20	570X395 DOOR	£52.32	715X595 DOOR	£77.84	715X395 GLAZED	£87.56
175X595 DRAWER	£31.62	570X445 DOOR	£56.52	895X295 DOOR	£65.04	715X495 GLAZED	£96.58
283X495 DOOR	£40.64	570X495 DOOR	£58.88	895X395 DOOR	£77.62	715X595 GLAZED	£104.70
283X595 DOOR	£43.98	570X595 DOOR	£66.96	895X445 DOOR	£83.94	895X495 GLAZED	£112.04
283X795 DOOR	£53.06	645X595 DOOR	£74.62	895X495 DOOR	£88.20	1060X495 GLAZED	£122.82

MATCHING ACCESSORIES

CODE	DESCRIPTION	PRICE	CODE	DESCRIPTION	PRICE
PWIND/MCOR	UNIVERSAL 3M CORNICE/PELMET	£39.48	PWIND/WPAN	792X350MM END PANEL	£35.58
PWIND/MCURECOR	UNIVERSAL EXTERNAL CURVED CORNICE	£166.78	PWIND/TGW PAN	792X350MM T&G END PANEL	£43.68
PWIND/COR	3M TANGENT CORNICE	£46.64	PWIND/PAN	900X650MM END PANEL	£58.25
PWIND/CURECOR	EXTERNAL CURVED TANGENT CORNICE	£131.72	PWIND/TGPAN	900X650MM T&G END PANEL	£76.98
PWIND/PEL	3M TANGENT PELMET	£43.80	PWIND/LAR	2400X650MM END PANEL	£145.61
PWIND/CURPEL	EXTERNAL CURVED PELMET	£101.56	PWIND/TGLAR	2400X650MM T&G END PANEL	£185.14
PWIND/PLIN	2800X150MM PLINTH	£52.08	PWIND/900TG	900X2100MM T&G END PANEL	£272.60
PWIND/CURPLIN	EXTERNAL CURVED PLINTH	£100.66	PWIND/PLATE	1200MM PLATE RACK	£252.90
PWIND/CENDCOR	CURVE CORNICE BLOCK	£29.76	PWIND/BOTTLE	1500MM BOTTLE RACK	£41.48
PWIND/CEND	2400X100X50MM CURVED END PIL-LAR	£89.94	PWIND/COL	950X80X80MM FLOOR COLUMN	£123.00
PWIND/PIL	2400X100X50MM STRAIGHT END PIL-LAR	£89.94	PWIND/BPIL	950X100MM BARREL PILASTER	£120.16
PWIND/POST	715X70MM CORNER POST	£34.00	PWIND/MANTEL	COMPLETE MANTEL KIT	£456.82

MORNINGTON SHAKER (2 WEEK LEAD TIME)



Mornington Shaker is a solid ash shaker with a veneered MDF centre panel. The frame is constructed with flush joints, giving a seamless effect once they are painted. This range is available in 6 stock colours as illustrated.



GRAPHITE



DUST GREY



STONE



DOVE GREY



PARTRIDGE GREY



PORCELAIN

MORNINGTON SHAKER							
SIZE	PRICE	SIZE	PRICE	SIZE	PRICE	SIZE	PRICE
110X595 BLANK	£21.82	283X995 DOOR	£59.96	645X595 DOOR	£61.32	895X445 DOOR	£71.44
140X295 DRAWER	£15.98	355X295 DOOR	£33.88	715X145 DOOR	£31.72	895X495 DOOR	£76.66
140X395 DRAWER	£19.30	355X495 DOOR	£41.88	715X255 DOOR	£43.62	895X595 DOOR	£87.18
140X445 DRAWER	£20.44	355X595 DOOR	£46.22	715X277 DOOR	£46.22	980X595 DOOR	£93.76
140X495 DRAWER	£21.04	355X795 DOOR	£58.84	715X295 DOOR	£48.74	1245X295 DOOR	£70.56
140X595 DRAWER	£23.62	355X895 DOOR	£63.20	715X313 DOOR	£49.62	1245X395 DOOR	£84.06
140X795 DRAWER	£31.18	355X995 DOOR	£67.54	715X325 DOOR	£54.14	1245X495 DOOR	£98.32
140X895 DRAWER	£33.82	450X595 DOOR	£54.80	715X345 DOOR	£51.92	1245X595 DOOR	£112.56
140X995 DRAWER	£36.44	490X395 DOOR	£45.98	715X395 DOOR	£55.72	1965X295 DOOR	£130.66
175X495 DRAWER	£24.58	490X595 DOOR	£59.22	715X445 DOOR	£58.90	1965X595 DOOR	£238.10
175X595 DRAWER	£27.64	570X295 DOOR	£41.74	715X495 DOOR	£61.02	715 CURVE	£316.80
283X495 DOOR	£38.24	570X395 DOOR	£48.40	715X545 DOOR	£64.52	715X395 GLAZED	£78.32
283X595 DOOR	£41.96	570X445 DOOR	£51.84	715X595 DOOR	£70.82	715X495 GLAZED	£83.96
283X795 DOOR	£50.84	570X495 DOOR	£54.56	895X295 DOOR	£56.10	895X495 GLAZED	£98.58
283X895 DOOR	£55.76	570X595 DOOR	£61.32	895X395 DOOR	£67.84		

MATCHING ACCESSORIES (* ONLY LACQUERED OAK FINISH)

CODE	DESCRIPTION	PRICE	CODE	DESCRIPTION	PRICE
MORN/COR	3M CORNICE	£62.12	MORN/WEND	774X370MM END PANEL	£34.86
MORN/CURCOR	EXTERNAL CURVED CORNICE	£124.94	MORN/TGWEND	774X370MM T&G END PANEL	£39.83
MORN/PEL	3M PELMET	£41.16	MORN/TWEND	954X370MM END PANEL	£36.67
MORN/CURPEL	EXTERNAL CURVED PELMET	£61.04	MORN/TGTWEND	954X370MM T&G END PANEL	£41.64
MORN/PLIN	3M PLINTH	£50.93	MORN/PAN	900X650MM END PANEL	£59.61
MORN/CURPLIN	EXTERNAL CURVED PLINTH	£77.80	MORN/TGPAN	900X650MM T&G END PANEL	£72.22
MORN/LBLOC	CORNICE CORNER BLOCK LEFT HAND	£42.59	MORN/LAR	2400X650MM END PANEL	£149.00
MORN/RBLOC	CORNICE CORNER BLOCK RIGHT HAND	£42.59	MORN/TGLAR	2400X650MM T&G END PANEL	£179.21
MORN/ERAD	2400X75X50MM CURVED END RADIUS	£233.27	MORN/BBAR	900X2400MM END PANEL	£224.86
MORN/ESQUARE	2400X75X50MM STRAIGHT END RADIUS	£176.59	MORN/1200PAN	900X1200MM END PANEL	£101.07
MORN/PROF	1500X36X20MM FRAME PROFILE	£24.46	MORN/PLATE	1200X336X20MM PLATE RACK*	£61.03
MORN/CPOST	715X70X20MM CORNER POST	£23.83	MORN/BOTTLE	1200X58X20MM BOTTLE RACK*	£36.85
MORN/MANTEL	COMPLETE MANTLE KIT	£1274.61	MORN/EDGE	3MX22M UNGLUED EDGING	£16.82

CORNICE

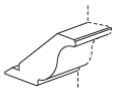

Cornice, 3030x130x36.5mm



Cornice corner block, left hand, 133x108x72mm



Cornice corner block, right hand, 133x108x72mm



Curved cornice section for 300mm wall cabinet, unhande



Light pelmet, 3030x50x28mm



Curved light pelmet section for 300mm wall cabinet, unhande



Plinth, 3030x150x16mm



Curved plinth section for 560x300mm curved base cabinet

PLINTHS

PROFILE



Frame Profile 1500x36x20mm

FEATURE POSTS

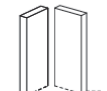

Corner post, 715x70x20



Tall square feature end, 2400x75x50mm



Tall radius feature end, 2400x75x50mm

END PANELS

↑ Indicates vertical grain direction



End panel, 900x650x18mm



Wall end panel, 774x370x18mm



Tall wall end panel, 954x370x18mm



End panel, 2400x650x18mm



End panel, T&G, 900x650x18mm

OVER MANTEL



FULL MANTEL

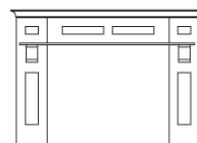

TIMBER ACCESSORIES



Bottle rack, 1200x58x20mm, (Natural Oak finish)



Plate rack, 1200x336mm, (Natural Oak finish)



Wall end panel, T&G, 74x370x18mm



Tall wall end panel, T&G, 954x370x18mm



End panel, T&G, 2400x650x18mm

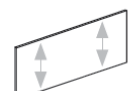

Breakfast bar back panel, 900x2400x18mm - grain runs in 900mm direction



Breakfast bar panel, 900x1200x18mm

MORNINGTON BEADED (2 WEEK LEAD TIME)



Mornington Beaded is a solid ash shaker with a veneered MDF centre panel. The frame is constructed with flush joints, giving a seamless effect once they are painted. This range is available in 6 stock colours as illustrated.



GRAPHITE



DUST GREY



STONE



DOVE GREY



PARTRIDGE GREY



PORCELAIN

MORNINGTON BEADED

SIZE	PRICE	SIZE	PRICE	SIZE	PRICE	SIZE	PRICE
110X595 BLANK	£21.82	283X995 DOOR	£59.96	645X595 DOOR	£61.32	895X445 DOOR	£71.44
140X295 DRAWER	£15.98	355X295 DOOR	£33.88	715X145 DOOR	£31.72	895X495 DOOR	£76.66
140X395 DRAWER	£19.30	355X495 DOOR	£41.88	715X255 DOOR	£43.62	895X595 DOOR	£87.18
140X445 DRAWER	£20.44	355X595 DOOR	£46.22	715X277 DOOR	£46.22	980X595 DOOR	£93.76
140X495 DRAWER	£21.04	355X795 DOOR	£58.84	715X295 DOOR	£48.74	1245X295 DOOR	£70.56
140X595 DRAWER	£23.62	355X895 DOOR	£63.20	715X313 DOOR	£49.62	1245X395 DOOR	£84.06
140X795 DRAWER	£31.18	355X995 DOOR	£67.54	715X325 DOOR	£54.14	1245X495 DOOR	£98.32
140X895 DRAWER	£33.82	450X595 DOOR	£54.80	715X345 DOOR	£51.92	1245X595 DOOR	£112.56
140X995 DRAWER	£36.44	490X395 DOOR	£45.98	715X395 DOOR	£55.72	1965X295 DOOR	£130.66
175X495 DRAWER	£24.58	490X595 DOOR	£59.22	715X445 DOOR	£58.90	1965X595 DOOR	£238.10
175X595 DRAWER	£27.64	570X295 DOOR	£41.74	715X495 DOOR	£61.02	715 CURVE	£316.80
283X495 DOOR	£38.24	570X395 DOOR	£48.40	715X545 DOOR	£64.52	715X395 GLAZED	£78.32
283X595 DOOR	£41.96	570X445 DOOR	£51.84	715X595 DOOR	£70.82	715X495 GLAZED	£83.96
283X795 DOOR	£50.84	570X495 DOOR	£54.56	895X295 DOOR	£56.10	895X495 GLAZED	£98.58
283X895 DOOR	£55.76	570X595 DOOR	£61.32	895X395 DOOR	£67.84		

MATCHING ACCESSORIES (*OAK FINISH)

CODE	DESCRIPTION	PRICE	CODE	DESCRIPTION	PRICE
MORB/COR	3M CORNICE	£62.12	MORB/WEND	774X370MM END PANEL	£34.86
MORB/CURCOR	EXTERNAL CURVED CORNICE	£124.94	MORB/TGWEND	774X370MM T&G END PANEL	£39.83
MORB/PEL	3M PELMET	£41.16	MORB/TWEND	954X370MM END PANEL	£36.67
MORB/CURPEL	EXTERNAL CURVED PELMET	£61.04	MORB/TGTWEND	954X370MM T&G END PANEL	£41.64
MORB/PLIN	3M PLINTH	£50.93	MORB/PAN	900X650MM END PANEL	£59.61
MORB/CURPLIN	EXTERNAL CURVED PLINTH	£77.80	MORB/TGPAN	900X650MM T&G END PANEL	£72.22
MORB/LBLOC	CORNICE CORNER BLOCK LEFT HAND	£42.59	MORB/LAR	2400X650MM END PANEL	£149.00
MORB/RBLOC	CORNICE CORNER BLOCK RIGHT HAND	£42.59	MORB/TGLAR	2400X650MM T&G END PANEL	£179.21
MORB/ERAD	2400X75X50MM CURVED END RADIUS	£233.27	MORB/BBAR	900X2400MM END PANEL	£224.86
MORB/ESQUARE	2400X75X50MM STRAIGHT END RADIUS	£176.59	MORB/1200PAN	900X1200MM END PANEL	£101.07
MORB/PROF	1500X36X20MM FRAME PROFILE	£24.46	MORB/PLATE	1200X336X20MM PLATE RACK*	£61.03
MORB/CPOST	715X70X20MM CORNER POST	£23.83	MORB/BOTTLE	1200X58X20MM BOTTLE RACK*	£36.85
MORB/MANTEL	COMPLETE MANTLE KIT	£1274.61	MORB/EDGE	3MX22M UNGLUED EDGING	£16.82

CORNICE

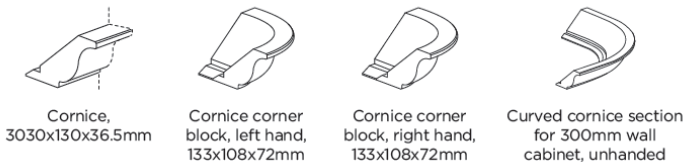

PLINTHS

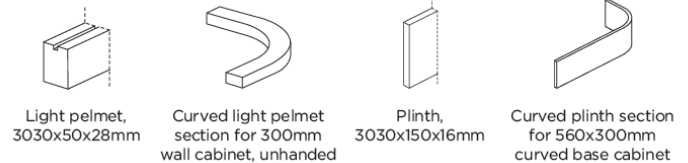

PROFILE

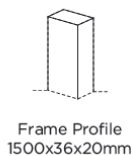

FEATURE POSTS

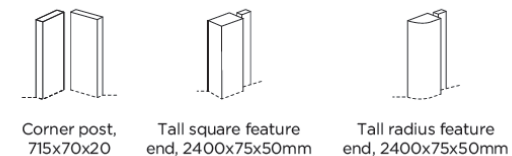

END PANELS

↑ Indicates vertical grain direction

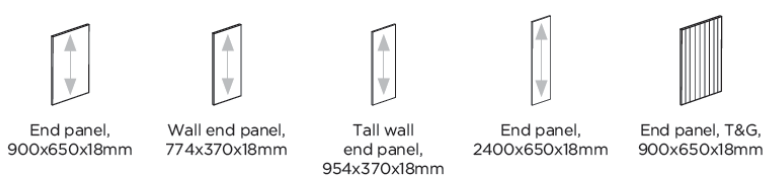

OVER MANTEL



FULL MANTEL

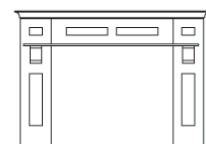

TIMBER ACCESSORIES

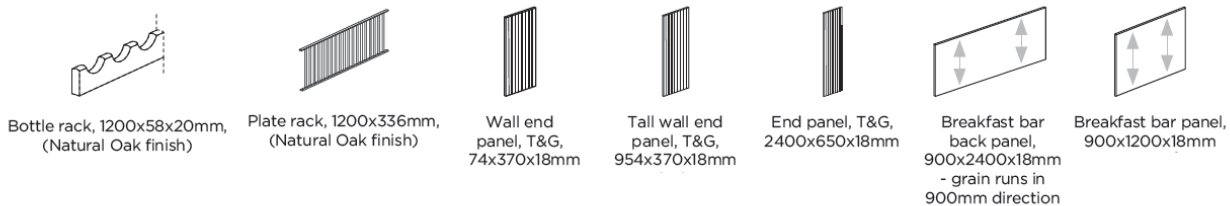

MORNINGTON PAINT TO ORDER (5 WEEK LEAD TIME)



Mornington Shaker & Mornington Beaded are both available in a variety of painted to order finishes.

LIGHTS/WHITES	GREYS	WARM NEUTRALS	GREENS	BLUES
 CHALK	 DOVE GREY	 CASHMERE	 SAGE	 CHINA BLUE
 PORCELAIN	 PARTRIDGE GREY	 DRY ROSE	 FLINT GREY	 CHALK BLUE
 ALABASTER MODERN	 SILVER GREY	 STONE	 TRENCH COAT GREY	 CADET
 MUSSEL	 DUST GREY	 PUTTY	 REGIMENT	 CORNFLOWER
	 SLATE	 SUEDE	 COPSE GREEN	 STORM BLUE
	 GRAPHITE	 TRUFFLE		 HARTFORTH BLUE
	 CARBON	 LAVA		 CHARCOAL

**COLOUR
PALETTE**



MORNINGTON SHAKER PAINTED TO ORDER

SIZE	PRICE	SIZE	PRICE	SIZE	PRICE	SIZE	PRICE
110X595 BLANK	£26.18	283X995 DOOR	£71.96	645X595 DOOR	£77.58	895X445 DOOR	£85.74
140X295 DRAWER	£19.16	355X295 DOOR	£40.66	715X145 DOOR	£38.06	895X495 DOOR	£91.98
140X395 DRAWER	£23.16	355X495 DOOR	£50.26	715X255 DOOR	£52.36	895X595 DOOR	£104.60
140X445 DRAWER	£24.52	355X595 DOOR	£55.46	715X277 DOOR	£55.46	980X595 DOOR	£112.50
140X495 DRAWER	£25.26	355X795 DOOR	£70.62	715X295 DOOR	£58.48	1245X295 DOOR	£84.66
140X595 DRAWER	£28.34	355X895 DOOR	£75.84	715X313 DOOR	£59.54	1245X395 DOOR	£100.88
140X795 DRAWER	£37.42	355X995 DOOR	£81.04	715X325 DOOR	£64.96	1245X495 DOOR	£117.98
140X895 DRAWER	£40.58	450X595 DOOR	£65.78	715X345 DOOR	£62.30	1245X595 DOOR	£144.14
140X995 DRAWER	£43.72	490X395 DOOR	£54.82	715X395 DOOR	£66.86	1965X295 DOOR	£156.80
175X495 DRAWER	£29.50	490X595 DOOR	£71.08	715X445 DOOR	£70.68	1965X595 DOOR	£285.72
175X595 DRAWER	£33.16	570X295 DOOR	£50.08	715X495 DOOR	£73.22	715 CURVE	£380.16
283X495 DOOR	£45.88	570X395 DOOR	£58.08	715X545 DOOR	£77.42	715X395 GLAZED	£94.34
283X595 DOOR	£50.36	570X445 DOOR	£62.20	715X595 DOOR	£84.98	715X495 GLAZED	£100.76
283X795 DOOR	£61.02	570X495 DOOR	£65.46	895X295 DOOR	£67.32	895X495 GLAZED	£118.28
283X895 DOOR	£66.92	570X595 DOOR	£73.58	895X395 DOOR	£81.42		

MATCHING ACCESSORIES (* LACQUERED OAK FINISH ONLY)

CODE	DESCRIPTION	PRICE	CODE	DESCRIPTION	PRICE
PMORN/COR	3M CORNICE	£74.55	PMORN/WEND	774X370MM END PANEL	£20.91
PMORN/CURCOR	EXTERNAL CURVED CORNICE	£149.93	PMORN/TGWEND	774X370MM T&G END PANEL	£47.80
PMORN/PEL	3M PELMET	£49.39	PMORN/TWEND	954X370MM END PANEL	£44.00
PMORN/CURPEL	EXTERNAL CURVED PELMET	£73.24	PMORN/TGTWEND	954X370MM T&G END PANEL	£50.00
PMORN/PLIN	3M PLINTH	£61.12	PMORN/PAN	900X650MM END PANEL	£71.53
PMORN/CURPLIN	EXTERNAL CURVED PLINTH	£93.34	PMORN/TGPAN	900X650MM T&G END PANEL	£86.66
PMORN/LBLOC	CORNICE CORNER BLOCK LEFT HAND	£51.10	PMORN/LAR	2400X650MM END PANEL	£178.79
PMORN/RBLOC	CORNICE CORNER BLOCK RIGHT HAND	£51.10	PMORN/TGLAR	2400X650MM T&G END PANEL	£215.05
PMORN/ERAD	2400X75X50MM CURVED END RADIUS	£211.91	PMORN/BBAR	900X2400MM END PANEL	£269.84
PMORN/ESQUARE	2400X75X50MM STRAIGHT END RADIUS	£279.93	PMORN/1200PAN	900X1200MM END PANEL	£121.28
PMORN/CPOST	715X70X20MM CORNER POST	£28.59	PMORN/PLATE	1200X336X20MM PLATE RACK*	£57.30
PMORN/MANTLE	COMPLETE MANTLE KIT	£1274.63	PMORN/BOTTLE	1200X58X20MM BOTTLE RACK*	£47.12

MORNINGTON BEADED PAINTED TO ORDER

SIZE	PRICE	SIZE	PRICE	SIZE	PRICE	SIZE	PRICE
110X595 BLANK	£26.18	283X995 DOOR	£71.96	645X595 DOOR	£77.58	895X445 DOOR	£85.74
140X295 DRAWER	£19.16	355X295 DOOR	£40.66	715X145 DOOR	£38.06	895X495 DOOR	£91.98
140X395 DRAWER	£23.16	355X495 DOOR	£50.26	715X255 DOOR	£52.36	895X595 DOOR	£104.60
140X445 DRAWER	£24.52	355X595 DOOR	£55.46	715X277 DOOR	£55.46	980X595 DOOR	£112.50
140X495 DRAWER	£25.26	355X795 DOOR	£70.62	715X295 DOOR	£58.48	1245X295 DOOR	£84.66
140X595 DRAWER	£28.34	355X895 DOOR	£75.84	715X313 DOOR	£59.54	1245X395 DOOR	£100.88
140X795 DRAWER	£37.42	355X995 DOOR	£81.04	715X325 DOOR	£64.96	1245X495 DOOR	£117.98
140X895 DRAWER	£40.58	450X595 DOOR	£65.78	715X345 DOOR	£62.30	1245X595 DOOR	£144.14
140X995 DRAWER	£43.72	490X395 DOOR	£54.82	715X395 DOOR	£66.86	1965X295 DOOR	£156.80
175X495 DRAWER	£29.50	490X595 DOOR	£71.08	715X445 DOOR	£70.68	1965X595 DOOR	£285.72
175X595 DRAWER	£33.16	570X295 DOOR	£50.08	715X495 DOOR	£73.22	715 CURVE	£380.16
283X495 DOOR	£45.88	570X395 DOOR	£58.08	715X545 DOOR	£77.42	715X395 GLAZED	£94.34
283X595 DOOR	£50.36	570X445 DOOR	£62.20	715X595 DOOR	£84.98	715X495 GLAZED	£100.76
283X795 DOOR	£61.02	570X495 DOOR	£65.46	895X295 DOOR	£67.32	895X495 GLAZED	£118.28
283X895 DOOR	£66.92	570X595 DOOR	£73.58	895X395 DOOR	£81.42		

MATCHING ACCESSORIES (* LACQUERED OAK FINISH ONLY)

CODE	DESCRIPTION	PRICE	CODE	DESCRIPTION	PRICE
PMORB/COR	3M CORNICE	£74.55	PMORB/WEND	774X370MM END PANEL	£20.91
PMORB/CURCOR	EXTERNAL CURVED CORNICE	£149.93	PMORB/TGWEND	774X370MM T&G END PANEL	£47.80
PMORB/PEL	3M PELMET	£49.39	PMORB/TWEND	954X370MM END PANEL	£44.00
PMORB/CURPEL	EXTERNAL CURVED PELMET	£73.24	PMORB/TGTWEND	954X370MM T&G END PANEL	£50.00
PMORB/PLIN	3M PLINTH	£61.12	PMORB/PAN	900X650MM END PANEL	£71.53
PMORB/CURPLIN	EXTERNAL CURVED PLINTH	£93.34	PMORB/TGPAN	900X650MM T&G END PANEL	£86.66
PMORB/LBLOC	CORNICE CORNER BLOCK LEFT HAND	£51.10	PMORB/LAR	2400X650MM END PANEL	£178.79
PMORB/RBLOC	CORNICE CORNER BLOCK RIGHT HAND	£51.10	PMORB/TGLAR	2400X650MM T&G END PANEL	£215.05
PMORB/ERAD	2400X75X50MM CURVED END RADIUS	£211.91	PMORB/BBAR	900X2400MM END PANEL	£269.84
PMORB/ESQUARE	2400X75X50MM STRAIGHT END RADIUS	£279.93	PMORB/1200PAN	900X1200MM END PANEL	£121.28
PMORB/CPOST	715X70X20MM CORNER POST	£28.59	PMORB/PLATE	1200X336X20MM PLATE RACK*	£57.30
PMORB/MANTLE	COMPLETE MANTLE KIT	£1274.63	PMORB/BOTTLE	1200X58X20MM BOTTLE RACK*	£47.12

PORTER GLOSS (2 WEEK LEAD TIME)



Porter Gloss is a slab style door manufactured using MDF, which is then painted to the colours illustrated below. Each door is finished with a high gloss lacquer.



**This range is available
in INTEGRO cabinets**

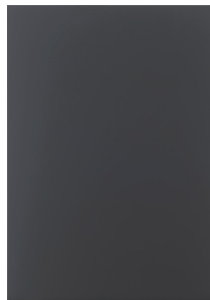

GRAPHITE

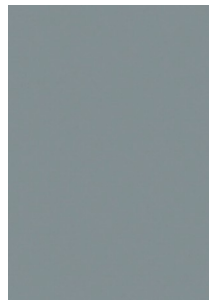

DUST GREY



SILVER GREY



DOVE GREY



CASHMERE

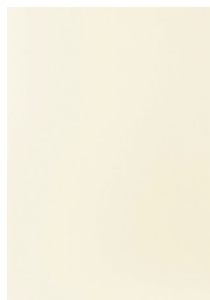

ALABASTER



PORCELAIN

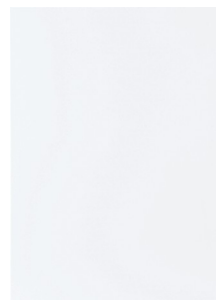

WHITE

PORTER GLOSS

SIZE	PRICE	SIZE	PRICE	SIZE	PRICE	SIZE	PRICE
110X595 BLANK	£12.25	283X895 DOOR	£31.08	570X595 DOOR	£39.38	715X545 DOOR	£46.58
140X295 DRAWER	£9.65	283X995 DOOR	£34.33	645X595 DOOR	£44.38	715X595 DOOR	£48.70
140X395 DRAWER	£10.50	325X495 DOOR	£21.85	685X145 DOOR	£15.15	895X295 DOOR	£32.38
140X445 DRAWER	£11.08	325X595 DOOR	£24.80	685X295 DOOR	£26.15	895X395 DOOR	£41.53
140X495 DRAWER	£11.70	325X795 DOOR	£30.70	685X313 DOOR	£27.00	895X445 DOOR	£46.08
140X595 DRAWER	£13.03	325X895 DOOR	£34.00	685X345 DOOR	£29.23	895X495 DOOR	£50.68
140X795 DRAWER	£16.28	325X995 DOOR	£36.93	685X395 DOOR	£32.78	895X595 DOOR	£59.85
140X895 DRAWER	£17.90	325X1195 DOOR	£44.88	685X445 DOOR	£37.00	980X595 DOOR	£65.35
140X995 DRAWER	£19.60	355X295 DOOR	£6.48	685X495 DOOR	£39.28	1245X295 DOOR	£44.08
160X495 DRAWER	£13.18	355X495 DOOR	£22.35	685X545 DOOR	£43.13	1245X395 DOOR	£56.75
160X595 DRAWER	£14.60	355X595 DOOR	£26.13	685X595 DOOR	£47.18	1245X495 DOOR	£69.48
160X795 DRAWER	£18.65	355X795 DOOR	£33.95	715X145 DOOR	£15.68	1245X595 DOOR	£82.23
160X895 DRAWER	£20.38	355X895 DOOR	£37.73	715X255 DOOR	£24.30	1965X295 DOOR	£91.25
160X995 DRAWER	£22.00	355X995 DOOR	£41.70	715X277 DOOR	£31.08	1965X495 DOOR	£132.08
160X1195 DRAWER	£26.75	450X595 DOOR	£32.00	715X295 DOOR	£26.73	1965X595 DOOR	£152.58
175X495 DRAWER	£13.20	490X595 DOOR	£34.40	715X313 DOOR	£34.23	715 CURVE	£192.70
175X595 DRAWER	£15.08	570X295 DOOR	£21.78	715X345 DOOR	£30.50	INT CURVED BASE	£197.78
283X495 DOOR	£18.70	570X395 DOOR	£27.63	715X395 DOOR	£34.03	INT CURVED WALL	£197.78
283X595 DOOR	£21.70	570X445 DOOR	£30.53	715X445 DOOR	£37.68	715X495 GLAZED	£88.58
283X795 DOOR	£28.08	570X495 DOOR	£33.48	715X495 DOOR	£41.33		

MATCHING ACCESSORIES

CODE	DESCRIPTION	PRICE	CODE	DESCRIPTION	PRICE
PORTG/MCOR	UNIVERSAL 3M CORNICE/PELMET	£49.85	PORTG/WEND	780X370X18MM END PANEL	£39.41
PORTG/CURCOR	UNIVERSAL EXTERNAL CURVED CORNICE	£71.40	PORTG/TWPAN	960X370X18MM END PANEL	£43.67
PORTG/INTCOR	UNIVERSAL INTERNAL CURVED CORNICE	£75.61	PORTG/PAN	900X650X18MM END PANEL	£62.49
PORTG/PLIN	3MX150MM PLINTH	£61.54	PORTG/LAR	2400X650X18MM END PANEL	£198.79
PORTG/CURPLIN	EXTERNAL CURVED PLINTH	£100.17	PORTG/BBAR	2400X900X18MM END PANEL	£309.90
PORTG/INTPLIN	INTERNAL CURVED PLINTH	£106.94	PORTG/685BBAR	685X1200X18MM END PANEL	£129.41
PORTG/EPOST	3000X100X50MM FEATURE END POST	£153.53	PORTG/685POST	685X46X46MM EXTERNAL CORNER POST	£53.88
PORTG/POST	715X70X18MM 2 PIECE CORNER POST	£27.15	PORTG/SPOST	685X70X18MM CORNER POST	£37.64

CORNICE



Modern cornice/light pelmet, 3050x50x28mm

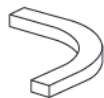

Curved cornice for the small curved door, unhandled



Internal curved cornice/light pelmet

PLINTH



Plinth, 3050x150x16mm

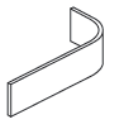

Curved plinth section for the small curved door 530x150x16mm

FEATURE POSTS

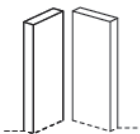

Corner post, 715x70x18mm - supplied in pairs

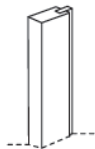

Appliance/larder feature end post, 3000x100x50mm

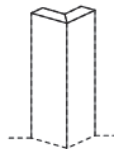

External corner post, 685x46x46mm (Handleless rail accessories)

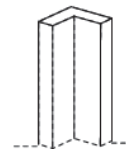

Base corner post, 685x70x18mm, slab profile (Handleless rail accessories)



Internal curved plinth

END PANELS



Base end panel, 900x650x18mm



Wall end panel, 780x370x18mm



Tall wall end panel, 960x370x18mm



End panel, 2400x650x18mm



Breakfast bar end panel, 900x2400x18mm

PORTER MATTE (2 WEEK LEAD TIME)



Porter Gloss is a slab style door manufactured using MDF, which is then painted to the colours illustrated below. Each door is finished with a high gloss lacquer.



This range is available
in **INTEGRO** cabinets

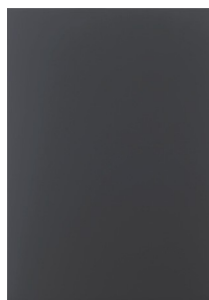

GRAPHITE

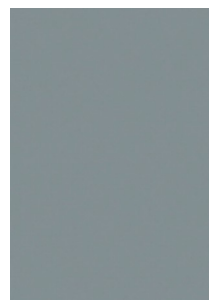

DUST GREY



SILVER GREY



DOVE GREY



CASHMERE

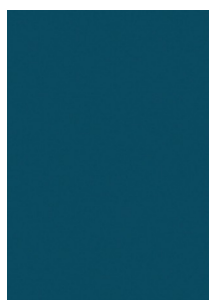

HARTFORTH
BLUE



PORCELAIN

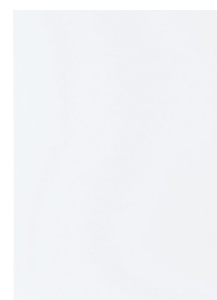

WHITE

PORTER MATTE							
SIZE	PRICE	SIZE	PRICE	SIZE	PRICE	SIZE	PRICE
110X595 BLANK	£12.25	283X895 DOOR	£31.08	570X595 DOOR	£39.38	715X545 DOOR	£46.58
140X295 DRAWER	£9.65	283X995 DOOR	£34.33	645X595 DOOR	£44.38	715X595 DOOR	£48.70
140X395 DRAWER	£10.50	325X495 DOOR	£21.85	685X145 DOOR	£15.15	895X295 DOOR	£32.38
140X445 DRAWER	£11.08	325X595 DOOR	£24.80	685X295 DOOR	£26.15	895X395 DOOR	£41.53
140X495 DRAWER	£11.70	325X795 DOOR	£30.70	685X313 DOOR	£27.00	895X445 DOOR	£46.08
140X595 DRAWER	£13.03	325X895 DOOR	£34.00	685X345 DOOR	£29.23	895X495 DOOR	£50.68
140X795 DRAWER	£16.28	325X995 DOOR	£36.93	685X395 DOOR	£32.78	895X595 DOOR	£59.85
140X895 DRAWER	£17.90	325X1195 DOOR	£44.88	685X445 DOOR	£37.00	980X595 DOOR	£65.35
140X995 DRAWER	£19.60	355X295 DOOR	£6.48	685X495 DOOR	£39.28	1245X295 DOOR	£44.08
160X495 DRAWER	£13.18	355X495 DOOR	£22.35	685X545 DOOR	£43.13	1245X395 DOOR	£56.75
160X595 DRAWER	£14.60	355X595 DOOR	£26.13	685X595 DOOR	£47.18	1245X495 DOOR	£69.48
160X795 DRAWER	£18.65	355X795 DOOR	£33.95	715X145 DOOR	£15.68	1245X595 DOOR	£82.23
160X895 DRAWER	£20.38	355X895 DOOR	£37.73	715X255 DOOR	£24.30	1965X295 DOOR	£91.25
160X995 DRAWER	£22.00	355X995 DOOR	£41.70	715X277 DOOR	£31.08	1965X495 DOOR	£132.08
160X1195 DRAWER	£26.75	450X595 DOOR	£32.00	715X295 DOOR	£26.73	1965X595 DOOR	£152.58
175X495 DRAWER	£13.20	490X595 DOOR	£34.40	715X313 DOOR	£34.23	715 CURVE	£192.70
175X595 DRAWER	£15.08	570X295 DOOR	£21.78	715X345 DOOR	£30.50	INT CURVED BASE	£197.78
283X495 DOOR	£18.70	570X395 DOOR	£27.63	715X395 DOOR	£34.03	INT CURVED WALL	£197.78
283X595 DOOR	£21.70	570X445 DOOR	£30.53	715X445 DOOR	£37.68	715X495 GLAZED	£88.58
283X795 DOOR	£28.08	570X495 DOOR	£33.48	715X495 DOOR	£41.33		

MATCHING ACCESSORIES (*VERTICAL HANDLE **PORTER PANELS)

CODE	DESCRIPTION	PRICE	CODE	DESCRIPTION	PRICE
PORTM/MCOR	UNIVERSAL 3M CORNICE/PELMET	£49.85	PORTM/WEND	780X370X18MM END PANEL	£39.41
PORTM/CURCOR	UNIVERSAL EXTERNAL CURVED CORNICE	£71.40	PORTM/TWPAN	960X370X18MM END PANEL	£43.67
PORTM/INTCOR	UNIVERSAL INTERNAL CURVED CORNICE	£75.61	PORTM/PAN	900X650X18MM END PANEL	£62.49
PORTM/PLIN	3MX150MM PLINTH	£61.54	PORTM/LAR	2400X650X18MM END PANEL	£198.79
PORTM/CURPLIN	EXTERNAL CURVED PLINTH	£100.17	PORTM/BBAR	2400X900X18MM END PANEL	£309.90
PORTM/INTPLIN	INTERNAL CURVED PLINTH	£106.94	PORTM/685BBAR	685X1200X18MM END PANEL	£129.41
PORTM/EPOST	3000X100X50MM FEATURE END POST	£153.53	PORTM/685POST	685X46X46MM EXTERNAL CORNER POST	£53.88
PORTM/POST	715X70X18MM 2 PIECE CORNER POST	£27.15	PORTM/SPOST	685X70X18MM INTERNAL CORNER POST	£37.64

CORNICE



Modern cornice/light pelmet, 3050x50x28mm

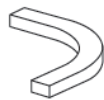

Curved cornice for the small curved door, unhandled

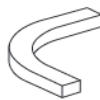

Internal curved cornice/light pelmet

PLINTH



Plinth, 3050x150x16mm

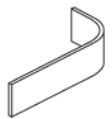

Curved plinth section for the small curved door 530x150x16mm

FEATURE POSTS

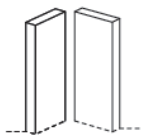

Corner post, 715x70x18mm - supplied in pairs

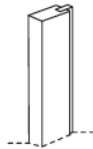

Appliance/larder feature end post, 3000x100x50mm

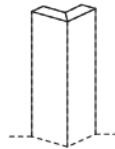

External corner post, 685x46x46mm (Handleless rail accessories)

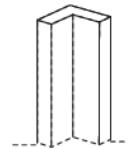

Base corner post, 685x70x18mm, slab profile (Handleless rail accessories)



Internal curved plinth

END PANELS



Base end panel, 900x650x18mm



Wall end panel, 780x370x18mm



Tall wall end panel, 960x370x18mm



End panel, 2400x650x18mm



Breakfast bar end panel, 900x2400x18mm

REMO GLOSS (2 WEEK LEAD TIME)



Remo Gloss is a J profile door with integrated handle. This range is manufactured using MDF, which is then painted and lacquered to a high gloss finish.

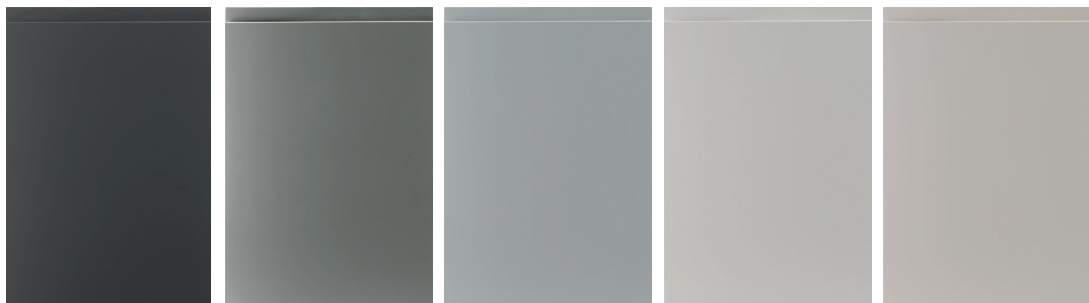

GRAPHITE

DUST GREY

SILVER GREY

DOVE GREY

CASHMERE



BEIGE

ALABASTER

PORCELAIN

WHITE

REMO GLOSS

SIZE	PRICE	SIZE	PRICE	SIZE	PRICE	SIZE	PRICE
110X595 BLANK	£17.93	355X295 DOOR	£8.68	570X595 DOOR	£50.40	895X445 DOOR	£60.33
140X295 DRAWER	£15.70	355X495 DOOR	£33.70	645X595 DOOR	£54.95	895X495 DOOR	£65.48
140X395 DRAWER	£16.25	355X595 DOOR	£37.85	715X145 DOOR	£26.08	895X595 DOOR	£72.10
140X445 DRAWER	£17.25	355X595 BLANK	£29.53	715X255 DOOR	£35.15	980X595 DOOR	£81.68
140X495 DRAWER	£17.90	355X795 DOOR	£46.18	715X271 DOOR	£52.20	1245X295 DOOR	£57.65
140X595 DRAWER	£19.55	355X795 BLANK	£37.85	715X295 DOOR	£38.45	1245X395 DOOR	£71.88
140X795 DRAWER	£25.78	355X895 DOOR	£50.33	715X313 DOOR	£53.53	1245X495 DOOR	£81.95
140X895 DRAWER	£27.50	355X895 BLANK	£42.00	715X345 DOOR	£46.60	1245X595 DOOR	£98.43
140X995 DRAWER	£29.20	355X995 DOOR	£54.48	715X395 DOOR	£44.43	1245X295 DOOR*	£64.53
175X495 DRAWER	£20.65	355X995 BLANK	£46.18	715X445 DOOR	£50.10	1245X395 DOOR*	£78.73
175X595 DRAWER	£21.95	450X595 DOOR	£44.50	715X495 DOOR	£51.23	1245X495 DOOR*	£88.83
283X495 DOOR	£29.48	490X595 DOOR	£47.58	715X545 DOOR	£59.33	1245X595 DOOR*	£107.15
283X595 DOOR	£32.80	570X295 DOOR	£33.20	715X595 DOOR	£63.10	715 CURVE	£247.10
283X795 DOOR	£39.50	570X395 DOOR	£37.85	895X271 DOOR	£63.18	INT CURVED BASE	£231.60
283X895 DOOR	£42.85	570X445 DOOR	£43.05	895X295 DOOR	£44.98	INT CURVED WALL	224.05
283X995 DOOR	£46.20	570X495 DOOR	£44.15	895X395 DOOR	£55.20	715X495 GLAZED	£113.40

MATCHING ACCESSORIES (*VERTICAL HANDLE **PORTER PANELS)

CODE	DESCRIPTION	PRICE	CODE	DESCRIPTION	PRICE
REMOG/MCOR	UNIVERSAL 3M CORNICE/PELMET	£49.85	REMOG/WEND	780X370X18MM END PANEL **	£39.41
REMOG/CURCOR	UNIVERSAL EXTERNAL CURVE CORNICE	£71.41	REMOG/TWPAN	960X370X18MM END PANEL **	£43.67
REMOG/INTCOR	UNIVERSAL INTERNAL CURVED CONICE	£75.59	REMOG/PAN	900X650X18MM END PANEL **	£62.50
REMOG/PLIN	3M PLINTH	£61.54	REMOG/LAR	2400X650X18MM END PANEL **	£198.79
REMOG/CURPLIN	EXTERNAL CURVED PLINTH	£100.17	REMOG/22LAR	2400X650X22MM END PANEL	£220.45
REMOG/INTPLIN	INTERNAL CURVED PLINTH	£106.94	REMOG/BBAR	2400X900X18MM END PANEL	£309.90
REMOG/EPOST	3000X100X50MM FEATURE END POST	£153.33	REMOG/EXPOST	900X75X75MM EXTERNAL C/POST	£111.72
REMOG/BPOST	715X70X70M BASE CORNER POST	£43.72	REMOG/POST	715X70X22MM SLAB C/POST	£41.61
REMOG/WPOST	715X26X26MM WALL CORNER POST	£123.99	REMOG/SHPOST	715X70X22MM HANDLED C/POST	£54.65

CORNICE



Modern cornice/light pelmet, 3050x50x28mm



Curved modern cornice use with small curved doors, 300mm cabinet, unhanded



Internal curved cornice section for 600mm wall cabinet

PLINTH

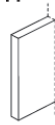

Plinth, 3050x150x16mm

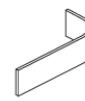

Curved plinth section use with the small curved door, 530x150x16mm



Internal curved plinth section for 900mm base cabinet

FEATURE POSTS

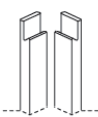

Corner post, 715x70x22mm with handle profile

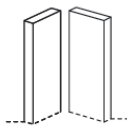

Corner post, 715x70x22mm - slab without handle profile

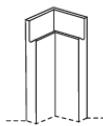

Corner post base pre assembled 715x70x70mm

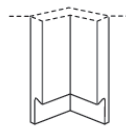

Corner post wall pre-assembled 715x26x26mm

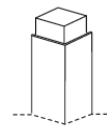

External corner post, 900x75x75mm

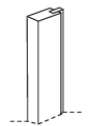

Appliance/larder feature end post, 3000x100x50mm

END PANELS



Base end panel, 900x650x18mm



Wall end panel, 780x370x18mm



Tall wall end panel, 960x370x18mm



End panel, 2400x650x18mm



End panel, 2400x650x22mm



Breakfast bar end panel, 900x2400x18mm

REMO MATTE (2 WEEK LEAD TIME)



Remo Matte is a J profile door with integrated handle. This range is manufactured using MDF, which is then painted to a soft sheen finish.



GRAPHITE

DUST GREY

SILVER GREY

DOVE GREY

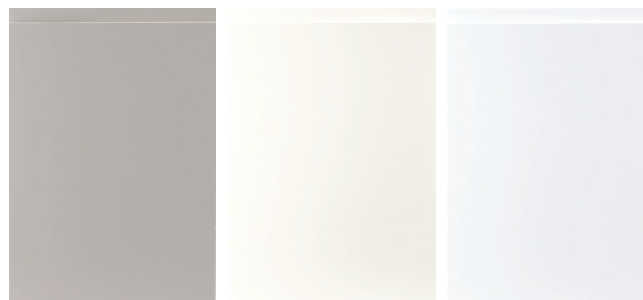

CASHMERE

PORCELAIN

WHITE

REMO MATTE							
SIZE	PRICE	SIZE	PRICE	SIZE	PRICE	SIZE	PRICE
110X595 BLANK	£17.93	355X295 DOOR	£8.68	570X595 DOOR	£50.40	895X445 DOOR	£60.33
140X295 DRAWER	£15.70	355X495 DOOR	£33.70	645X595 DOOR	£54.95	895X495 DOOR	£65.48
140X395 DRAWER	£16.25	355X595 DOOR	£37.85	715X145 DOOR	£26.08	895X595 DOOR	£72.10
140X445 DRAWER	£17.25	355X595 BLANK	£29.53	715X255 DOOR	£35.15	980X595 DOOR	£81.68
140X495 DRAWER	£17.90	355X795 DOOR	£46.18	715X271 DOOR	£52.20	1245X295 DOOR	£57.65
140X595 DRAWER	£19.55	355X795 BLANK	£37.85	715X295 DOOR	£38.45	1245X395 DOOR	£71.88
140X795 DRAWER	£25.78	355X895 DOOR	£50.33	715X313 DOOR	£53.53	1245X495 DOOR	£81.95
140X895 DRAWER	£27.50	355X895 BLANK	£42.00	715X345 DOOR	£46.60	1245X595 DOOR	£98.43
140X995 DRAWER	£29.20	355X995 DOOR	£54.48	715X395 DOOR	£44.43	1245X295 DOOR*	£64.53
175X495 DRAWER	£20.65	355X995 BLANK	£46.18	715X445 DOOR	£50.10	1245X395 DOOR*	£78.73
175X595 DRAWER	£21.95	450X595 DOOR	£44.50	715X495 DOOR	£51.23	1245X495 DOOR*	£88.83
283X495 DOOR	£29.48	490X595 DOOR	£47.58	715X545 DOOR	£59.33	1245X595 DOOR*	£107.15
283X595 DOOR	£32.80	570X295 DOOR	£33.20	715X595 DOOR	£63.10	715 CURVE	£247.10
283X795 DOOR	£39.50	570X395 DOOR	£37.85	895X271 DOOR	£63.18	INT CURVED BASE	£231.60
283X895 DOOR	£42.85	570X445 DOOR	£43.05	895X295 DOOR	£44.98	INT CURVED WALL	224.05
283X995 DOOR	£46.20	570X495 DOOR	£44.15	895X395 DOOR	£55.20	715X495 GLAZED	£113.40

MATCHING ACCESSORIES (*OAK FINISH)

CODE	DESCRIPTION	PRICE	CODE	DESCRIPTION	PRICE
REMOM/MCOR	UNIVERSAL 3M CORNICE/PELMET	£49.85	REMOM/WEND	780X370X18MM END PANEL**	£39.41
REMOM/CURCOR	UNIVERSAL EXTERNAL CURVE CORNICE	£71.41	REMOM/TWPAN	960X370X18MM END PANEL**	£43.67
REMOM/INTCOR	UNIVERSAL INTERNAL CURVED CONICE	£75.59	REMOM/PAN	900X650X18MM END PANEL**	£62.50
REMOM/PLIN	3M PLINTH	£61.54	REMOM/LAR	2400X650X18MM END PANEL**	£198.79
REMOM/CURPLIN	EXTERNAL CURVED PLINTH	£100.17	REMOM/22LAR	2400X650X22MM END PANEL	£220.45
REMOM/INTPLIN	INTERNAL CURVED PLINTH	£106.94	REMOM/BBAR	2400X900X18MM END PANEL	£309.90
REMOM/EPOST	3000X100X50MM FEATURE END POST	£153.33	REMOM/EXPOST	900X75X75MM EXTERNAL C/POST	£111.72
REMOM/BPOST	715X70X70M BASE CORNER POST	£43.72	REMOM/POST	715X70X22MM SLAB C/POST	£41.61
REMOM/WPOST	715X26X26MM WALL CORNER POST	£123.99	REMOM/SHPOST	715X70X22MM HANDLED C/POST	£54.65

CORNICE

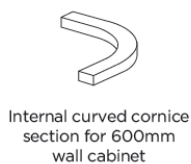
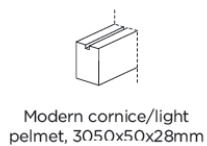

PLINTH

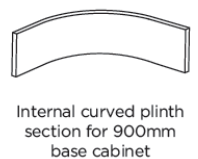
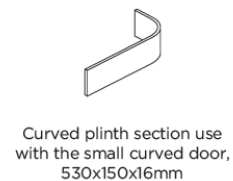
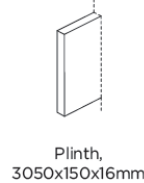

FEATURE POSTS

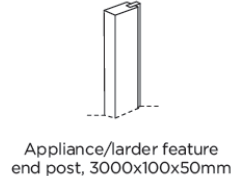
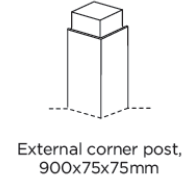
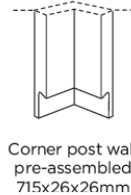
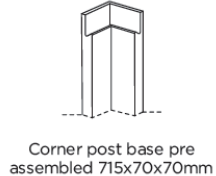
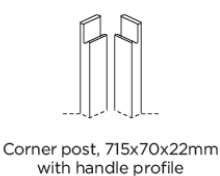

END PANELS

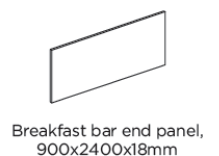
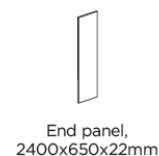
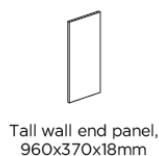
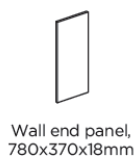
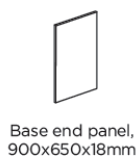

FITZROY (2 WEEK LEAD TIME)



Fitzroy is an MDF shaker-style door, which is painted to 7 stock colours.

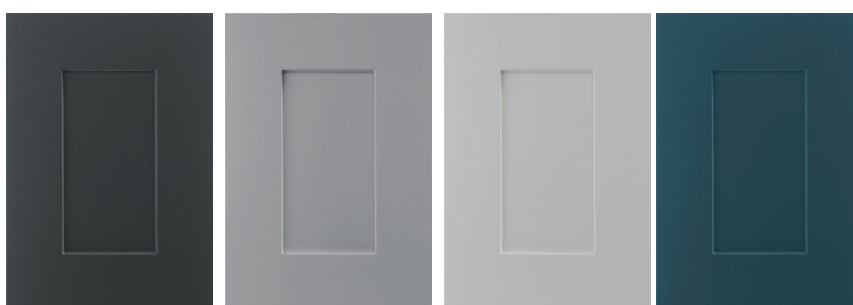

GRAPHITE

DUST GREY

DOVE GREY

HARTFORTH
BLUE

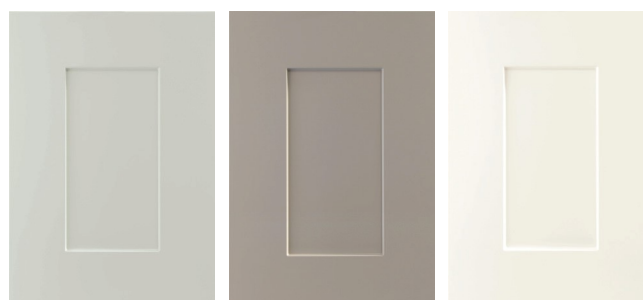

PARTRIDGE
GREY

STONE

PORCELAIN

FITZROY

SIZE	PRICE	SIZE	PRICE	SIZE	PRICE	SIZE	PRICE
110X595 BLANK	£16.95	283X995 DOOR	£49.92	645X595 DOOR	£65.73	895X445 DOOR	£69.66
140X295 DRAWER	£12.50	355X295 DOOR	£21.34	715X145 DOOR	£21.52	895X495 DOOR	£75.60
140X395 DRAWER	£14.74	355X495 DOOR	£34.38	715X255 DOOR	£35.57	895X595 DOOR	£89.31
140X445 DRAWER	£15.88	355X595 DOOR	£39.86	715X277 DOOR	£37.99	980X595 DOOR	£97.82
140X495 DRAWER	£17.01	355X795 DOOR	£50.78	715X295 DOOR	£39.94	1245X295 DOOR	£64.16
140X595 DRAWER	£19.28	355X895 DOOR	£56.24	715X313 DOOR	£42.13	1245X395 DOOR	£83.24
140X795 DRAWER	£23.14	355X995 DOOR	£61.66	715X325 DOOR	£44.27	1245X495 DOOR	£102.31
140X895 DRAWER	£25.31	450X595 DOOR	£48.55	715X345 DOOR	£45.40	1245X595 DOOR	£121.34
140X995 DRAWER	£27.49	490X395 DOOR	£37.21	715X395 DOOR	£50.92	1965X295 DOOR	£103.95
175X495 DRAWER	£19.34	490X595 DOOR	£52.21	715X445 DOOR	£56.39	1965X595 DOOR	£180.89
175X595 DRAWER	£22.11	570X295 DOOR	£33.33	715X495 DOOR	£60.90	715 CURVE	£262.52
283X495 DOOR	£28.46	570X395 DOOR	£42.02	715X545 DOOR	£69.47	320X395 GLAZED	£49.37
283X595 DOOR	£32.76	570X445 DOOR	£46.41	715X595 DOOR	£71.76	320X495 GLAZED	54.26
283X795 DOOR	£41.31	570X495 DOOR	£50.82	895X295 DOOR	£48.20	715X395 GLAZED	£79.42
283X895 DOOR	£45.63	570X595 DOOR	£59.54	895X395 DOOR	£61.89	715X495 GLAZED	£94.33

MATCHING ACCESSORIES (**OAK FINISH)

CODE	DESCRIPTION	PRICE	CODE	DESCRIPTION	PRICE
FITZ/COR	TANGENT 3 M CORNICE	£83.33	FITZ/WEND	774X370X18MM END PANEL	£47.05
FITZ/CURCOR	TANGENT EXT CURVED CORNICE	£150.69	FITZ/TWEND	954X370X18MM END PANEL	£49.40
FITZ/PEL	3M PELMET	£44.54	FITZ/PAN	900X650X18MM END PANEL	£78.46
FITZ/CURPEL	EXTERNAL CURVED PELMET	£70.29	FITZ/LAR	2400X650X18MM END PANEL	£217.02
FITZ/MCOR	UNIVERSAL 3M CORNICE/PELMET	£43.06	FITZ/28LAR	2400X650X28MM END PANEL	£321.05
FITZ/MCURCOR	UNIVERSAL EXTERNAL CURVE CORNICE	£92.97	FITZ/TGLAR	2400X650X18MM T+G END PAN	£269.19
FITZ/PLIN	3M PLINTH	£44.73	FITZ/BBAR	2400X900X18MM END PANEL	£267.31
FITZ/CURPLIN	EXTERNAL CURVED PLINTH	£73.23	FITZ/TGBBAR	2400X900X18MM T+G END PAN	£331.94
FITZ/ERAD	2400X100X50MM RADIUS FEATURE END POST	£77.57	FITZ/FWPAN	772X345X18MM FRAMED WALL END PANEL	£57.88
FITZ/ESQUARE	2400X100X50MM SQUARE FEATURE END POST	£80.64	FITZ/FTWPAN	952X345X18MM FRAMED TALL WALL END PANEL	£69.33
FITZ/CBLOC	CORNICE CORNER BLOCK USE WITH FEATURE END POSTS	£79.39	FITZ/FPAN	895X605X18MM FRAMED BASE END PANEL	£108.52
FITZ/LBLOC	LEFT CORNICE CORNER BLOCK USE WITH FEATURE POSTS	£77.03	FITZ/FDPAN	1210X345X18MM FRAMED DRESSER END PANEL	£85.79
FITZ/RBLOC	RIGHT CORNICE CORNER BLOCK USE WITH FEATURE POSTS	£77.03	FITZ/LEND	2145X605X18MM FRAMED APPLIANCE END PANEL LEFT	£292.59
FITZ/BPROF	2000X74X28MM BULLNOSE PROFILE	£39.46	FITZ/REND	2145X605X18MM FRAMED APPLIANCE END PANEL RIGHT	£292.59
FITZ/BBLOC	BULLNOSED PROFILE CORNER BLOCK	£27.53	FITZ/FLY	2400X325X28MM FLYSHELF	£202.46
FITZ/CPOST	715X70X18MM CORNER POST	£26.13	FITZ/MANTEL	FULL MANTLE KIT	£1161.09
FITZ/BOTTLE	1200X58X20MM BOTTLE RACK**	£55.27	FITZ/CORB	CORBEL 175X115X155MM	£164.07
FITZ/PLATE	1200X336MM PLATE RACK**	£67.22	FITZ/SBRAC	FEATURE SHELF BRACKET**	£41.26

CORNICE

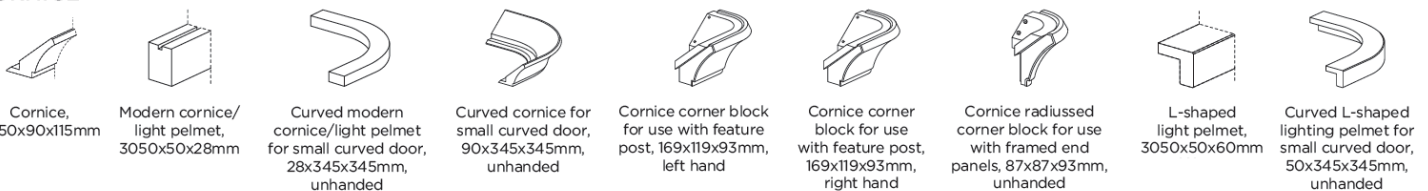

END PANELS

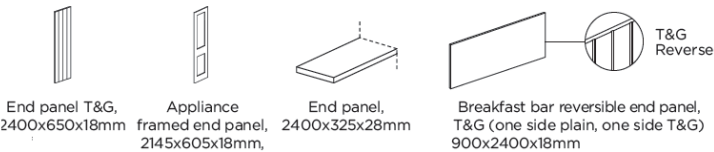
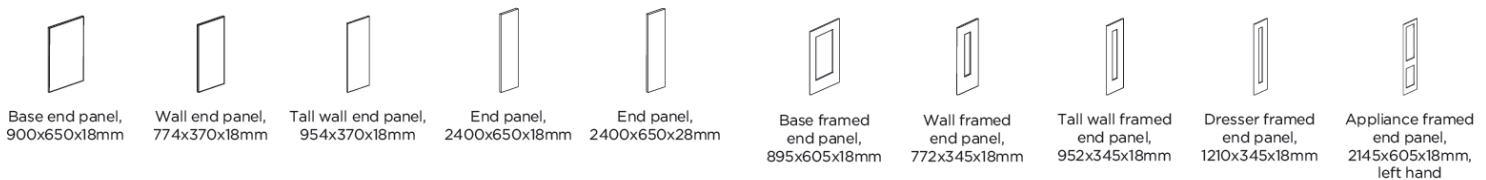

FEATURE POSTS

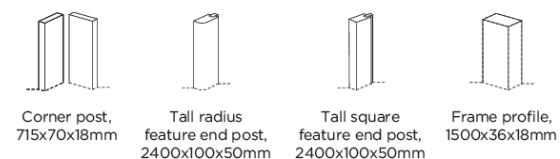

PLINTHS



MANTEL KITS

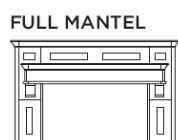
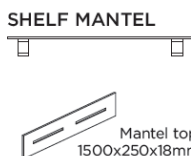

MANTEL PRODUCTS



FITZROY PAINT TO ORDER (5 WEEK LEAD TIME)



Fitzroy Painted to order is an MDF shaker-style door, which is painted to any of the colours below.

LIGHTS/WHITES	GREYS	WARM NEUTRALS	GREENS	BLUES
 CHALK	 DOVE GREY	 CASHMERE	 SAGE	 CHINA BLUE
 PORCELAIN	 PARTRIDGE GREY	 DRY ROSE	 FLINT GREY	 CHALK BLUE
 ALABASTER MODERN	 SILVER GREY	 STONE	 TRENCH COAT GREY	 CADET
 MUSSEL	 DUST GREY	 PUTTY	 REGIMENT	 CORNFLOWER
	 SLATE	 SUEDE	 COPSE GREEN	 STORM BLUE
	 GRAPHITE	 TRUFFLE		 HARTFORTH BLUE
	 CARBON	 LAVA		 CHARCOAL

**COLOUR
PALETTE**



FITZROY PAINTED

SIZE	PRICE	SIZE	PRICE	SIZE	PRICE	SIZE	PRICE
110X595 BLANK	£20.35	283X995 DOOR	£59.91	645X595 DOOR	£78.88	895X445 DOOR	£83.60
140X295 DRAWER	£14.95	355X295 DOOR	£25.62	715X145 DOOR	£25.83	895X495 DOOR	£90.74
140X395 DRAWER	£17.70	355X495 DOOR	£41.26	715X255 DOOR	£42.67	895X595 DOOR	£107.18
140X445 DRAWER	£19.05	355X595 DOOR	£47.84	715X277 DOOR	£45.57	980X595 DOOR	£117.37
140X495 DRAWER	£20.41	355X795 DOOR	£60.94	715X295 DOOR	£47.92	1245X295 DOOR	£76.99
140X595 DRAWER	£23.14	355X895 DOOR	£67.49	715X313 DOOR	£50.55	1245X395 DOOR	£99.90
140X795 DRAWER	£27.76	355X995 DOOR	£74.00	715X325 DOOR	£53.13	1245X495 DOOR	£122.77
140X895 DRAWER	£30.39	450X595 DOOR	£58.28	715X345 DOOR	£54.47	1245X595 DOOR	£145.59
140X995 DRAWER	£32.99	490X395 DOOR	£44.67	715X395 DOOR	£61.11	1965X295 DOOR	£124.76
175X495 DRAWER	£23.20	490X595 DOOR	£62.64	715X445 DOOR	£67.66	1965X595 DOOR	£217.08
175X595 DRAWER	£26.54	570X295 DOOR	£39.98	715X495 DOOR	£73.08	715 CURVE	£315.02
283X495 DOOR	£34.15	570X395 DOOR	£50.42	715X545 DOOR	£83.37	320X395 GLAZED	£59.24
283X595 DOOR	£39.31	570X445 DOOR	£55.71	715X595 DOOR	£86.10	320X495 GLAZED	£65.10
283X795 DOOR	£49.56	570X495 DOOR	£60.98	895X295 DOOR	£57.83	715X395 GLAZED	£95.32
283X895 DOOR	£54.77	570X595 DOOR	£71.46	895X395 DOOR	£74.28	715X495 GLAZED	£113.19

MATCHING ACCESSORIES (**OAK FINISH)

CODE	DESCRIPTION	PRICE	CODE	DESCRIPTION	PRICE
FITZ/COR	TANGENT 3 M CORNICE	£99.99	FITZ/WEND	774X370X18MM END PANEL	£56.47
FITZ/CURCOR	TANGENT EXT CURVED CORNICE	£180.82	FITZ/TWPAN	954X370X18MM END PANEL	£59.28
FITZ/PEL	3M PELMET	£53.47	FITZ/PAN	900X650X18MM END PANEL	£94.16
FITZ/CURPEL	EXTERNAL CURVED PELMET	£84.35	FITZ/LAR	2400X650X18MM END PANEL	£260.43
FITZ/MCOR	UNIVERSAL 3M CORNICE/PELMET	£51.68	FITZ/28LAR	2400X650X28MM END PANEL	£385.27
FITZ/MCURCOR	UNIVERSAL EXTERNAL CURVE CORNICE	£111.57	FITZ/TGLAR	2400X650X18MM T+G END PAN	£323.03
FITZ/PLIN	3M PLINTH	£53.69	FITZ/BBAR	2400X900X18MM END PANEL	£320.68
FITZ/CURPLIN	EXTERNAL CURVED PLINTH	£87.86	FITZ/TGBBAR	2400X900X18MM T+G END PAN	£398.45
FITZ/ERAD	2400X100X50MM RADIUS FEATURE END POST	£93.09	FITZ/FWPAN	772X345X18MM FRAMED WALL END PANEL	£69.46
FITZ/ESQUARE	2400X100X50MM SQUARE FEATURE END POST	£96.77	FITZ/FTWPAN	952X345X18MM FRAMED TALL WALL END PANEL	£83.20
FITZ/CBLOC	CORNICE CORNER BLOCK USE WITH FEATURE END POSTS	£95.27	FITZ/FPAN	895X605X18MM FRAMED BASE END PANEL	£130.22
FITZ/LBLOC	LEFT CORNICE CORNER BLOCK USE WITH FEATURE POSTS	£92.43	FITZ/FDPAN	1210X345X18MM FRAMED DRESSER END PANEL	£102.94
FITZ/RBLOC	RIGHT CORNICE CORNER BLOCK USE WITH FEATURE POSTS	£92.43	FITZ/LEND	2145X605X18MM FRAMED APPLIANCE END PANEL LEFT	£351.12
FITZ/BPROF	2000X74X28MM BULLNOSE PROFILE	£47.36	FITZ/REND	2145X605X18MM FRAMED APPLIANCE END PANEL RIGHT	£351.12
FITZ/BBLOC	BULLNOSED PROFILE CORNER BLOCK	£33.03	FITZ/FLY	2400X325X28MM FLYSHELF	£242.96
FITZ/CPOST	715X70X18MM CORNER POST	£31.36	FITZ/CORB	CORBEL 175X115X155MM	£196.90
FITZ/MANTEL	FITZ/MANTEL	£1393.31			

CORNICE



END PANELS

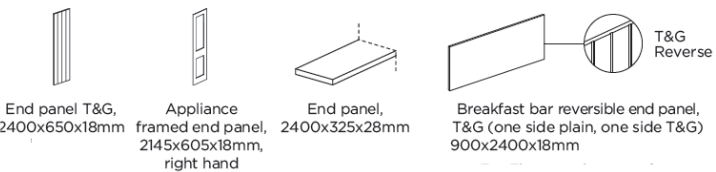
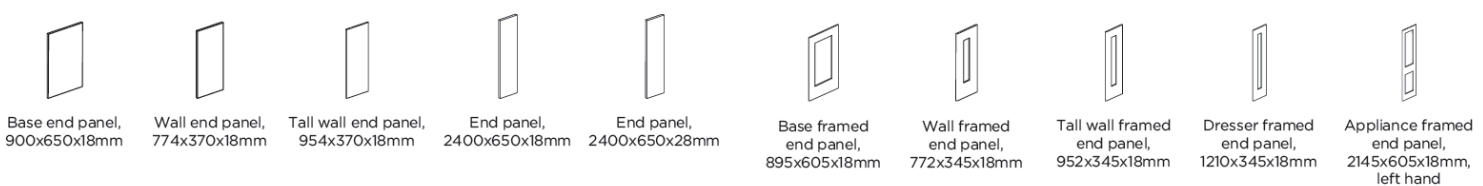

FEATURE POSTS

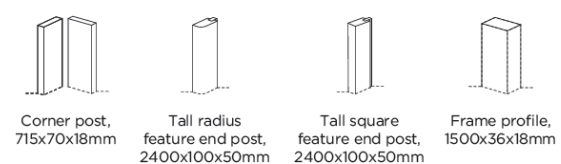

PLINTHS



MANTEL KITS

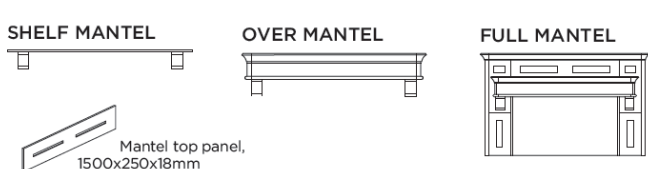

MANTEL PRODUCTS

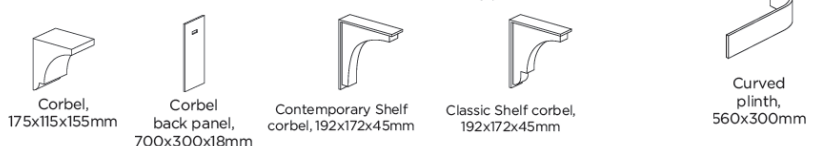

ASHBURY FOUNDATION (3 WEEK LEAD TIME)



Ashbury is a solid ash shaker with a veneered MDF centre panel. The frame is constructed with flush joints, giving a seamless effect once they are painted. This range is available painted to order in 7 popular colours, at a more competitive price point.

Foundation Colours available in block finish only.



Graphite



Dust Grey



Light Grey



Sheffield Blue



Cashmere



Alabaster F104



Mussel



Porcelain



Light Grey

Ashbury Foundation colour palette is available in 7 colours.



The contours of the oak graining are still visible, but the overall effect is far more 'block'.

The natural wood is first primed, and then covered with two coats of paint.

FOUNDATION ASHBURY							
SIZE	PRICE	SIZE	PRICE	SIZE	PRICE	SIZE	PRICE
110X595 BLANK	£21.78	283X895 DOOR	£55.00	570X495 DOOR	£54.38	895X395 DOOR	£65.64
140X295 DRAWER	£16.42	283X995 DOOR	£58.94	570X595 DOOR	£61.44	895X445 DOOR	£69.14
140X395 DRAWER	£19.08	355X495 DOOR	£43.34	645X595 DOOR	£71.18	895X495 DOOR	£74.26
140X445 DRAWER	£21.02	355X595 DOOR	£47.78	715X145 DOOR	£28.26	895X595 DOOR	£84.34
140X495 DRAWER	£21.76	355X795 DOOR	£60.94	715X255 DOOR	£49.86	980X595 DOOR	£90.84
140X595 DRAWER	£24.48	355X895 DOOR	£65.56	715X295 DOOR	£51.28	1245X295 DOOR	£68.76
140X795 DRAWER	£30.02	355X995 DOOR	£69.86	715X313 DOOR	£51.48	1245X395 DOOR	£81.24
140X895 DRAWER	£32.64	450X595 DOOR	£55.16	715X345 DOOR	£53.56	1245X495 DOOR	£95.30
140X995 DRAWER	£35.84	495X395 DOOR	£57.86	715X395 DOOR	£56.08	1245X595 DOOR	£109.02
175X495 DRAWER	£25.36	495X595 DOOR	£57.86	715X445 DOOR	£58.62	715 CURVE	£311.42
175X595 DRAWER	£28.52	520X595 DOOR	£61.44	715X495 DOOR	£61.26	895 CURVE	£390.92
283X495 DOOR	£39.46	570X295 DOOR	£44.30	715X545 DOOR	£71.18	715X395 GLAZED	£87.90
283X595 DOOR	£43.46	570X395 DOOR	£48.70	715X595 DOOR	£71.18	715X495 GLAZED	£90.80
283X795 DOOR	£51.16	570X445 DOOR	£52.06	895X295 DOOR	£57.98	1060X495 GLAZED	£110.36

MATCHING ACCESSORIES					
CODE	DESCRIPTION	PRICE	CODE	DESCRIPTION	PRICE
FASH/COR	3M SHAKER CORNICE	£56.00	FASH/WPAN	965X350X19MM END PANEL	£69.00
FASH/CURCOR	EXTERNAL CURVED CORNICE	£80.00	FASH/PAN	900X650X19MM END PANEL	£83.00
FASH/PEL	3M VENEER PELMET	£56.00	FASH/LAR	2440X650X19MM END PANEL	£141.00
FASH/CURPEL	EXTERNAL CURVED PELMET	£51.00	FASH/150PAN	900X1500X19MM END PANEL	£162.00
FASH/PLIN	PLINTH 3M	£62.00	FASH/TGPAN	900X650X19MM T+G END PAN	£158.00
FASH/CURPLIN	EXTERNAL CURVED PLINTH	£71.00	FASH/TGLAR	2440X650X19MM T+G END PAN	£269.00
FASH/QCOL	2420X100X100 1/4 ROUND COLUMN	£261.00	FASH/150TGPAN	900X1500X19MM T+G END PAN	£269.00
FASH/CCAP	100X100 CORNICE 1/4 ROUND CAP	£80.00	FASH/MANTLE	COMPLETE OVER MANTLE KIT	£313.00
FASH/BPIL	2420X100X50MM BLOCK PILASTER	£104.00	FASH/PLATE	PLATE RACK LADDER RAIL	£104.00
FASH/880PIL	880X100X100MM SOLID BLOCK PILASTER	£123.00	FASH/WINE	WINE RACK BOTTLE LADDER FRONT & BACK	£129.00
FASH/900PIL	900X50X50MM SOLID BLOCK PILASTER	£64.00			

CORNICE

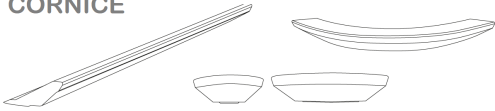

PELMET

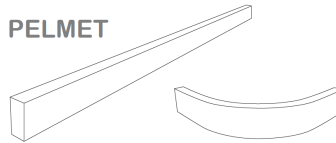

PANELS

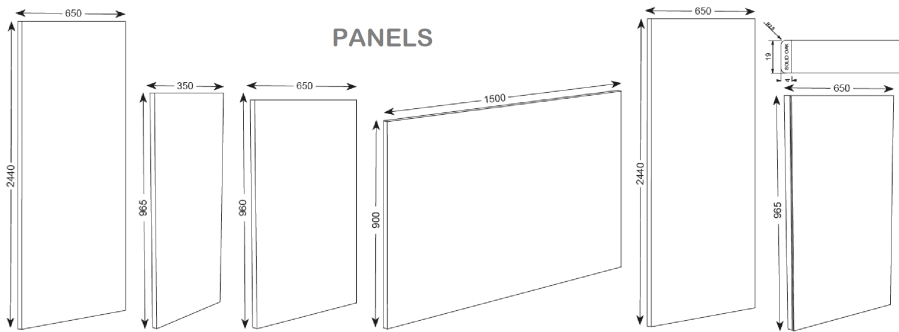

PILASTERS



MANTLE

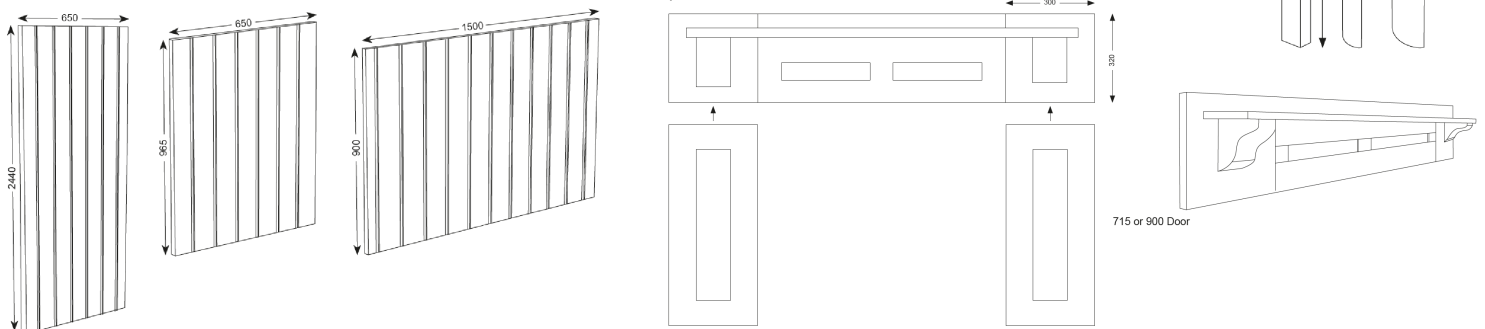

ASHBURY PAINTED TO ORDER (4 WEEK LEAD TIME)



Ashbury Painted is a solid ash shaker with a veneered MDF centre panel. The frame is constructed with flush joints, giving a seamless effect once they are painted. This range is available painted to order in colours shown within the illustrated palette.

Ashbury Painted



Carbon



Dust Grey



Cedar



Stepping Stone



Pebble



English Grey



Light Grey



Deep Ocean



Lead



Silt



Heather



Edwardian Blue



Fjord



Bluebell



English Blue



Sage



Truffle



Sahara



Edwardian White



Cashmere



Mussel



Ivory



Alabaster

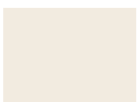

Snowdrop

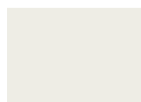

Porcelain

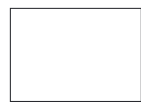

White

ASHBURY PAINTED

SIZE	PRICE	SIZE	PRICE	SIZE	PRICE	SIZE	PRICE
110X595 BLANK	£27.62	283X895 DOOR	£69.76	570X595 DOOR	£77.96	895X445 DOOR	£87.70
140X295 DRAWER	£20.84	283X995 DOOR	£74.76	645X595 DOOR	£90.30	895X495 DOOR	£94.20
140X395 DRAWER	£24.18	355X495 DOOR	£55.00	715X145 DOOR	£35.86	895X595 DOOR	£106.98
140X445 DRAWER	£26.66	355X595 DOOR	£60.60	715X255 DOOR	£63.26	980X595 DOOR	£115.24
140X495 DRAWER	£27.60	355X795 DOOR	£77.32	715X295 DOOR	£65.06	1245X295 DOOR	£87.24
140X595 DRAWER	£31.06	355X895 DOOR	£83.16	715X313 DOOR	£65.32	1245X395 DOOR	£103.06
140X795 DRAWER	£38.08	355X995 DOOR	£88.62	715X345 DOOR	£67.94	1245X495 DOOR	£120.90
140X895 DRAWER	£41.40	450X595 DOOR	£69.96	715X395 DOOR	£71.14	1245X595 DOOR	£138.30
140X995 DRAWER	£44.72	495X395 DOOR	£73.40	715X445 DOOR	£74.36	715 CURVE	£343.52
175X495 DRAWER	£32.18	495X595 DOOR	£73.40	715X495 DOOR	£77.70	895 CURVE	£390.92
175X595 DRAWER	£36.12	570X295 DOOR	£56.18	715X545 DOOR	£90.30	INT CURVE BASE	£343.52
283X495 DOOR	£50.06	570X395 DOOR	£61.78	715X595 DOOR	£90.30	INT CURVE WALL	£343.52
283X595 DOOR	£55.14	570X445 DOOR	£66.04	895X295 DOOR	£73.54	715X395 GLAZED	£111.50
283X795 DOOR	£64.90	570X495 DOOR	£69.00	895X395 DOOR	£83.26	715X495 GLAZED	£115.18
						1060X495 GLAZED	£140.00

MATCHING ACCESSORIES

CODE	DESCRIPTION	PRICE	CODE	DESCRIPTION	PRICE
ASH/COR	3M SHAKER CORNICE	£67.00	ASH/WPAN	965X350X19MM END PANEL	£91.00
ASH/CURCOR	EXTERNAL CURVED CORNICE	£94.00	ASH/PAN	965X650X19MM END PANEL	£166.00
ASH/INTCOR	INTERNAL CURVED CORNICE	£94.00	ASH/LAR	2440X650X19MM END PANEL	£265.00
ASH/OSCOR	OVERSIZED VENEER CORNICE	£113.00	ASH/ECOLAR	2440X650X19MM EN PANEL	£186.00
ASH/OSCURCOR	OVERSIZED EXTERNAL CURVED CORNICE	£172.00	ASH/150PAN	900X1500X19MM END PANEL	£213.00
ASHOSINTCOR	OVERSIZED INTERNAL CURVED CORNICIE	£172.00	ASH/TGPAN	965X650X19MM T+G END PAN	£179.00
ASH/MCOR	UNIVERSAL 3M CORNICE/PELMET	£67.00	ASH/TGLAR	2440X650X19MM T+G END PAN	£306.00
ASH/MCURCOR	UNIVERSAL EXTERNAL CURVED CORNICE	£57.00	ASH/TG150PAN	900X1500X19MM T+G END PAN	£306.00
ASH/MINTCOR	UNIVERSAL INTERNAL CURVED CORNICIE	£57.00	ASH/MANTLE	KEYSTONE OVER MANTLE KIT	£715.00
ASH/PEL	VENEER 3M PELMET	£66.30	ASH/PMANTLE	PANELLED OVER MANTEL	£415.00
ASH/CURPEL	EXTERNAL CURVED PELMET	£106.00	ASH/PLATE	PLATERACK LADDER RAIL	£133.00
ASH/INTPEL	INTERNAL CURVED PELMET	£106.00	ASH/WINE	WINE RACK BOTTLE RAIL FRONT & BACK	£114.00
ASH/PLIN	PLINTH 3M	£103.00	ASH/CORBLE	CORBLE	£69.00
ASH/CURPLIN	EXTERNAL CURVED PLINTH	£79.00	ASH/880PIL	880X100X100MM SOLID BLOCK PILASTER	£139.00
ASH/INTPLIN	INTERNAL CURVED PLINTH	£79.00	ASH/900PIL	900X50X50MM SOLID BLOCK PILASTER	£73.00
ASH/COL	2420X50X50MM VENEER 1/4 ROUND COLUMN	£169.00	ASH/PIL	2420X100X50MM VENEER BLOCK PILASTER	£123.00
ASH/100COL	2420X100X100MM VENEER 1/4 ROUND COLUMN	£267.00	ASH/QCAP	OVERSIZED 100MM CORNICE 1/4 CAP	£99.00
ASH/CCAP	100X100MM CORNICE 1/4 CAP	£94.00			

CORNICE

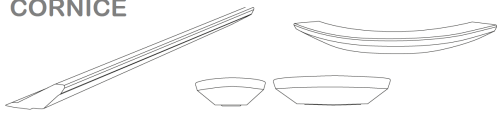

PELMET



PANELS

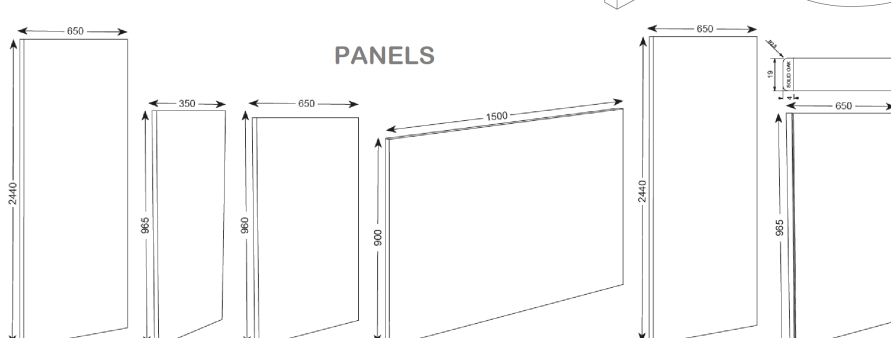

PILASTERS

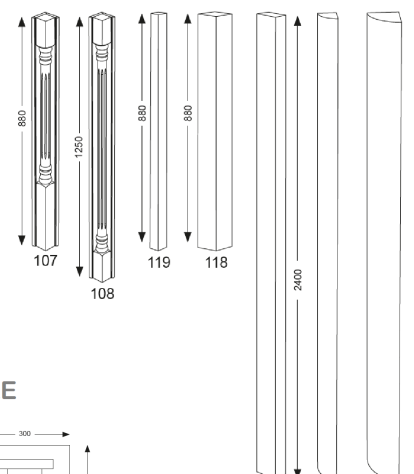

MANTLE

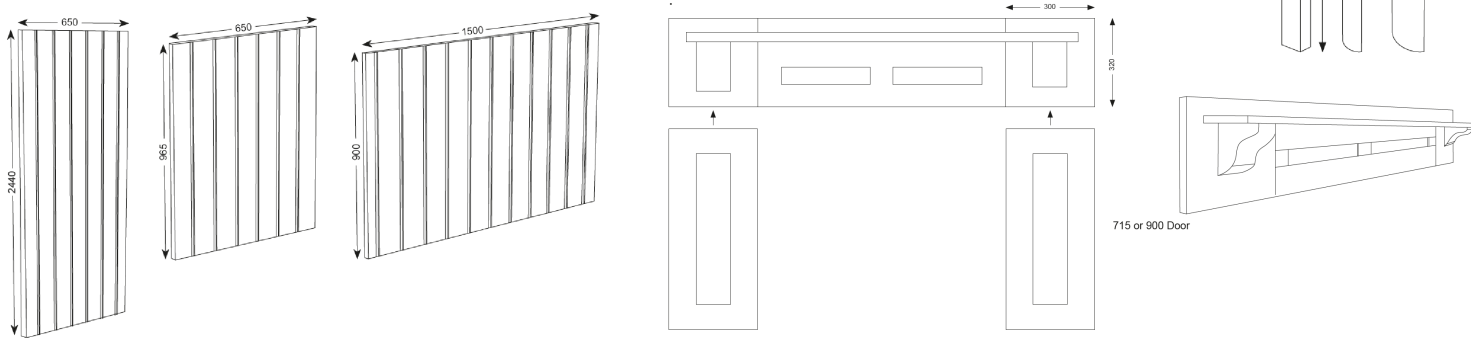

AIRO GLOSS (2 WEEK LEAD TIME)



SHOWROOM IMAGES



White

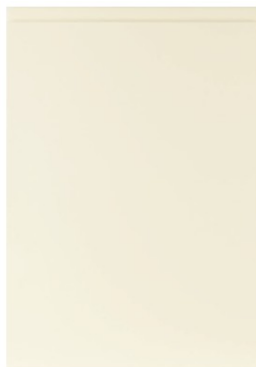

Alabaster

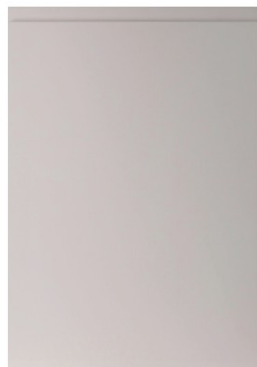

Cashmere



Light Grey



Dust Grey

AIRO GLOSS

SIZE	PRICE	SIZE	PRICE	SIZE	PRICE	SIZE	PRICE
110X595 BLANK	£14.86	283X895 DOOR	£35.98	450X595 DOOR	£37.34	715X595 DOOR	£53.26
140X295 DRAWER	£12.98	283X995 DOOR	£38.88	495X595 DOOR	£39.52	895X295 DOOR	£37.88
140X395 DRAWER	£13.48	283X1195 DOOR	£47.24	570X295 DOOR	£27.52	895X395 DOOR	£46.74
140X445 DRAWER	£14.32	355X495 DOOR	£28.40	570X395 DOOR	£31.66	895X445 DOOR	£51.52
140X495 DRAWER	£15.00	355X495 BLANK	£24.86	570X445 DOOR	£35.88	895X495 DOOR	£55.10
140X595 DRAWER	£16.10	355X595 DOOR	£31.98	570X495 DOOR	£36.84	895X595 DOOR	£60.70
140X795 DRAWER	£21.24	355X595 BLANK	£28.78	570X595 DOOR	£42.54	980X595 DOOR	£68.82
140X895 DRAWER	£22.76	355X795 DOOR	£38.90	715X145 DOOR	£21.82	1245X295 DOOR	£48.90
140X995 DRAWER	£24.14	355X795 BLANK	£36.56	715X255 DOOR	£29.20	1245X395 DOOR	£61.02
140X1195 DRAWER	£27.66	355X895 DOOR	£42.28	715X295 DOOR	£32.34	1245X495 DOOR	£69.62
175X495 DRAWER	£17.14	355X895 BLANK	£40.56	715X313 DOOR	£33.42	1245X595 DOOR	£84.12
175X595 DRAWER	£18.16	355X995 DOOR	£46.02	715X345 DOOR	£35.16	715 CURVE	£223.18
283X495 DOOR	£24.86	355X995 BLANK	£44.46	715X395 DOOR	£37.66	INT CURVE BASE	£229.26
283X595 DOOR	£27.32	355X1195 DOOR	£54.72	715X445 DOOR	£42.26	INT CURVE WALL	£223.18
283X795 DOOR	£33.26	355X1195 BLANK	£52.26	715X495 DOOR	£43.26	DOUBLE INT CURVE	£477.98

MATCHING ACCESSORIES

CODE	DESCRIPTION	PRICE	CODE	DESCRIPTION	PRICE
AIROG/MCOR	UNIVERSAL 3M CORNICE/PELMET	£37.51	AIROG/WPAN	772X377X19MM END PANEL	£37.86
AIROG/CURCOR	UNIVERSAL EXTERNAL CURVED CORNICE	£52.60	AIROG/TWPAN	952X377X19MM END PANEL	£46.15
AIROG/600INTCOR	600X600MM INT CURVED CORNICE	£52.60	AIROG/BPAN	900X650X19MM END PANEL	£63.29
AIROG/INTCOR	DOUBLE INTERNAL CURVED CORNICE	£98.85	AIROG/19LAR	2440X650X19MM END PANEL	£161.12
AIROG/PLIN	3M PLINTH	£50.07	AIROG/LAR	2440X650X22MM END PANEL	£183.07
AIROG/CURPLIN	EXTERNAL CURVED CORNICE	£61.04	AIROG/900PAN	900X2440X22MM END PANEL	£246.94
AIROG/900INTCOR	900X900MM INT CURVED PLINTH	£61.04	AIROG/PAN	900X1500X22MM END PANEL	£160.60
AIROG/INTPLIN	DOUBLE INTERNAL CURVED CORNICE	£93.02	AIROG/FLY	1245X395X22MM FLYSHELF	£61.03
AIROG/EXPOST	717X50X50MM EXTERNAL CORNER POST	£52.35	AIRO/COL	2400X100X100MM 1/4 ROUND CLOUMN	£185.26
AIROG/INTPOST	717X60X60MM INTERNAL CORNER POST	£52.35			

CORNICE

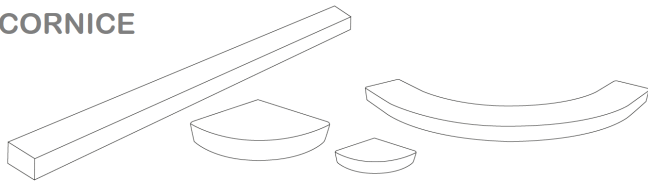

PLINTH

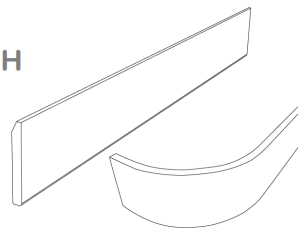

CORNER DOOR SETS

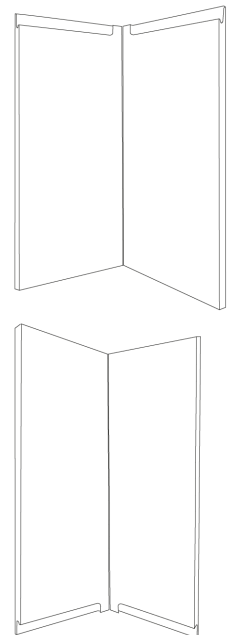

PANELS

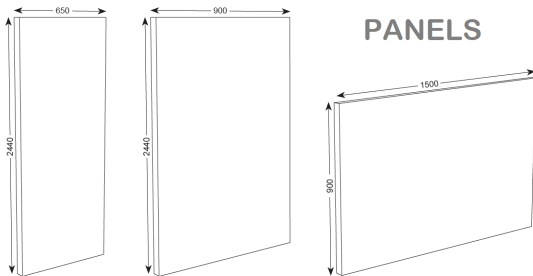

FEATURE & CORNER POSTS

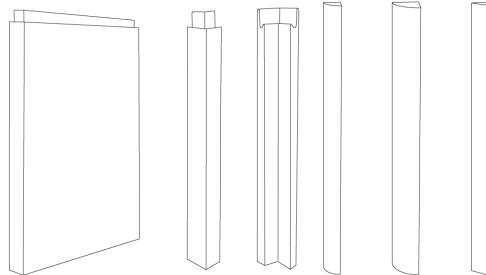

AIRO PAINTED TO ORDER (4 WEEK LEAD TIME)



PAINTED TO ORDER IN ANY GLOSS OR MATTE FINISH



Gloss Popular Colours



Materials *MDF Plus Painted*

Airo Gloss & Matte J profile door with integrated handle. This range is manufactured using MDF Plus, which is then painted to either the colours within the palette, or any bespoke colours to our customer's requirements at an additional cost.

AIRO PAINTED ANY

SIZE	PRICE	SIZE	PRICE	SIZE	PRICE	SIZE	PRICE
110X595 BLANK	£27.60	283X1195 DOOR	£88.48	570X445 DOOR	£78.30	980X595 DOOR	£148.26
140X295 DRAWER	£24.68	355X495 DOOR	£61.16	570X495 DOOR	£80.40	1245X295 DOOR	£104.62
140X395 DRAWER	£25.60	355X495 BLANK	£57.38	570X595 DOOR	£91.62	1245X395 DOOR	£130.60
140X445 DRAWER	£27.22	355X595 DOOR	£68.88	715X145 DOOR	£47.34	1245X495 DOOR	£149.00
140X495 DRAWER	£28.08	355X595 BLANK	£64.40	715X255 DOOR	£64.34	1245X595 DOOR	£178.84
140X595 DRAWER	£30.84	355X795 DOOR	£83.80	715X295 DOOR	£70.10	1965X295 DOOR	£229.33
140X795 DRAWER	£40.64	355X795 BLANK	£78.76	715X313 DOOR	£73.42	1965X395 DOOR	£277.90
140X895 DRAWER	£43.18	355X895 DOOR	£91.66	715X345 DOOR	£80.56	1965X495 DOOR	£326.60
140X995 DRAWER	£45.88	355X895 BLANK	£85.68	715X395 DOOR	£84.64	1965X595 DOOR	£375.32
140X1195 DRAWER	£52.56	355X995 DOOR	£99.14	715X445 DOOR	£91.04	715 CURVE	£388.62
175X495 DRAWER	£32.58	355X995 BLANK	£92.64	715X495 DOOR	£91.44	895 CURVE	£446.92
175X595 DRAWER	£34.50	355X1195 DOOR	£115.56	715X595 DOOR	£112.50	INT CURVE BASE	£388.62
283X495 DOOR	£46.20	355X1195 BLANK	£99.30	895X295 DOOR	£81.60	INT CURVE WALL	£401.54
283X595 DOOR	£51.56	450X595 DOOR	£80.94	895X395 DOOR	£100.70	DOUBLE INT CURVE	£908.46
283X795 DOOR	£62.26	495X595 DOOR	£86.80	895X445 DOOR	£109.54	715X495 GLAZED	£172.34
283X895 DOOR	£67.38	570X295 DOOR	£60.42	895X495 DOOR	£119.44		
283X995 DOOR	£72.80	570X395 DOOR	£69.08	895X595 DOOR	£130.78		

MATCHING ACCESSORIES

CODE	DESCRIPTION	PRICE	CODE	DESCRIPTION	PRICE
AIROGP/COR	UNIVERSAL 3M CORNICE/PELMET	£86.00	AIROGP/LAR	2440X650X22MM END PANEL	£471.00
AIROGP/CURCOR	UNIVERSAL EXTERNAL CURVED CORNICE	£97.00	AIROGP/PAN	900X1500X22MM END PANEL	£413.00
AIROGP/600INTCOR	600X600MM INT CURVED CORNICE	£97.00	AIROGP/BBAR	2440X900X22MM END PANEL	£573.00
AIROGP/INTCOR	DOUBLE INTERNAL CURVED CORNICE	£188.00	AIROGP/EXPOST	717X50X50MM EXTERNAL CORNER POST	£74.00
AIROGP/PLIN	3M PLINTH	£107.00	AIROGP/INTPOST	717X60X60MM INTERNAL CORNER POST	£74.00
AIROGP/CURPLIN	EXTERNAL CURVED PLINTH	£112.00	AIROGP/COL	2400X100X100MM 1/4 ROUND COLUMN	£316.40
AIROGP/900INTPLIN	900X900MM INT CURVED PLINTH	£98.00	AIROGP/COL2	2400X50X50MM 1/4 ROUND COLUMN	£198.14
AIROGP/INTPLIN	DOUBLE INTERNAL CURVED CORNICE	£171.00	AIROGP/CAP	1/4 ROUND CAP FOR 100MM COLUMN	£52.02
AIRO/PIL	2400X50X100MM BLOCK PILASTER	£168.00	AIROGP/CAP2	1/4 ROUND CAP FOR 50MM	£46.82

CORNICE

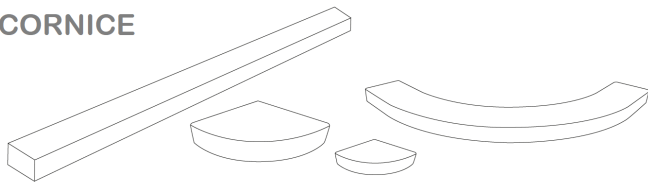

PLINTH

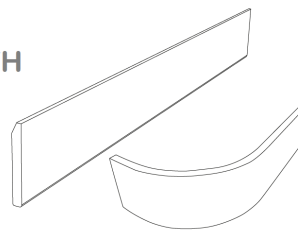

CORNER DOOR SETS

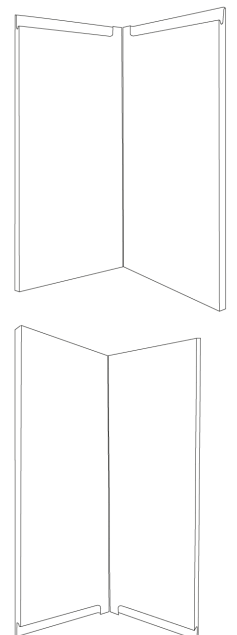

PANELS

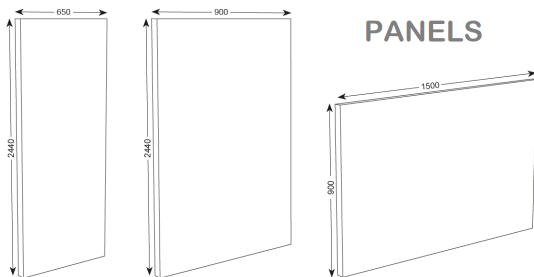

FEATURE & CORNER POSTS

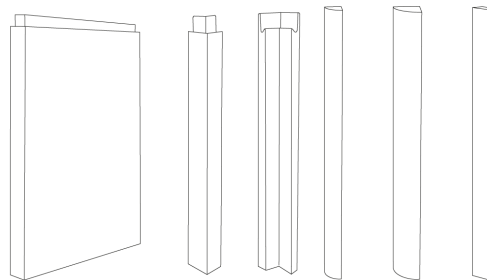

CABINET SPECIFICATION

Our BESPOKE cabinets are made to order in your choice of 30 cabinet colours. You can choose your cabinet colour to either match or contrast against your chosen door style. Cabinets can be made to non-standard configurations to suit your requirements. All our cabinets come pre assembled, with the exception of L—shape corner base units and large wardrobes, as they will not fit through doorways.

All our cabinets are supplied fully assembled, and are made using EGGER furniture board.



Our cabinets are hand made in our factory in Sheffield. All our cabinets are bespoke and made to order in your choice of 30 colours, to either match, or contrast, your chosen door style.

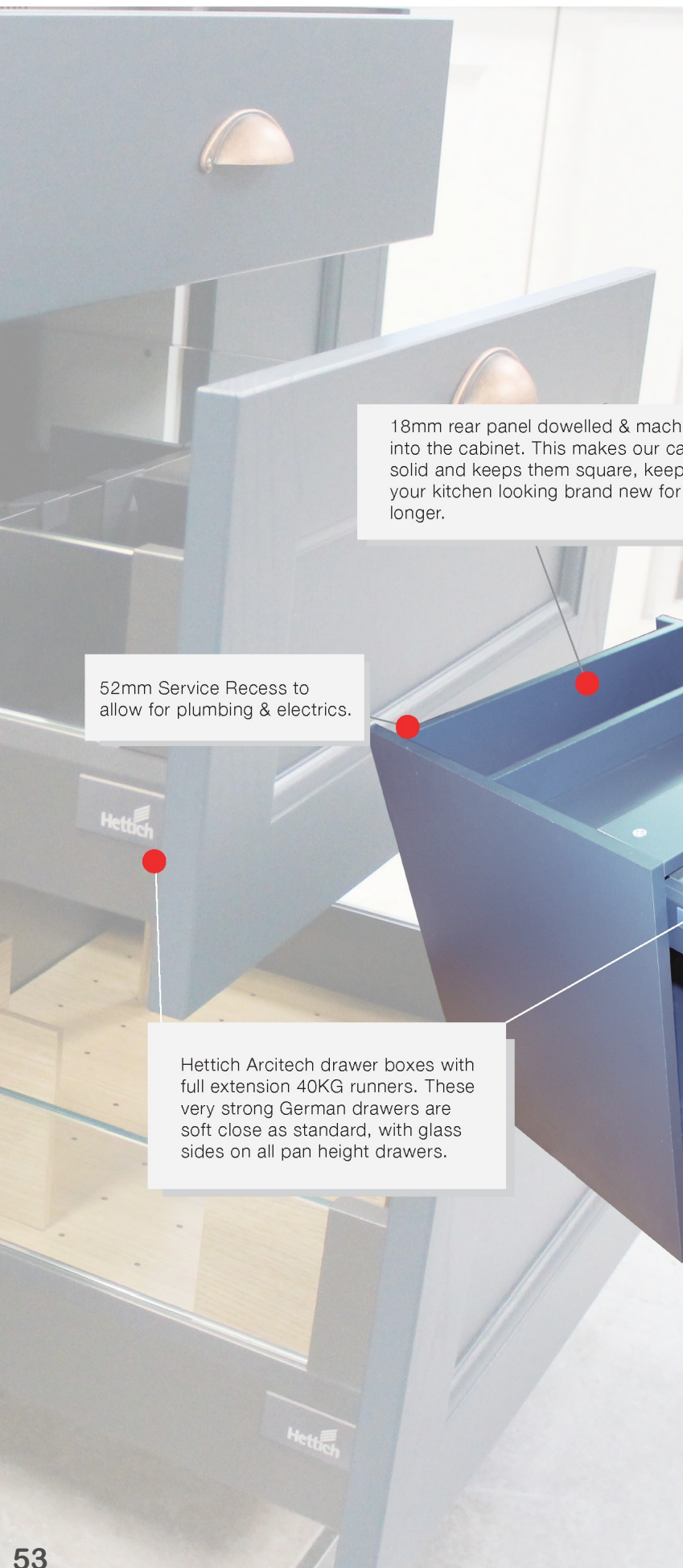

18mm rear panel dowelled & machined into the cabinet. This makes our cabinets solid and keeps them square, keeping your kitchen looking brand new for much longer.

52mm Service Recess to allow for plumbing & electrics.

Hettich Arcitech drawer boxes with full extension 40KG runners. These very strong German drawers are soft close as standard, with glass sides on all pan height drawers.

Durable 1mm ABS edges colour matched to your chosen cabinet colour.



All our cabinets come complete with german HETTICH quick fit, clip on hinges, with soft close as standard.

CABINET COLOURS

All our made to order cabinets can be manufactured using any of the 30 colours below. You can choose the colour best matches, or contrasts against any of our door ranges.

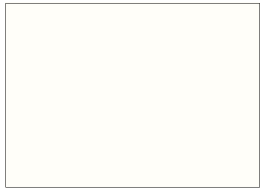

W980 ST2 (WH)
PLATINUM WHITE



U104 ST9 (WH)
ALABASTER
WHITE



U702 ST9 (WG)
CASHMERE GREY



U727 ST9 (WG)
STONE GREY



U201 ST9 (WG)
PEBBLE GREY

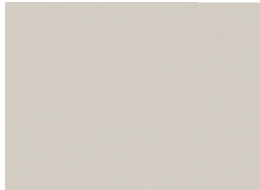

U708 ST9 (WG)
LIGHT GREY



U763 ST9 (WG)
PEARL GREY



U732 ST9 (WG)
DUST GREY



U960 ST9 (WG)
ONYX GREY



U780 ST9 (WG)
MONUMENT
GREY



U961 ST9 (WG)
GRAPHITE GREY



U507 ST9 (WG)
SMOKE BLUE



U599 ST9 (WG)
INDIGO BLUE



U636 ST9 (WG)
FJORD GREEN



U717 ST9 (WG)
DAKAR GREY

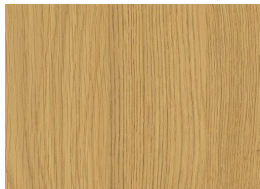

H3368 ST9 (WG)
NATURAL
LANCASTER OAK



H3303 ST10 (WG)
NATURAL
HAMILTON OAK

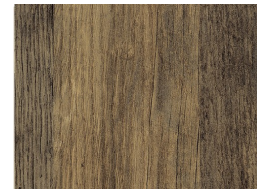

H1330 ST10 (WG)
VINTAGE
SANTA FE OAK

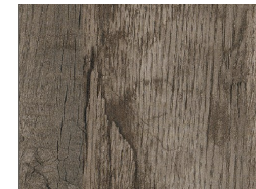

H1331 ST19 (WG)
GREY SANTA FE
OAK

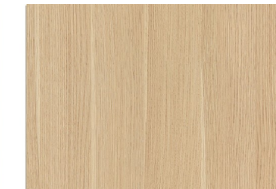

H3349 ST19 (WG)
KAISENBERG
OAK



H3190 ST19 (WG)
ANTHRACITE
FINELINE METALLIC

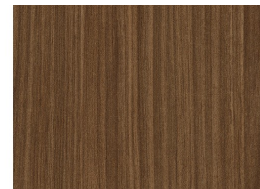

H1714 ST19 (WG)
LINCOLN
WALNUT

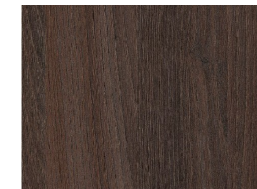

H1253 ST19 (WG)
TRUFFLE BROWN
BRANSON ROBINA

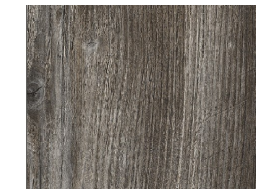

H1486 ST38 (WG2)
PASADENA PINE

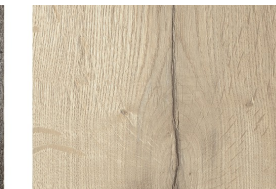

H1176 ST37 (WG2)
WHITE HALIFAX
OAK

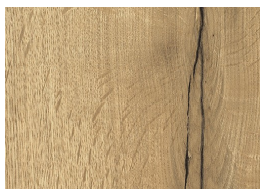

H1180 ST37 (WG2)
NATURAL
HALIFAX OAK

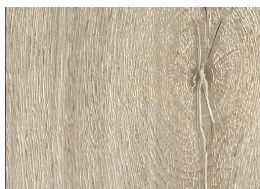

H1136 ST37 (WG2)
SANG GREY
GLAZED HALIFAX
OAK

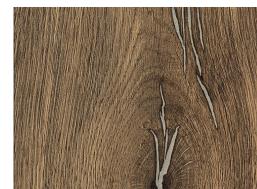

H1376 ST37 (WG2)
PEWTER HALIFAX
OAK

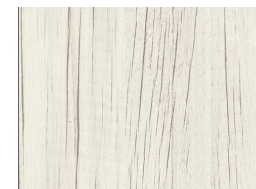

H1122 ST22 (WG2)
WHITWOOD

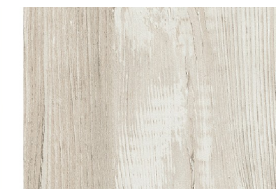

H1401 ST22 (WG2)
CASCINA PINE

Single Base Cabinets

All single base units supplied with 1 x 400mm deep adjustable shelf, 4 x shelf supports, 4 x 150mm adjustable legs and 2 x Hettich soft close hinges with quick release plates. Hinge holes are drilled to both sides. All single base units have a 52mm service recess and 18mm solid back panels.

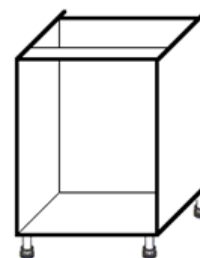

DESCRIPTION			CODE	WH	WG	WG2
150mm HI LINE BASE UNIT			150BFH	£120.68	£138.32	£165.08
Width:- 150mm	Depth:- 570mm	Height:- 720mm	Requires 1 x 715 x 145 Door			
300mm HI LINE BASE UNIT			300BFH	£123.56	£142.84	£172.16
Width:- 300mm	Depth:- 570mm	Height:- 720mm	Requires 1 x 715 x 295 Door			
350mm HI LINE BASE UNIT			350BFH	£125.64	£146.16	£177.30
Width:- 350mm	Depth:- 570mm	Height:- 720mm	Requires 1 x 715 x 345 Door			
400mm HI LINE BASE UNIT			400BFH	£127.96	£149.84	£183.08
Width:- 400mm	Depth:- 570mm	Height:- 720mm	Requires 1 x 715 x 395 Door			
450mm HI LINE BASE UNIT			450BFH	£130.32	£153.56	£188.87
Width:- 450mm	Depth:- 570mm	Height:- 720mm	Requires 1 x 715 x 445 Door			
500mm HI LINE BASE UNIT			500BFH	£132.40	£156.84	£194.00
Width:- 500mm	Depth:- 570mm	Height:- 720mm	Requires 1 x 715 x 495 Door			
550mm HI LINE BASE UNIT			550BFH	£134.72	£160.56	£199.80
Width:- 550mm	Depth:- 570mm	Height:- 720mm	Requires 1 x 715 x 555 Door			
600mm HI LINE BASE UNIT			600BFH	£136.80	£163.84	£204.94
Width:- 600mm	Depth:- 570mm	Height:- 720mm	Requires 1 x 715 x 595 Door			
600mm BELFAST BASE UNIT 460H			600BSB1	£131.36	£155.20	£191.44
Width:- 600mm	Depth:- 570mm	Height:- 460mm	Requires 1 x 450 x 595 Door			

Double Base Cabinets

All double base units supplied with 1 x 400mm deep adjustable shelf, 4 x shelf supports, 4 x 150mm adjustable legs and 4 x Hettich soft close hinges with quick release plates. Centre posts 36mm wide x 60mm deep are fitted to all double base units. Hinge holes are drilled to both sides. All single base units have a 52mm service recess and 18mm solid back panels. Double base units 1000mm wide and over are supplied with 5 x cabinet legs

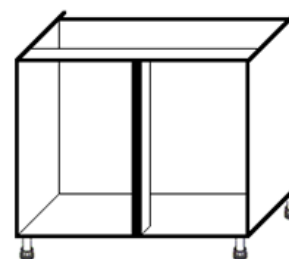

DESCRIPTION			CODE	WH	WG	WG2
700 HI LINE BASE UNIT			700BFH	£172.56	£204.32	£252.55
Width:- 700mm	Depth:- 570mm	Height:- 720mm	Requires 2 x 715 x 345 Doors			
800 HI LINE BASE UNIT			800BFH	£177.24	£211.72	£264.12
Width:- 800mm	Depth:- 570mm	Height:- 720mm	Requires 2 x 715 x 395 Doors			
900 HI LINE BASE UNIT			900BFH	£181.64	£218.72	£275.04
Width:- 900mm	Depth:- 570mm	Height:- 720mm	Requires 2 x 715 x 445 Doors			
1000 HI LINE BASE UNIT			100BFH	£186.08	£225.72	£285.97
Width: 1000mm	Depth:- 570mm	Height:- 720mm	Requires 2 x 715 x 495 Doors			
1100 HI LINE BASE UNIT			110BFH	£190.48	£232.72	£296.90
Width: 1100mm	Depth:- 570mm	Height:- 720mm	Requires 2 x 715 x 545 Doors			
1200 HI LINE BASE UNIT			120BFH	£195.48	£240.32	£308.39
Width: 1200mm	Depth:- 570mm	Height:- 720mm	Requires 2 x 715 x 595 Doors			

Single Drawer-line Base Cabinets

All single drawer line base units supplied with 1 x 400mm deep adjustable shelf. 4 x shelf supports, 4 x 150mm adjustable legs and 2 x Hettich soft close hinges with quick release plates. Hinge holes are drilled to both sides. All single base units have a 52mm service recess and 18mm solid back panels. 1 x 450mm deep, Hettich ArciTech soft close drawer, in anthracite, are supplied pre installed into the cabinet.

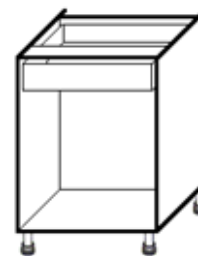

DESCRIPTION			CODE	WH	WG	WG2
300 DRAWER LINE BASE UNIT			300BDL/TAN	£237.56	£256.84	£286.16
Width:- 300mm	Depth:- 570mm	Height:- 720mm	Requires 1 x 140 x 295 Drawer & 1 x 570 x 295 Door			
350 DRAWER LINE BASE UNIT			350BDL/TAN	£239.56	£260.16	£291.28
Width:- 350mm	Depth:- 570mm	Height:- 720mm	Requires 1 x 140 x 345 Drawer & 1 x 570 x 345 Door			
400 DRAWER LINE BASE UNIT			400BDL/TAN	£241.96	£263.84	£297.08
Width:- 400mm	Depth:- 570mm	Height:- 720mm	Requires 1 x 140 x 395 Drawer & 1 x 570 x 395 Door			
450 DRAWER LINE BASE UNIT			450BDL/TAN	£244.32	£267.56	£302.88
Width:- 450mm	Depth:- 570mm	Height:- 720mm	Requires 1 x 140 x 445 Drawer & 1 x 570 x 445 Door			
500 DRAWER LINE BASE UNIT			500BDL/TAN	£246.40	£270.84	£308.00
Width:- 500mm	Depth:- 570mm	Height:- 720mm	Requires 1 x 140 x 495 Drawer & 1 x 570 x 495 Door			
600 DRAWER LINE BASE UNIT			600BDL/TAN	£250.80	£277.84	£318.92
Width:- 600mm	Depth:- 570mm	Height:- 720mm	Requires 1 x 140 x 595 Drawer & 1 x 570 x 595 Door			

Double Drawer-line Base Cabinets

All double drawer line base units supplied with 1 x 400mm deep adjustable shelf, 4 x shelf supports, 4 x 150mm adjustable legs and 4 x Hettich soft close hinges with quick release plates. Hinge holes are drilled to both sides. All units have a 52mm service recess and 18mm solid back panels. 2 x 450mm deep, Hettich ArciTech soft close drawer, in anthracite, are supplied pre installed into the cabinet. Centre posts 36mm wide x 60mm deep are fitted to all double base units. Units 1000mm wide and over are supplied with 5 x cabinet legs.

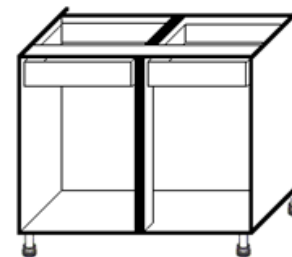

DESCRIPTION			CODE	WH	WG	WG2
800 DRAWER LINE BASE UNIT			800BDL/TAN	£410.16	£447.56	£504.32
Width:- 800mm	Depth:- 570mm	Height:- 720mm	Requires 2 x 140 x 395 Drawer & 2 x 570 x 395 Doors			
900 DRAWER LINE BASE UNIT			900BDL/TAN	£414.84	£454.96	£515.92
Width:- 900mm	Depth:- 570mm	Height:- 720mm	Requires 2 x 140 x 445 Drawer & 2 x 570 x 445 Doors			
1000 DRAWER LINE BASE UNIT			100BDL/TAN	£419.80	£462.80	£524.12
Width: 1000mm	Depth:- 570mm	Height:- 720mm	Requires 2 x 140 x 495 Drawer & 2 x 570 x 495 Doors			
1200 DRAWER LINE BASE UNIT			120BDL/TAN	£425.72	£474.20	£547.80
Width: 1100mm	Depth:- 570mm	Height:- 720mm	Requires 2 x 140 x 595 Drawer & 2 x 570 x 595 Doors			

Curved Base Cabinet

Curved Base units can be used with a 260mm x 300mm deep base. Curved base & 260 base units have no service recess & a solid 18mm rear panels. The curved base unit has a fixed shelf to the centre, supplied with 4 x 150mm adjustable legs and 2 x Hettich soft close hinges with quick release plates. A Curved base unit will need a curved plinth ordering from the matching accessories of your chosen door range.

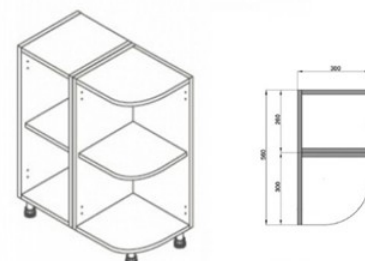

DESCRIPTION			CODE	WH	WG	WG2
260mm HI LINE BASE UNIT (300DEEP FOR CURVED UNIT)			260BFH	£109.52	£120.60	£137.44
Width:- 260mm	Depth:- 300mm	Height:- 720mm	Requires 1 x 715 x 255 Door			
300mm CURVED BASE UNIT			CURV/BASE	£129.76	£141.00	£158.09
Width:- 300mm	Depth:- 300mm	Height:- 720mm	Requires 1 x 715 x 300 Curved Door (external)			

Angled Base Cabinet

Angled base units are supplied with 1 x adjustable shelf, 4 x shelf supports, 4 x 150mm adjustable legs and 2 x Hettich soft close 45 degree hinges with quick release plates. Angled base units are designed to be fitted 15mm from the front of adjoining cabinets so the doors look flush when fitted. Angled base units have a 52mm service recess and 18mm solid back panels

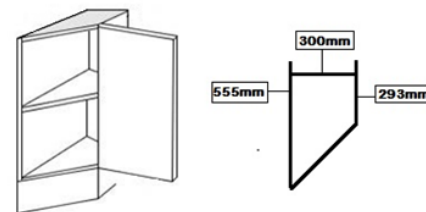

DESCRIPTION			CODE	WH	WG	WG2
300mm ANGLED HI LINE BASE UNIT (LH & RH)			300AFH	£125.64	£143.56	£170.81
Width:- 300mm	Depth:- 555mm	Height:- 720mm	Requires 1 x 715 x 395 Door			

5 Drawer Base Cabinet

5 Drawer packs cannot be used with J-Profile doors

All 5 drawer packs are supplied with 5 standard height, Hettich ArchiTech soft close drawer boxes in anthracite, pre installed into the units. All 5 drawer units have a 52mm service recess and 18mm solid back panels. This cabinet is also supplied with 4 x 150mm cabinet legs.

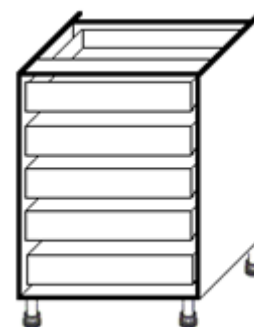

DESCRIPTION			CODE	WH	WG	WG2
300 5 DRAWER PACK UNIT			3005DP/TAN	£614.36	£632.00	£658.76
Width: - 300mm	Depth:- 570mm	Height:- 720mm	Requires 5 x 140 x 295			
400 5 DRAWER PACK UNIT			4005DP/TAN	£618.00	£637.76	£667.76
Width: - 400mm	Depth:- 570mm	Height:- 720mm	Requires 5 x 140 x 395			
500 5 DRAWER PACK UNIT			5005DP/TAN	£621.40	£643.12	£676.12
Width: - 500mm	Depth:- 570mm	Height:- 720mm	Requires 5 x 140 x 495			
600 5 DRAWER PACK UNIT			6005DP/TAN	£624.76	£648.48	£684.48
Width: - 600mm	Depth:- 570mm	Height:- 720mm	Requires 5 x 140 x 595			

4 Drawer Base Cabinet

All 4 drawer packs are supplied with 4 standard height, Hettich ArchiTech soft close drawer boxes in anthracite, pre installed into the units. All 4 drawer units have a 52mm service recess and 18mm solid back panels. This cabinet is also supplied with 4 x 150mm cabinet legs.

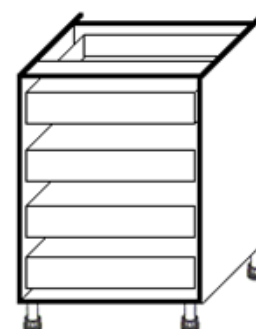

DESCRIPTION			CODE	WH	WG	WG2
400 4 DRAWER PACK UNIT			4004DP/TAN	£544.00	£563.76	£593.76
Width: - 400mm	Depth:- 570mm	Height:- 720mm	Requires 4 x 175 x 395			
500 4 DRAWER PACK UNIT			5004DP/TAN	£547.40	£569.12	£602.12
Width: - 500mm	Depth:- 570mm	Height:- 720mm	Requires 4 x 175 x 495			
600 4 DRAWER PACK UNIT			6004DP/TAN	£550.76	£574.48	£610.48
Width: - 600mm	Depth:- 570mm	Height:- 720mm	Requires 4 x 175 x 595			

3 Drawer Base Cabinet

All 3 drawer packs are supplied with 1 x standard height, & 2 x pan height Hettich ArchiTech soft close drawer boxes in anthracite, pre installed into the units. All 4 drawer units have a 52mm service recess and 18mm solid back panels. This cabinet is also supplied with 4 x 150mm cabinet legs.

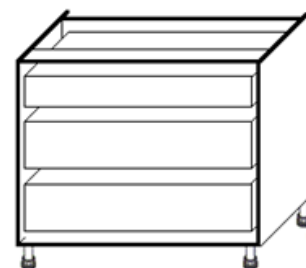

DESCRIPTION			CODE	WH	WG	WG2
500 3 DRAWER PACK UNIT			5003DP/TAN	£557.40	£579.12	£612.12
WIDTH: - 500MM	DEPTH:- 570MM	HEIGHT:- 720MM	REQUIRES 1 x 140 x 495 & 2 x 283 x 495			
600 3 DRAWER PACK UNIT			6003DP/TAN	£560.76	£584.48	£540.48
WIDTH: - 600MM	DEPTH:- 570MM	HEIGHT:- 720MM	REQUIRES 1 x 140 x 595 & 2 x 283 x 595			
800 3 DRAWER PACK UNIT			8003DP/TAN	£567.52	£595.20	£637.20
WIDTH: - 800MM	DEPTH:- 570MM	HEIGHT:- 720MM	REQUIRES 1 x 140 x 795 & 2 x 283 x 795			
900 3 DRAWER PACK UNIT			9003DP/TAN	£570.93	£600.56	£645.56
WIDTH: - 900MM	DEPTH:- 570MM	HEIGHT:- 720MM	REQUIRES 1 x 140 x 895 & 2 x 283 x 895			
1000 3 DRAWER PACK UNIT			1003DP/TAN	£574.56	£608.00	£654.56
WIDTH: 1000MM	DEPTH:- 570MM	HEIGHT:- 720MM	REQUIRES 1 x 140 x 995 & 2 x 283 x 995			

2 Drawer Base Cabinet

All 2 drawer packs are supplied with 2 x pan height Hettich ArchiTech soft close drawer boxes in anthracite, pre installed into the units. 2 drawer packs are also available with an internal cutlery drawer in the top. Internal drawers are accessed when the top pan drawer is open and is supplied with a frontal pre installed onto the unit. All 4 drawer units have a 52mm service recess and 18mm solid back panels. This cabinet is also supplied with 4 x 150mm cabinet legs.

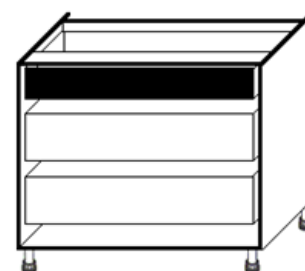
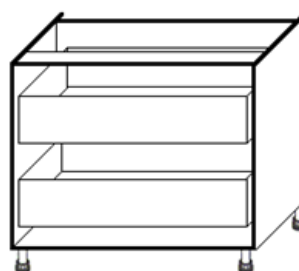

With Internal Drawer

DESCRIPTION			CODE	WH	WG	WG2
500 2 DRAWER PACK UNIT			5002DP/TAN	£483.40	£505.12	£538.12
Width: - 500mm	Depth:- 570mm	Height:- 720mm	Requires 2 x 355 x 495			
500 2 DRAWER UNIT WITH INTERNAL DRAWER			5002DP/INT	£587.28	£609.00	£642.00
Width: - 500mm	Depth:- 570mm	Height:- 720mm	Requires 2 x 355 x 495			
600 2 DRAWER PACK UNIT			6002DP/TAN	£486.76	£510.48	£546.48
Width: - 600mm	Depth:- 570mm	Height:- 720mm	Requires 2 x 355 x 595			
600 2 DRAWER UNIT WITH INTERNAL DRAWER			6002DP/INT	£592.80	£616.52	£638.52
Width: - 600mm	Depth:- 570mm	Height:- 720mm	Requires 2 x 355 x 595			
800 2 DRAWER PACK UNIT			8002DP/TAN	£493.52	£521.20	£563.20
Width:- 800mm	Depth:- 570mm	Height:- 720mm	Requires 2 x 355 x 795			
800 2 DRAWER UNIT WITH INTERNAL DRAWER			8002DP/INT	£612.36	£640.04	£682.04
Width: - 800mm	Depth:- 570mm	Height:- 720mm	Requires 2 x 355 x 795			
900 2 DRAWER PACK UNIT			9002DP/TAN	£496.92	£526.56	£571.56
Width:- 900mm	Depth:- 570mm	Height:- 720mm	Requires 2 x 355 x 895			
900 2 DRAWER UNIT WITH INTERNAL DRAWER			9002DP/INT	£617.88	£647.52	£692.40
Width:- 900mm	Depth:- 570mm	Height:- 720mm	Requires 2 x 355 x 895			
1000 2 DRAWER PACK UNIT			1002DP/TAN	£500.56	£532.32	£580.56
Width: 1000mm	Depth:- 570mm	Height:- 720mm	Requires 2 x 355 x 995			
1000 2 DRAWER UNIT WITH INTERNAL DRAWER			1002DP/INT	£623.68	£655.44	£703.68
Width: 1000mm	Depth:- 570mm	Height:- 720mm	Requires 2 x 355 x 995			

Pull Out Bin Base Cabinet

All our pull out bin units are supplied with a Hettich ArchiTech soft close bin system, with the bins pre-installed into the unit. All pull out bin units have a 52mm service recess and 18mm solid back panels. Pull out bin units are supplied with 4 x 150mm adjustable legs.

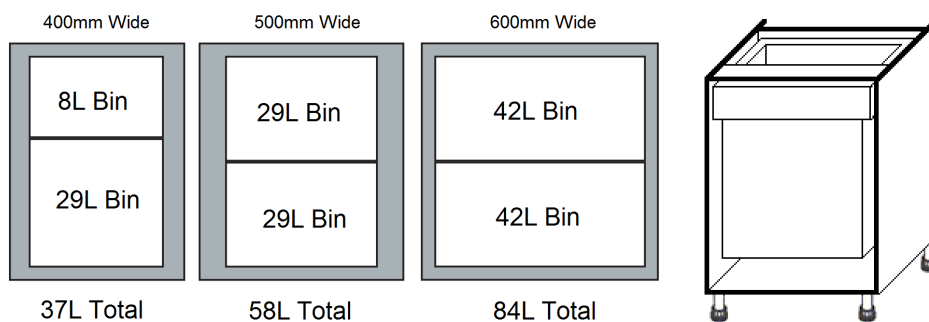

DESCRIPTION			CODE	WH	WG	WG2
400 PULL OUT BIN UNIT			400PPB	£573.96	£593.72	£623.72
Width: - 400mm	Depth:- 570mm	Height:- 720mm	Requires 1 x 715 x 395			
500 PULL OUT BIN UNIT			500PPB	£623.76	£645.64	£678.88
Width: - 500mm	Depth:- 570mm	Height:- 720mm	Requires 1 x 715 x 495			
600 PULL OUT BIN UNIT			600PPB	£732.72	£756.56	£792.80
Width: - 600mm	Depth:- 570mm	Height:- 720mm	Requires 1 x 715 x 595			

Base Cabinets To Suit Pull Out Wirework

All base pull out units are supplied without wire work which must be ordered separately (please see page 103 For the various options). The pull out mechanism MUST be fitted into the unit by your installer prior to installing the cabinet into the kitchen. To install the pull out we recommend removing one of the side panels. All pull out base units have a 32mm service recess and 18mm solid back panels. These cabinets are supplied with no drill holes to the inside & are supplied with 4 x 150mm adjustable legs only.

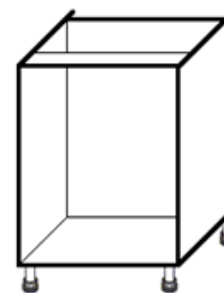

DESCRIPTION			CODE	WH	WG	WG2
150 BASE TO SUIT 150mm PULL OUT UNIT			150POB	£112.36	£130.00	£146.76
Width:- 150mm	Depth:- 570mm	Height:- 720mm	Requires 1 x 715 x 145 & 150mm Pull Out System			
300 BASE TO SUIT 300mm PULL OUT UNIT			300POB	£115.24	£134.52	£163.84
Width:- 300mm	Depth:- 570mm	Height:- 720mm	Requires 1 x 715 x 295 & 300mm Pull Out System			

L-Shaped Corner Base Units (flat packed)

All 905 x 905 corner units are supplied flat pack for easy delivery. Hinge holes are drilled to both sides. All 905 corners have a 52mm service recess & solid 18mm rear panels. This cabinet is supplied with 1 x 400mm deep adjustable shelf, 6 x shelf supports, 6 x 150mm adjustable legs and 2 x Hettich 165 degree soft close hinges with quick release plates and 2 x bi fold hinges with face fixing screw on plates. When ordered with a 22mm thick J-Profile door we recommend a 910mm x 910mm cabinet, supplied with 4 x 165 degree hinges and 4 quick release hinge plates. Please ensure you fit the shelf in the unit before fitting your worktops.

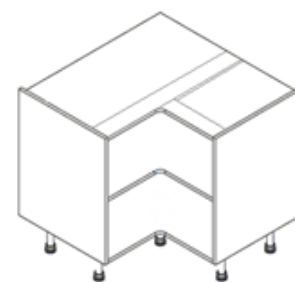

DESCRIPTION			CODE	WH	WG	WG2
905X905 CORNER UNIT (FLAT PACK)			905FHC	£300.48	£353.36	£433.68
Width:- 905mm	Depth:- 905mm	Height:- 720mm	Requires 2 x 715 x 313			
910X910 CORNER UNIT (FLAT PACK)			910FHC	£328.48	£385.36	£465.68
Width:- 905mm	Depth:- 905mm	Height:- 720mm	Requires 2 x 715 x 313			

All 910 x 910 Internal Curved Corner Unit are supplied flat pack for easy delivery. Hinge holes are drilled to both sides. This cabinet is supplied with 1 x 400mm deep adjustable shelf, 6 x shelf supports, 6 x 150mm adjustable legs and 4 x Hettich 165 degree soft close hinges with quick release plates. All curved corners have a 52mm service recess & solid 18mm rear panels. Please ensure you fit the shelf in the unit before fitting your worktops. **An internal curved corner base unit will require an internal curved plinth ordering from the matching accessories of your chosen door range.**

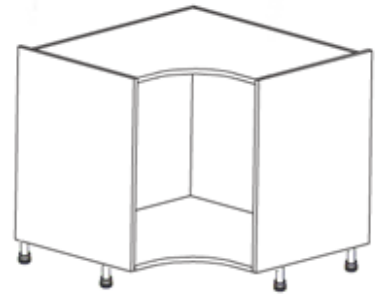

DESCRIPTION			CODE	WH	WG	WG2
INTERNAL CURVED BASE UNIT			INTBASE	£304.24	£366.08	£460.00
Width:- 910mm	Depth:- 910mm	Height:- 720mm	Requires Internal Curve Base Door Set			

Hi Line Corner Base Units

All base corner units supplied with 1 x 400mm deep adjustable shelf, 4 x shelf supports, 4 x 150mm adjustable legs and 2 x Hettich soft close hinges with quick release plates. Centre posts 36mm wide x 60mm deep are fitted to all corner base units. Hinge holes are drilled to both sides. All corner base units have a 52mm service recess and 18mm solid back panels. Units 1000mm wide and over are supplied with 5 x cabinet legs. A blanking panel is supplied loose with each cabinet. **The corner unit illustrated is a LEFT HAND UNIT.** Kidney corner solutions can be fitted to these cabinets, please see page 104

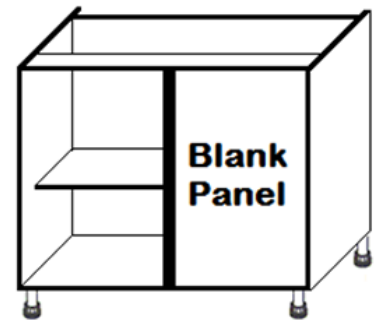

DESCRIPTION			CODE	WH	WG	WG2
800 HI LINE CORNER UNIT (400 DOOR)			800FHC	£200.48	£241.36	£303.43
Width:- 800mm	Depth:- 570mm	Height:- 720mm	Requires 1 x 715 x 395 Door			
900 HI LINE CORNER UNIT (450 DOOR)			900FHC	£205.16	£248.76	£315.00
Width:- 900mm	Depth:- 570mm	Height:- 720mm	Requires 1 x 715 x 445 Door			
1000 HI LINE CORNER UNIT (500 DOOR)			100FHC	£209.56	£255.76	£325.92
Width: 1000mm	Depth:- 570mm	Height:- 720mm	Requires 1 x 715 x 495 Door			
1100 HI LINE CORNER UNIT (550 DOOR)			110FHC	£214.00	£262.76	£336.84
Width: 1100mm	Depth:- 570mm	Height:- 720mm	Requires 1 x 715 x 545 Door			
1100 HI LINE CORNER UNIT RIGHT HAND (600 DOOR)			110FHC/RH	£214.00	£262.76	£336.84
Width: 1100mm	Depth:- 570mm	Height:- 720mm	Requires 1 x 715 x 595 Door			
1100 HI LINE CORNER UNIT LEFT HAND (600 DOOR)			110FHC/LH	£214.00	£262.76	£336.84
Width: 1100mm	Depth:- 570mm	Height:- 720mm	Requires 1 x 715 x 595 Door			

Hi Line Corner Base Units To Suit Magic Corners

Hi line corners to suit magic corner wirework are supplied with the door facia undrilled for hinges, the cabinet is also supplied without hinges or a shelf. **Magic corner systems are not supplied with the cabinet and must be ordered separately, see page 104 For available options.**

DESCRIPTION			STOCK CODE	WH	WG	WG2
900 HI LINE TO SUIT MAGIC CORNER (450 DOOR)			900FHMC	£198.84	£240.44	£306.68
Width:- 900mm	Depth:- 570mm	Height:- 720mm	Requires 1 x 715 x 445 Door			
1000 HI LINE TO SUIT MAGIC CORNER (500 Door)			100FHMC	£201.24	£247.44	£317.60
Width: 1000mm	Depth:- 570mm	Height:- 720mm	Requires 1 x 715 x 495 Door			
1100 HI LINE TO SUIT MAGIC CORNER (550DOOR)			110FHMC/550	£205.68	£254.44	£328.52
Width: 1100mm	Depth:- 570mm	Height:- 720mm	Requires 1 x 715 x 545 Door			
1100 HI LINE TO SUITL/H MAGIC CORNER (600DOOR)			110FHMC/600L	£205.68	£254.44	£328.52
Width: 1100mm	Depth:- 570mm	Height:- 720mm	Requires 1 x 715 x 595 Door			
1100 HI LINE TO SUIT R/H MAGIC CORNER (600DOOR)			110FHMC/600R	£205.68	£254.44	£328.52
Width: 1100mm	Depth:- 570mm	Height:- 720mm	Requires 1 x 715 x 595 Door.			

Drawer Line Corner Base Units

All Drawer line corner units supplied with 1 x 400mm deep adjustable shelf, 4 x shelf supports, 4 x 150mm adjustable legs and 2 x Hettich soft close hinges with quick release plates. Centre posts 36mm wide x 60mm deep are fitted to all corner base units. 1 x Hettich ArchiTech soft close drawer boxes are supplied fitted. Hinge holes are drilled to both sides. All corner base units have a 52mm service recess and 18mm solid back panels. Units 1000mm wide and over are supplied with 5 x cabinet legs. A blanking panel is supplied loose with each cabinet. **The corner unit illustrated is a LEFT HAND UNIT. Drawer line corner base units are not suitable for corner wirework solutions.**

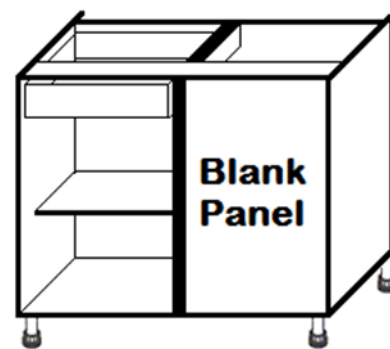

DESCRIPTION			CODE	WH	WG	WG2
800 DRAWER LINE CORNER UNIT LEFT HAND			800DLC/LH	£277.84	£320.72	£385.80
Width:- 800mm	Depth:- 570mm	Height:- 720mm	Requires 1 x 140 x 395 Drawer & 1 x 570 x 395			
800 DRAWER LINE CORNER UNIT RIGHT HAND			800DLC/RH	£277.84	£320.72	£385.80
Width:- 800mm	Depth:- 570mm	Height:- 720mm	Requires 1 x 140 x 395 Drawer & 1 x 570 x 395			
900 DRAWER LINE CORNER UNIT LEFT HAND			900DLC/LH	£282.28	£327.72	£396.72
Width:- 900mm	Depth:- 570mm	Height:- 720mm	Requires 1 x 140 x 445 Drawer & 1 x 570 x 445			
900 DRAWER LINE CORNER UNIT RIGHT HAND			900DLC/RH	£282.28	£327.72	£396.72
Width:- 900mm	Depth:- 570mm	Height:- 720mm	Requires 1 x 140 x 445 Drawer & 1 x 570 x 445			
1000 DRAWER LINE CORNER UNIT LEFT HAND			100DLC/LH	£289.04	£338.44	£413.44
Width: 1000mm	Depth:- 570mm	Height:- 720mm	Requires 1 x 140 x 495 Drawer & 1 x 570 x 495			
1000 DRAWER LINE CORNER UNIT RIGHT HAND			100DLC/RH	£289.04	£338.44	£413.44
Width: 1000mm	Depth:- 570mm	Height:- 720mm	Requires 1 x 140 x 495 Drawer & 1 x 570 x 495			
1100 D/LINE CORNER UNIT (600 DOOR) LEFT HAND			110DLC/LH	£293.72	£345.84	£425.00
Width: 1100mm	Depth:- 570mm	Height:- 720mm	Requires 1 x 140 x 595 Drawer & 1 x 570 x 595 Door			
1100 D/LINE CORNER UNIT (600 DOOR) RIGHT HAND			110DLC/RH	£293.72	£345.84	£425.00
Width: 1100mm	Depth:- 570mm	Height:- 720mm	Requires 1 x 140 x 595 Drawer & 1 x 570 x 595			

Single Built Under Oven Housing

Built under oven housings are supplied with 1 x appliance shelf to set your oven to the desired height & 4 x 150mm adjustable legs. Oven housings are not supplied with a rear panel. A rail is fitted to the front and back of the unit. The rails may have to be removed after fitting, depending of the oven and hob dimensions.

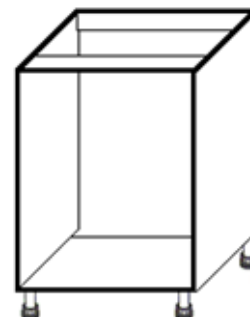

DESCRIPTION			STOCK CODE	WH	WG	WG2
B/U OVEN HOUSING			OVEN	£121.48	£144.40	£179.28
Width:- 600mm	Depth:- 570mm	Height:- 720mm	Requires 1 x 110 x 595			

Single Wall Units 720H (standard)

All 720H single wall units are supplied with 2 x adjustable shelves (260mm deep), 2 x wall hanging plates, 8 x shelf pins & 2 x Hettich soft close hinges and quick release plates. Hinge holes are drilled on both sides. Camar wall hangers are supplied fitted to the units, giving 10mm height adjustment. All wall units have a 10mm service recess.



DESCRIPTION			CODE	WH	WG	WG2
150 STANDARD 720H WALL UNIT			150SWU	£113.32	£125.16	£143.16
Width:- 150mm	Depth:- 300mm	Height:- 720mm	Requires 1 x 715 x 145 Door			
300 STANDARD 720H WALL UNIT			300SWU	£116.44	£130.12	£150.89
Width:- 300mm	Depth:- 300mm	Height:- 720mm	Requires 1 x 715 x 295 Door			

DESCRIPTION			CODE	WH	WG	WG2
350 STANDARD 720H WALL UNIT			350SWU	£118.80	£133.84	£156.68
Width:- 350mm	Depth:- 300mm	Height:- 720mm	Requires 1 x 715 x 345 Door			
400 STANDARD 720H WALL UNIT			400SWU	£120.88	£137.12	£161.82
Width:- 400mm	Depth:- 300mm	Height:- 720mm	Requires 1 x 715 x 395 Door			
450 STANDARD 720H WALL UNIT			450SWU	£123.20	£140.84	£167.60
Width:- 450mm	Depth:- 300mm	Height:- 720mm	Requires 1 x 715 x 445 Door			
500 STANDARD 720H WALL UNIT			500SWU	£125.56	£144.56	£173.16
Width:- 500mm	Depth:- 300mm	Height:- 720mm	Requires 1 x 715 x 495 Door			
550 STANDARD 720H WALL UNIT			550SWU	£127.88	£148.24	£179.16
Width:- 550mm	Depth:- 300mm	Height:- 720mm	Requires 1 x 715 x 545 Door			
600 STANDARD 720H WALL UNIT			600SWU	£130.24	£151.96	£184.96
Width:- 600mm	Depth:- 300mm	Height:- 720mm	Requires 1 x 715 x 595 Door			

300 STANDARD 720H WALL WING END			300SWE	£119.00	£130.08	£146.92
Width:- 300mm	Depth:- 300mm	Height:- 720mm	No door required (open unit)			

Double Wall Units 720H (standard)

All 720H double wall units are supplied with 2 x adjustable shelves (200mm deep), 2 x wall hanging plates, 8 x shelf pins & 4 x Hettich soft close hinges and quick release plates. Hinge holes are drilled on both sides. Camar wall hangers are supplied fitted to the units, giving 10mm height adjustment. All wall units have a 10mm service recess.

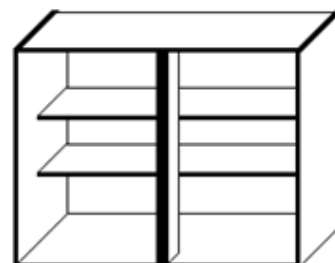

DESCRIPTION			CODE	WH	WG	WG2
700 STANDARD 720H WALL UNIT			700SWU	£167.88	£189.52	£228.07
Width:- 700mm	Depth:- 300mm	Height:- 720mm	Requires 2 x 715 x 345 Doors			
800 STANDARD 720H WALL UNIT			800SWU	£168.32	£196.12	£238.35
Width:- 800mm	Depth:- 300mm	Height:- 720mm	Requires 2 x 715 x 395 Doors			
900 STANDARD 720H WALL UNIT			900SWU	£172.72	£203.12	£249.28
Width:- 900mm	Depth:- 300mm	Height:- 720mm	Requires 2 x 715 x 445 Doors			
1000 STANDARD 720H WALL UNIT			100SWU	£176.88	£209.72	£259.56
Width: 1000mm	Depth:- 300mm	Height:- 720mm	Requires 2 x 715 x 495 Doors			
1100 STANDARD 720H WALL UNIT			110SWU	£181.32	£216.72	£270.49
Width: 1100mm	Depth:- 300mm	Height:- 720mm	Requires 2 x 715 x 545 Doors			

Curved Wall Units 720H (standard)

720 mm High curved wall units are supplied with 1 x fixed shelf in the centre of the cabinet & 2 x Hettich soft close hinges and plates. Curved wall units have no service recess & solid 18mm rear panels. Wall hangers cannot be fitted to curved wall units. To install this type of unit, installers need decide for themselves how best to secure these units to walls. A Curved wall unit will need a curved cornice & pelmet ordering from the matching accessories of your chosen door range.

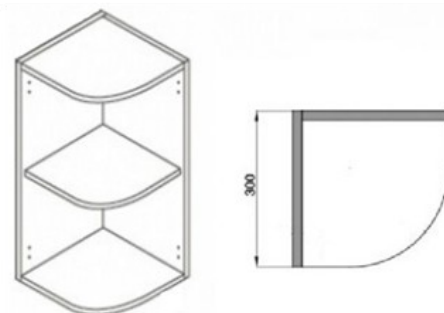

DESCRIPTION			CODE	WH	WG	WG2
CURVED 720H WALL UNIT			CURVE/WALL	£132.28	£143.52	£160.60
Width:- 300mm	Depth:- 300mm	Height:- 720mm	Requires 1 x 715 x 300 Curved Door (external)			

Bi Fold Wall Units 720H (standard)

All Bi - Fold wall units are supplied with 2 x adjustable shelves (200mm deep), 2 x wall hanging plates, 8 x shelf pins & 2 x Hettich none soft close hinges and quick release plates. The gas lift system is supplied with the unit. Hinge holes are drilled on the top panel. Camar wall hangers are supplied fitted to the units, giving 10mm height adjustment. All wall units have a 10mm service recess. **If using a J-PROFILE door with this unit please ensure the top door is ordered as a BLANK (no handle).**

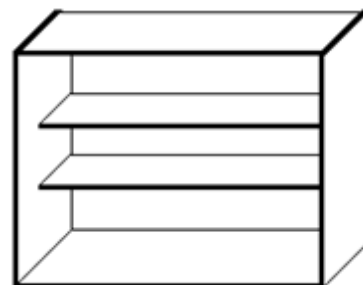

DESCRIPTION			CODE	WH	WG	WG2
500 BI-FOLD GAS LIFT 720H WALL UNIT			500BFW	£284.56	£302.80	£330.48
Width:- 500mm	Depth:- 300mm	Height:- 720mm	Requires 2 x 3555 x 495 Doors			
600 BI-FOLD GAS LIFT 720H WALL UNIT			600BFW	£288.72	£309.40	£340.80
Width:- 600mm	Depth:- 300mm	Height:- 720mm	Requires 2 x 3555 x 595 Doors			
800 BI-FOLD GAS LIFT 720H WALL UNIT			800BFW	£325.56	£351.40	£390.64
Width:- 800mm	Depth:- 300mm	Height:- 720mm	Requires 2 x 355 x 795 Doors			
900 BI-FOLD GAS LIFT 720H WALL UNIT			900BFW	£329.72	£358.00	£400.92
Width:- 900mm	Depth:- 300mm	Height:- 720mm	Requires 2 x 355 x 895 Doors			
1000 BI-FOLD GAS LIFT 720H WALL UNIT			100BFW	£334.16	£365.00	£411.84
Width:-1000mm	Depth:- 300mm	Height:- 720mm	Requires 2 x 355 x 995 Doors			

Bridging Units 360H / 288H

All 360H and 288H bridging units are supplied with no shelf. Hinge holes are drilled on the top panel, 2 x wall hanging plates, a gas lift stay, 2 x Hettich soft close hinges and quick release plates are also supplied. Camar wall hangers are supplied fitted to the units, giving 10mm height adjustment. All wall units have a 10mm service recess.

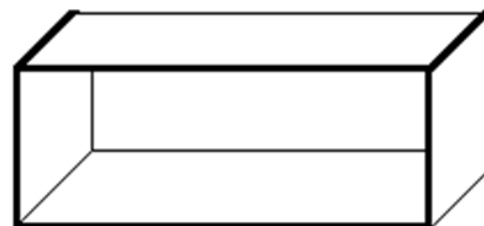

DESCRIPTION			CODE	WH	WG	WG2
500 BRIDGING UNIT (360H)			500SBU	£112.16	£121.72	£136.24
Width:- 500mm	Depth:- 300mm	Height:- 360mm	Requires 1 x 355 x 495 Door			
600 BRIDGING UNIT (360H)			600SBU	£114.48	£125.44	£142.04
Width:- 600mm	Depth:- 300mm	Height:- 360mm	Requires 1 x 355 x 595 Door			
800 BRIDGING UNIT (360H)			800SBU	£123.16	£136.84	£157.60
Width:- 800mm	Depth:- 300mm	Height:- 360mm	Requires 1 x 355 x 495 Door			
900 BRIDGING UNIT (360H)			900SBU	£127.84	£144.24	£169.18
Width:- 900mm	Depth:- 300mm	Height:- 360mm	Requires 1 x 355 x 895 Door			
1000 BRIDGING UNIT (360H)			100SBU	£127.84	£144.24	£169.18
Width: 1000mm	Depth:- 300mm	Height:- 360mm	Requires 1 x 355 x 995 Door			

DESCRIPTION			CODE	WH	WG	WG2
500 BRIDGING UNIT (288H)			500STB	£110.08	£118.44	£131.12
Width:- 500mm	Depth:- 300mm	Height:- 288mm	Requires 1 x 283 x 495 Door			
600 BRIDGING UNIT (288H)			600STB	£112.16	£121.72	£136.24
Width:- 600mm	Depth:- 300mm	Height:- 288mm	Requires 1 x 283 x 595 Door			
800 BRIDGING UNIT (288H)			800STB	£120.56	£132.72	£151.20
Width:- 800mm	Depth:- 300mm	Height:- 288mm	Requires 1 x 283 x 795 Door			
900 BRIDGING UNIT (288H)			900STB	£122.64	£136.00	£156.32
Width:- 900mm	Depth:- 300mm	Height:- 288mm	Requires 1 x 283 x 895 Door			
1000 BRIDGING UNIT (288H)			100STB	£124.72	£139.32	£161.48
Width: 1000mm	Depth:- 300mm	Height:- 288mm	Requires 1 x 283 x 995 Door			

Glass Display Units 720H

All 720H glass display wall units are supplied with 2 x adjustable glass shelves (220mm deep), 2 x wall hanging plates, 8 x suction shelf pins & 2 x Hettich soft close hinges and quick release plates. Hinge holes are drilled on both sides. Camar wall hangers are supplied fitted to the units, giving 10mm height adjustment. All wall units have a 10mm service recess. Please ensure you are happy with the glass type available in you chosen range (ie clear/frosted glass). Fitting a light inside a glass unit is an excellent way to complement your display cabinet.

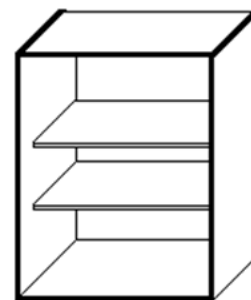

DESCRIPTION			CODE	WH	WG	WG2
400 STANDARD GLASS 720H WALL UNIT			400SGW	£184.32	£197.84	£218.36
Width:- 400mm	Depth:- 300mm	Height:- 720mm	Requires 1 x 715 x 395 Glazed Frame			
500 STANDARD GLASS 720H WALL UNIT			500SGW	£198.12	£213.44	£236.76
Width:- 500mm	Depth:- 300mm	Height:- 720mm	Requires 1 x 715 x 495 Glazed Frame			
600 STANDARD GLASS 720H WALL UNIT			600SGW	£221.20	£238.52	£264.84
Width:- 600mm	Depth:- 300mm	Height:- 720mm	Requires 1 x 715 x 595 Glazed Frame			

Glass Dresser Units 1210H

All 1210mm glass dresser units are supplied with 2 x adjustable glass shelves (220mm deep), 2 x wall hanging plates, 8 x suction shelf pins & 2 x Hettich soft close hinges and quick release plates. 2 x Hettich ArchiTech soft close drawer boxes are supplied fitted to the bottom of the cabinet. Hinge holes are drilled on both sides. Camar wall hangers are supplied fitted to the units, giving 10mm height adjustment. All dresser units have a 10mm service recess. Please ensure you are happy with the glass type available in you chosen range (ie clear/frosted glass). Fitting a light inside a glass dresser is an excellent way to complement your display cabinet.

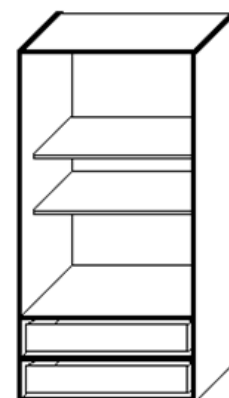

DESCRIPTION			CODE	WH	WG	WG2
500 GLASS DRESSER UNIT FOR STANDARD WALL 1210H			500SDU/TAN	£462.12	£489.16	£530.24
Width:- 500mm	Depth:- 300mm	Height: 1210mm	Requires 1 x 895 x 495 Glazed Frame & 2 x 140 x 495 Drawer			

635 Corner Wall Units 720H

All 635 x 720H corner wall units are supplied with 2 x adjustable shelves (200mm deep), 2 x wall hanging plates, 8 x shelf pins & 2 x Hettich soft close hinges and quick release plates. Hinge holes are drilled on both sides. Camar wall hangers are supplied fitted to the units, giving 10mm height adjustment. All wall units have a 10mm service recess. A corner blanking panel is supplied loose with each cabinet.

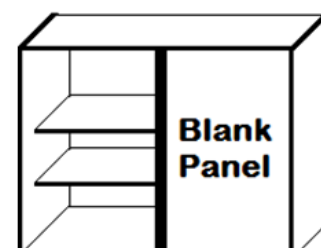

DESCRIPTION			CODE	WH	WG	WG2
635 STANDARD CORNER 720H WALL UNIT			600SCW	£159.60	£186.80	£228.12
Width:- 600mm	Depth:- 300mm	Height:- 720mm	Requires 1 x 715 x 295			

Diagonal Corner Wall Units 720H



All 720H diagonal corner wall units are supplied with 2 x adjustable full depth shelves 2 x wall hanging plates, 8 x shelf pins & 2 x Hettich 45 degree soft close hinges and quick release plates. Hinge holes are drilled on both sides. Camar wall hangers are supplied fitted to the units, giving 10mm height adjustment. All wall units have a 10mm service recess.

DESCRIPTION			CODE	WH	WG	WG2
600 STANDARD DIAGONAL CORNER WALL UNIT			600SDC	£180.64	£220.16	£280.16
Width:- 600mm	Depth:- 600mm	Height:- 720mm	Requires 1 x 715 x 395			

600 x 600 Corner Wall Units 720H

All 720H L shaped corner wall units are supplied with 2 x adjustable full depth shelves 2 x wall hanging plates, 12 x shelf pins & 2 x Hettich 165 degree soft close hinges with quick release plates and 2 x bi fold hinges with face fixing screw on plates. Hinge holes are drilled on both sides. Camar wall hangers are supplied fitted to the units, giving 10mm height adjustment. All wall units have a 10mm service recess.

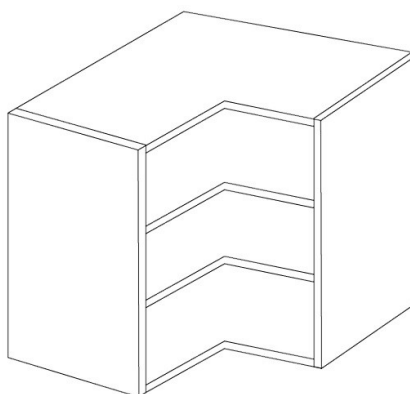
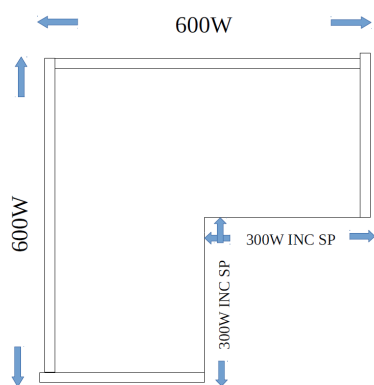

DESCRIPTION			CODE	WH	WG	WG2
600 x 600 STANDARD L SHAPE CORNER WALL UNIT			600SLCW	£277.56	£317.08	£377.08
Width:- 600mm	Depth:- 600mm	Height:- 720mm	Requires 2 x 715 x 273			

618 x 618 Corner Wall Units 720H*

* PLEASE NOTE, THIS CABINET IS NOT SUITABLE FOR J-PROFILE DOOR RANGES.

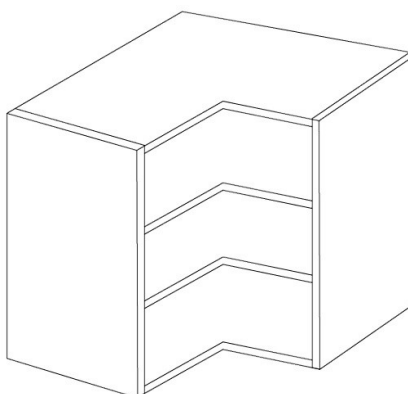
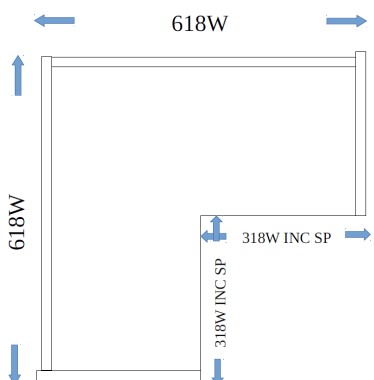

DESCRIPTION			CODE	WH	WG	WG2
618 x 618 STANDARD L SHAPE CORNER WALL UNIT			600SLCW	£277.56	£317.08	£377.08
Width:- 618mm	Depth:- 618mm	Height:- 720mm	Requires 2 x 715 x 295			

Standard Larder Units 1970H



All 1970H larder units supplied with 5 x 400mm deep adjustable shelves 20 x shelf supports, 4 x 150mm adjustable legs and 4 x Hettich soft close hinges with quick release plates. Hinge holes are drilled to both sides. All larder units have a 52mm service recess and 18mm solid back panels. A limited number of our door ranges are available with a full height single door, J-Profile full height doors have handles running vertically.

DESCRIPTION			CODE	WH	WG	WG2
300 STANDARD LARDER UNIT 1970H			300SLU	£272.80	£326.56	£408.31
Width:- 300mm	Depth:- 570mm	Height: 1970mm	Requires 1 x 715 x 295 & 1 x 1245 x 295			
300 STANDARD LARDER UNIT FULL HEIGHT DOOR			FHD300SLU	£272.80	£326.56	£408.31
Width:- 300mm	Depth:- 570mm	Height: 1970mm	Requires 1 x 1965 x 295			
400 STANDARD LARDER UNIT 1970H			400SLU	£285.80	£347.20	£440.45
Width:- 400mm	Depth:- 570mm	Height: 1970mm	Requires 1 x 715 x 395 & 1 x 1245 x 395			
400 STANDARD LARDER UNIT FULL HEIGHT DOOR			FHD400SLU	£285.80	£347.20	£440.45
Width:- 400mm	Depth:- 570mm	Height: 1970mm	Requires 1 x 1965 x 395			
500 STANDARD LARDER UNIT 1970H			500SLU	£298.80	£379.80	£472.59
Width:- 500mm	Depth:- 570mm	Height: 1970mm	Requires 1 x 715 x 495 & 1 x 1245 x 495			
500 STANDARD LARDER UNIT FULL HEIGHT DOOR			FHD500SLU	£298.80	£379.80	£472.59
Width:- 500mm	Depth:- 570mm	Height: 1970mm	Requires 1 x 1965 x 495			
600 STANDARD LARDER UNIT 1970H			600SLU	£311.56	£388.00	£504.09
Width:- 600mm	Depth:- 570mm	Height: 1970mm	Requires 1 x 715 x 595 & 1 x 1245 x 595			
600 STANDARD LARDER UNIT FULL HEIGHT DOOR			FHD600SLU	£311.56	£388.00	£504.09
Width:- 600mm	Depth:- 570mm	Height: 1970mm	Requires 1 x 1965 x 595			

Standard Curved Larder Units 1970H

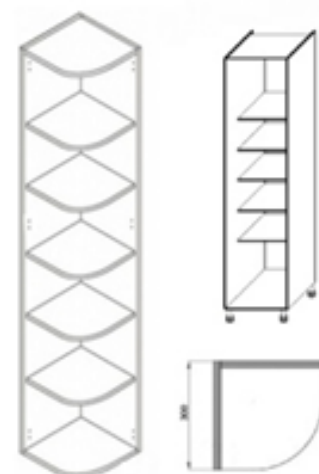

Curved larder units can be used to complete a bank of larder units. A 260mm wide 300mm deep unit can be used to access the space from behind the unit, or a larder panel can be used to blank the space. All curved larder units have 5 fixed shelves spaced equally along the height of the unit, 4 x 150mm adjustable legs and 4 x Hettich soft close hinges with quick release plates. A Curved larder unit will need a curved plinth ordering from the matching accessories of your chosen door range.

DESCRIPTION			CODE	WH	WG	WG2
260 LARDER UNIT 1970H (300DEEP FOR CURVED)			260SLU	£233.80	£264.80	£311.88
Width:- 260mm	Depth:- 300mm	Height: 1970mm	Requires 1 x 715 x 255 & 1 x 1245 x 255 Doors			
300 CURVED LARDER UNIT 1970H			CURV/LAR	£332.80	£386.56	£467.67
Width:- 300mm	Depth:- 300mm	Height: 1970mm	Requires 1 x 715 x 300 & 1 x 1245 x 300 curved Doors			

Single Wall Units 900H (tall)

All 900H single wall units are supplied with 3 x adjustable shelves (260mm deep), 2 x wall hanging plates, 12 x shelf pins & 2 x Hettich soft close hinges and quick release plates. Hinge holes are drilled on both sides. Camar wall hangers are supplied fitted to the units, giving 10mm height adjustment. All wall units have a 10mm service recess.

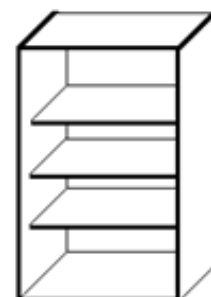

DESCRIPTION			CODE	WH	WG	WG2
300 TALL 900H WALL UNIT			300TWU	£122.80	£139.84	£165.67
Width:- 300mm	Depth:- 300mm	Height:- 900mm	Requires 1 x 895 x 295 Door			
400 TALL 900H WALL UNIT			400TWU	£128.52	£148.88	£179.82
Width:- 300mm	Depth:- 300mm	Height:- 900mm	Requires 1 x 895 x 395 Door			
450 TALL 900H WALL UNIT			450TWU	£131.40	£153.44	£186.89
Width:- 300mm	Depth:- 300mm	Height:- 900mm	Requires 1 x 895 x 445 Door			
500 TALL 900H WALL UNIT			500TWU	£134.24	£157.96	£193.96
Width:- 300mm	Depth:- 300mm	Height:- 900mm	Requires 1 x 895 x 495 Door			
600 TALL 900H WALL UNIT			600TWU	£140.24	£167.44	£208.74
Width:- 300mm	Depth:- 300mm	Height:- 900mm	Requires 1 x 895 x 595 Door			
300X300 TALL 900H WALL WING END UNIT			300TWE	£121.84	£134.60	£154.00
Width:- 300mm	Depth:- 300mm	Height:- 900mm	No door required (open unit)			

Double Wall Units 900H (tall)

All 900H double wall units are supplied with 3 x adjustable shelves (200mm deep), 2 x wall hanging plates, 12 x shelf pins & 4 x Hettich soft close hinges and quick release plates. Hinge holes are drilled on both sides. Camar wall hangers are supplied fitted to the units, giving 10mm height adjustment. All wall units have a 10mm service recess.

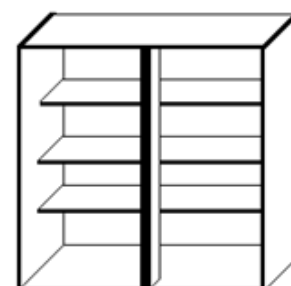

DESCRIPTION			STOCK CODE	WH	WG	WG2
800 TALL 900H WALL UNIT			800TWU	£180.40	£214.88	£267.28
Width:- 800mm	Depth:- 300mm	Height:- 900mm	Requires 2 x 895 x 395 Doors			
900 TALL 900H WALL UNIT			900TWU	£185.60	£223.12	£280.13
Width:- 900mm	Depth:- 300mm	Height:- 900mm	Requires 2 x 895 x 445 Doors			
1000 TALL 900H WALL UNIT			100TWU	£190.80	£231.36	£292.99
Width: 1000mm	Depth:- 300mm	Height:- 900mm	Requires 2 x 895 x 495 Doors			

Curved Wall Units 900H (tall)

9000 mm High curved wall units are supplied with 2 x fixed shelves spaced equally across the cabinet & 2 x Hettich soft close hinges and plates. Curved wall units have no service recess & solid 18mm rear panels. Wall hangers cannot be fitted to curved wall units. To install this type of unit, installers need decide for themselves how best to secure these units to walls. A Curved wall unit will need a curved cornice & pelmet ordering from the matching accessories of your chosen door range.

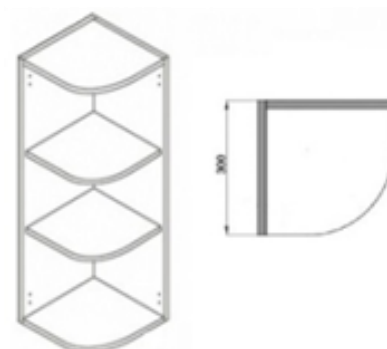

DESCRIPTION			CODE	WH	WG	WG2
TALL 900H CURVED WALL UNIT			TWCURV	£143.20	£155.96	£175.36
Width:- 300mm	Depth:- 300mm	Height:- 900mm	Requires 1 x 895 x 300 Curved Door (external)			

Glass Display Units 900H

All 900H glass display wall units are supplied with 2 x adjustable glass shelves (220mm deep), 2 x wall hanging plates, 8 x suction shelf pins & 2 x Hettich soft close hinges and quick release plates. Hinge holes are drilled on both sides. Camar wall hangers are supplied fitted to the units, giving 10mm height adjustment. All wall units have a 10mm service recess. Please ensure you are happy with the glass type available in you chosen range (ie clear/frosted glass). Fitting a light inside a glass unit is an excellent way to complement your display cabinet.

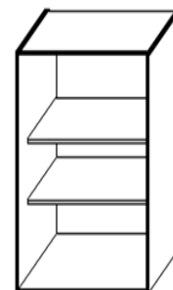

DESCRIPTION			CODE	WH	WG	WG2
500 TALL GLASS 900H WALL UNIT			500TGW	£198.12	£213.44	£236.76
Width:- 500mm	Depth:- 300mm	Height:- 900mm	Requires 1 x 895 x 495 Glazed Frame			

Glass Dresser Units 1390H

All 1390mm glass dresser units are supplied with 2 x adjustable glass shelves (220mm deep), 2 x wall hanging plates, 8 x suction shelf pins & 2 x Hettich soft close hinges and quick release plates. 2 x Hettich ArchiTech soft close drawer boxes are supplied fitted to the bottom of the cabinet. Hinge holes are drilled on both sides. Camar wall hangers are supplied fitted to the units, giving 10mm height adjustment. All dresser units have a 10mm service recess. Please ensure you are happy with the glass type available in you chosen range (ie clear/frosted glass). Fitting a light inside a glass dresser is an excellent way to complement your display cabinet.

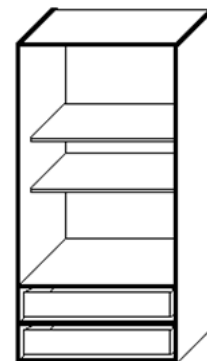

DESCRIPTION			CODE	WH	WG	WG2
500 GLASS DRESSER UNIT FOR TALL WALL 1390H			500TDU/TAN	£467.08	£497.00	£542.48
Width:- 500mm	Depth:- 300mm	Height: 1210mm	Requires 1 x 1060 x 495 Glazed Frame & 1 x 140 x 495 & 1 x 175 x 495 Drawer			

635 Corner Wall Units 900H

All 635 x 900H corner wall units are supplied with 3 x adjustable shelves (200mm deep), 2 x wall hanging plates, 12 x shelf pins & 2 x Hettich soft close hinges and quick release plates. Hinge holes are drilled on both sides. Camar wall hangers are supplied fitted to the units, giving 10mm height adjustment. All wall units have a 10mm service recess. A corner blanking panel is supplied loose with each cabinet.

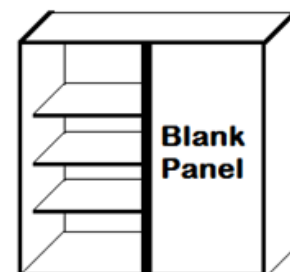

DESCRIPTION			CODE	WH	WG	WG2
635 TALL CORNER 900H WALL UNIT			600TCW	£170.76	£206.28	£255.76
Width:- 600mm	Depth:- 300mm	Height:- 900mm	Requires 1 x 895 x 295			

All 900H diagonal corner wall units are supplied with 3 x adjustable full depth shelves 2 x wall hanging plates, 12 x shelf pins & 2 x Hettich 45 degree soft close hinges and quick release plates. Hinge holes are drilled on both sides. Camar wall hangers are supplied fitted to the units, giving 10mm height adjustment. All wall units have a 10mm service recess.



DESCRIPTION			CODE	WH	WG	WG2
600 TALL DIAGONAL CORNER WALL UNIT			600TDC	£197.80	£247.36	£322.60
Width:- 600mm	Depth:- 600mm	Height:- 900mm	Requires 1 x 895 x 395			

618 x 618 Corner Wall Units 900H*

All 900H L shaped corner wall units are supplied with 3 x adjustable full depth shelves 2 x wall hanging plates, 18 x shelf pins & 2 x Hettich 165 degree soft close hinges with quick release plates and 2 x bi fold hinges with face fixing screw on plates. Hinge holes are drilled on both sides. Camar wall hangers are supplied fitted to the units, giving 10mm height adjustment. All wall units have a 10mm service recess.

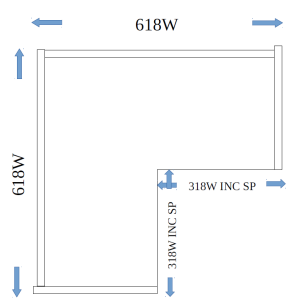
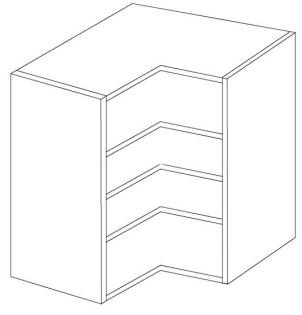

* PLEASE NOTE, THIS CABINET IS NOT SUITABLE FOR J-PROFILE DOOR RANGES.

DESCRIPTION			CODE	WH	WG	WG2
618 x 618 STANDARD L SHAPE CORNER WALL UNIT			600SLCW	£357.56	£397.08	£457.08
Width:- 618mm	Depth:- 618mm	Height:- 900mm	Requires 2 x 715 x 895			

Tall Larder Units 2150H

All 2150H larder are suitable for use with 900H tall wall units. 2150H larder units are supplied with 5 x 400mm deep adjustable shelves 20 x shelf supports, 4 x 150mm adjustable legs and 4 x Hettich soft close hinges with quick release plates. Hinge holes are drilled to both sides. All larder units have a 52mm service recess and 18mm solid back panels.



DESCRIPTION			CODE	WH	WG	WG2
300 TALL LARDER UNIT 2150H			300TLU	£279.32	£336.92	£424.38
Width:- 300mm	Depth:- 570mm	Height: 2150mm	Requires 1 x 895 x 295 & 1 x 1245 x 295			
400 TALL LARDER UNIT 2150H			400TLU	£292.84	£358.36	£457.81
Width:- 400mm	Depth:- 570mm	Height: 2150mm	Requires 1 x 895 x 395 & 1 x 1245 x 395			
500 TALL LARDER UNIT 2150H			500TLU	£306.08	£379.36	£490.56
Width:- 500mm	Depth:- 570mm	Height: 2150mm	Requires 1 x 895 x 495 & 1 x 1245 x 495			
600 TALL LARDER UNIT 2150H			600TLU	£319.60	£400.76	£524.00
Width:- 600mm	Depth:- 570mm	Height: 2150mm	Requires 1 x 895 x 595 & 1 x 1245 x 595			

Microwave Wall Units 720H & 900H

All wall unit microwave housings units are supplied with no shelf, 2 x Hettich soft close hinges & quick release plates, 2 x wall hanging plates and a gas lift bridging stay. Hinge holes are drilled on the top panel. Wall hangers are supplied fitted to the units, giving 10mm height adjustment. A drawer front is required to use as a filler, this will need cutting down to the required size. All wall units have a 10mm service recess

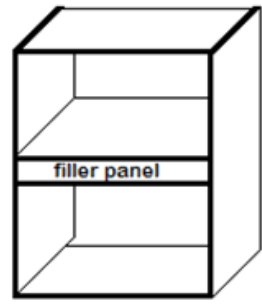

DESCRIPTION			CODE	WH	WG	WG2
500 STANDARD MICRO WALL UNIT 720H			500SMICRO	£122.56	£136.84	£158.56
Width:- 500mm	Depth:- 300mm	Height:- 720mm	Requires 1 x 283 x 495 & 1 x 140 x 595			
600 STANDARD MICRO WALL UNIT 720H			600SMICRO	£125.44	£141.40	£165.60
Width:- 600mm	Depth:- 300mm	Height:- 720mm	Requires 1 x 283 x 595 & 1 x 140 x 595			
600 TALL MICRO WALL UNIT 900H			600TMICRO	£130.64	£149.64	£178.48
Width:- 600mm	Depth:- 300mm	Height:- 900mm	Requires 1 x 450 x 595 & 1 x 140 x 595			

Fridge Freezer Housings 1970H & 2150H

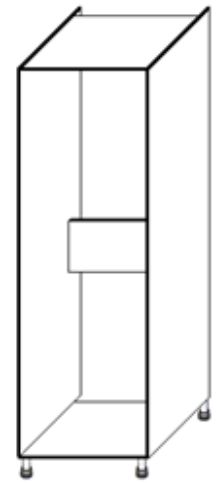

All fridge freezer housings are supplied with 2 x appliance shelves to set your fridge freezer to the desired height, 4 x Hettich none soft close hinges and 4 x 150mm cabinet legs. When setting the height of your fridge freezer ensure the appliance doors are positioned in line with the cabinet doors. The housing has a ventilation gap at the top and bottom of the housing. All fridge freezer housings do not have a rear panel, a rail is fitted to the back of the unit to keep them square during delivery and installation, the rail must be removed prior to installing the appliance.

DESCRIPTION			CODE	WH	WG	WG2
STAN 50/50 FRIDGE FREEZER HOUSING 1970H			S50/50FF	£277.52	£338.00	£429.88
Width:- 600mm	Depth:- 570mm	Height: 1970mm	Requires 2 x 980 x 595 & 1 x Doors			
STAN 70/30 FRIDGE FREEZER HOUSING 1970H			S70/30FF	£277.52	£338.00	£429.88
Width:- 600mm	Depth:- 570mm	Height: 1970mm	Requires 1 x 715 x 595 & 1 x 1245 x 595 Doors			
TALL 50/50 FRIDGE FREEZER HOUSING 2150H			T50/50FF	£282.72	£346.24	£442.72
Width:- 600mm	Depth:- 570mm	Height: 2150mm	Requires 2 x 980 x 595 doors & 1 x 175 x 595			
TALL 70/30 FRIDGE FREEZER HOUSING 2150H			T70/30FF	£282.72	£346.24	£442.72
Width:- 600mm	Depth:- 570mm	Height: 2150mm	Requires 1 x 715 x 595, 1 x 1245 x 595 & 1 x 175 x 595			

DESCRIPTION			CODE	WH	WG	WG2
LARDER FRIDGE OR FREEZER HOUSING 1970H			SLAR	£277.52	£338.00	£429.88
Width:- 600mm	Depth:- 570mm	Height: 1970mm	Requires 1 x 1965 x 595 Door			
LARDER FRIDGE OR FREEZER HOUSING 2150H			TLAR	£282.72	£346.24	£442.72
Width:- 600mm	Depth:- 570mm	Height: 2150mm	Requires 1 x 175 x 595 & 1 x 1965 x 595 Doors			

Single Oven Housings 1970H

Single oven housings are available in 2 options, the 1st option has a cupboard above and below with a shelf in each. The 2nd option has a 140mm drawer under the oven ideal for baking trays etc, a shelf in the bottom cupboard but not in the top. Both options are supplied with 4 x Hettich soft close hinges and quick #release plates, shelf pins and 4 x 150mm adjustable legs. An appliance shelf is supplied with this cabinet to set your oven to the desired Height. The oven section has no rear panel but the rest of the cabinet has 18mm rear panels and a service recess of 52mm.

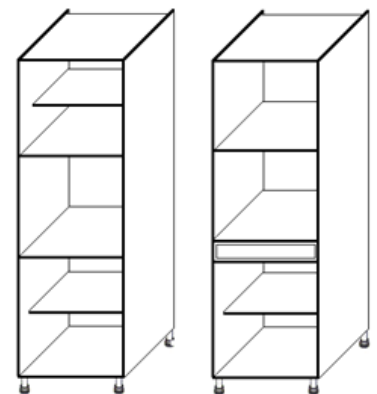

DESCRIPTION			CODE	WH	WG	WG2
STANDARD SINGLE OVEN HOUSING WITH DRAWER			SS/OVEN	£356.76	£426.08	£531.32
Width:- 600mm	Depth:- 570mm	Height: 1970mm	Requires 1 x 715 x 595 & 1 x 490 x 595 & 1 x 140 x 595			
STANDARD SINGLE OVEN HOUSING 645H TOP DOOR			SS/OVEN2	£296.76	£366.08	£471.32
Width:- 600mm	Depth:- 570mm	Height: 1970mm	Requires 1 x 715 x 595 & 1 x 645 x 595			

Single Oven Housing 2150H

Tall single oven housings have a cupboard above and below with a shelf in each, also supplied with 4 x Hettich soft close hinges and quick release plates, shelf pins and 4 x 150mm adjustable legs. An appliance shelf is supplied with this cabinet to set your oven to the desired Height. A 110mm high blanking panel is required for above the oven. The oven section has no rear panel but the rest of the cabinet has 18mm rear panels and a service recess of 52mm.

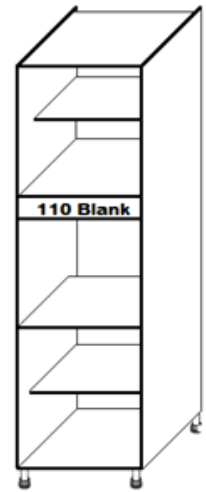

DESCRIPTION			CODE	WH	WG	WG2
TALL SINGLE OVEN HOUSING 2150H			TS/OVEN	£311.32	£389.16	£507.32
Width:- 600mm	Depth:- 570mm	Height: 2150mm	Requires 2 x 715 x 595 doors & 1 x 110 x 595 Blank			

Double Oven Housings 1970H

Double oven housings are available in 2 options, the 1st option has a cupboard above and below with a shelf in the bottom unit, 4 x Hettich soft close hinges and quick release plates, 4 x shelf pins and 4 x 150mm adjustable legs. The 2nd option is supplied with 2 x 283mm pan drawers under the oven, 2 x Hettich soft close hinges and quick release plates, and 4 x 150mm adjustable legs. An appliance shelf is supplied with this cabinet to set your oven to the desired Height. The oven section has no rear panel but the rest of the cabinet has 18mm rear panels and a service recess of 52mm.

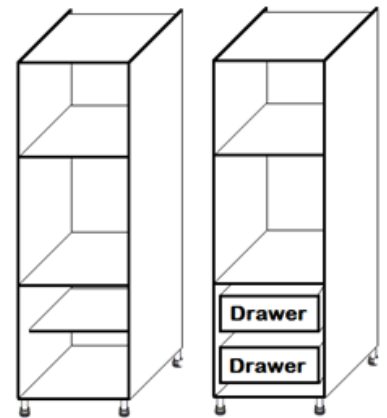

DESCRIPTION			SCODE	WH	WG	WG2
STANDARD DOUBLE OVEN HOUSING 1970H			SD/OVEN	£302.24	£374.72	£484.80
Width:- 600mm	Depth:- 570mm	Height: 1970mm	Requires 1 x 570 x 595 & 1 x 490 x 595			
STANDARD D/OVEN HOUSING (2PAN) 1970H			SD/OVEN/2TAN	£577.92	£650.40	£760.48
Width:- 600mm	Depth:- 570mm	Height: 1970mm	Requires 2 x 283 x 595 & 1 x 490 x 595			

Double Oven Housing 2150H

Tall double oven housings are available in 2 options, the 1st option has a cupboard above and below with a shelf in the bottom unit, 4 x Hettich soft close hinges and quick release plates, 4 x shelf pins and 4 x 150mm adjustable legs. The 2nd option is supplied with 2 x 283mm pan drawers under the oven, 2 x Hettich soft close hinges and quick release plates, and 4 x 150mm adjustable legs. An appliance shelf is supplied with this cabinet to set your oven to the desired Height. A 175 x 595 filler is required for above the oven, when using for a single oven and 380h microwave this panel will need to be cut down. The oven section has no rear panel but the rest of the cabinet has 18mm rear panels and a service recess of 52mm

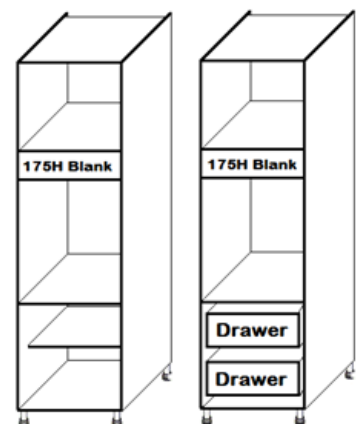

DESCRIPTION			CODE	WH	WG	WG2
TALL DOUBLE OVEN HOUSING 2150H			TD/OVEN	£307.44	£382.96	£497.68
Width:- 600mm	Depth:- 570mm	Height: 2150mm	Requires 1 x 570 x 595, 1 x 490 x 595 & 1 x 175 x 595			
TALL D/OVEN HOUSING (2PAN) 2150H			TD/OVEN/2TAN	£583.12	£658.64	£773.36
Width:- 600mm	Depth:- 570mm	Height: 2150mm	Requires 1 x 570 x 595 & 2 x 283 x 595 & 1 x 175 x 595			

Single Oven & Microwave Housing 1970H

1970H single oven & microwave housings are available in 2 options. The 1st option is for microwaves between 450 – 460mm high. The 2nd option is for microwaves between 380 – 390mm high. Supplied with 4 x Hettich soft close hinges and quick release plates and 4 x 150mm adjustable legs. 2 X appliance shelves are supplied with this cabinet to set your oven & microwave to the desired Height. This cabinet has an equal sided cupboard above and below the appliances. The oven & microwave section has no rear panel but the rest of the cabinet has 18mm rear panels and a service recess of 52mm.

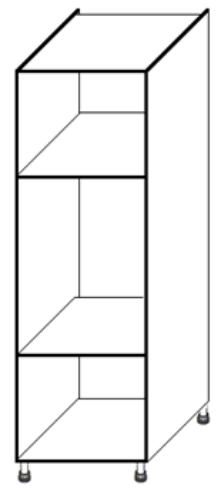

DESCRIPTION			STOCK CODE	WH	WG	WG2
STAN SINGLE OVEN & 460H MICRO HOUSING 1970H			SS/OVENSOM2	£301.44	£373.48	£482.88
Width:- 600mm	Depth:- 570mm	Height: 1970mm	Requires 2 x 450 x 595 doors			
STAN SINGLE OVEN & 380H MICRO HOUSING 1970H			SS/OVENSOM1	£294.32	£362.56	£466.16
Width:- 600mm	Depth:- 570mm	Height: 1970mm	Requires 2 x 490 x 595 doors			

Single Oven & Microwave Housing 2150H

2150H single oven & microwave housings suitable for microwaves or compact appliances between 450 – 460mm high. Supplied with 4 x Hettich soft close hinges and quick release plates and 4 x 150mm adjustable legs. 2 X appliance shelves are supplied with this cabinet to set your oven & microwave to the desired Height. This cabinet has an equal sided cupboard above and below the appliances. A 175mm H filler panel is required to fill the leftover space above the appliances. The oven & microwave section has no rear panel but the rest of the cabinet has 18mm rear panels and a service recess of 52mm.

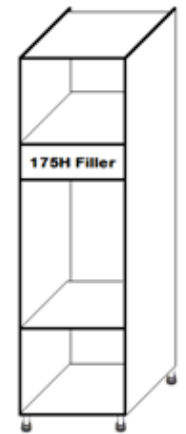

DESCRIPTION			CODE	WH	WG	WG2
TALL SINGLE OVEN & 460H MICRO HOUSING 2150H			TS/OVENSOM2	£306.92	£382.16	£496.40
Width:- 600mm	Depth:- 570mm	Height: 2150mm	Requires 2 x 450 x 595 doors & 1 x 175 x 595 Blank			

Double Oven Mid Height Housing 1470H

1470H double oven midi units are available in 2 options. The 1st option has a cupboard below with an adjustable shelf, supplied with 4 x shelf pins, 2 x Hettich soft close hinges and quick release plates and 4 x 150mm adjustable legs. The 2nd option has 2 x 283mm pan drawers below the oven space & 4 x 150mm adjustable legs. An appliance shelf is supplied with this cabinet to set your oven to the desired Height. The oven section has no rear panel but the rest of the cabinet has 18mm rear panels and a service recess of 52mm.

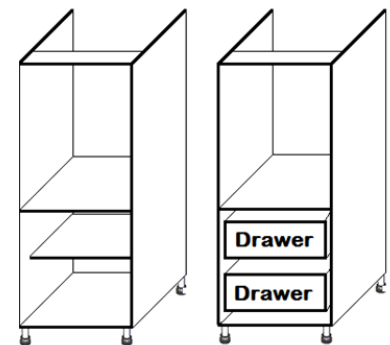

DESCRIPTION			CODE	WH	WG	WG2
600 DOUBLE OVEN MIDI UNIT 1470H			DOMIDI	£253.48	£301.96	£375.56
Width:- 600mm	Depth:- 570mm	Height: 1470mm	Requires 1 x 570 x 595			
600 DOUBLE OVEN MIDI UNIT 1470H (2XPAN)			DOM/2TAN	£529.16	£577.64	£651.24
Width:- 600mm	Depth:- 570mm	Height: 1470mm	Requires 2 x 283 x 595			

Mid Height Unit / Fridge Housing 1470H

1470H midi units are available in 2 options, the 1st option has a cupboard above and below with a shelf in the bottom unit and 2 shelves in the top unit supplied with 12 x shelf pins, 4 x Hettich soft close hinges and quick release plates and 4 x 150mm adjustable legs. The 2nd option has 2 x 283mm pan drawers in the bottom section, & 2 x shelves above, supplied with 8 x shelf pins, 2 x Hettich soft close hinges and quick release plates and 4 x 150mm adjustable legs. This unit can also be made to accommodate a 900H larder fridge or freezer in the top section, just add a note mentioning the appliance and we won't put shelves or a back in the top section. The cabinet has 18mm rear panels and a service recess of 52mm.

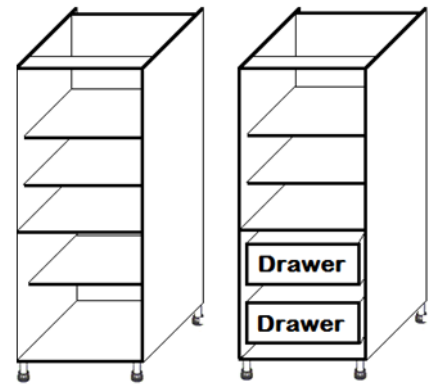

DESCRIPTION			CODE	WH	WG	WG2
600 MIDI UNIT 1470H (ALSO FRIDGE MIDI) 2 X PAN			600MUA/TAN	£523.68	£563.32	£623.56
Width:- 600mm	Depth:- 570mm	Height: 1470mm	Requires 1 x 895 x 595 & 2 x 283 x 595			
600 MIDI UNIT 1470H (ALSO FRIDGE MIDI)			600MIDI	£276.72	£333.56	£419.88
Width:- 600mm	Depth:- 570mm	Height: 1470mm	Requires 1 x 895 x 595 & 1 x 570 x 595			

Single Oven Mid Height Unit 1470H

1470H single oven midi units Have a cupboard below with a shelf & have 1 x Hettich Architec 140mm drawer under the oven opening, supplied with 4 x shelf pins, 2 x Hettich soft close hinges and quick release plates and 4 x 150mm adjustable legs. An appliance shelf is supplied with this cabinet to set your oven to the desired Height. The oven section has no rear panel but the rest of the cabinet has 18mm rear panels and a service recess of 52mm

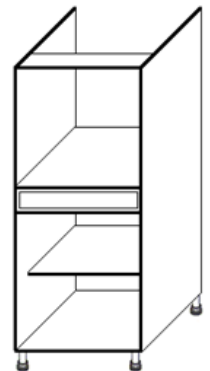

DESCRIPTION			CODE	WH	WG	WG2
1470H SINGLE OVEN MIDI HOUSING WITH DRAWER			SOMIDI/TAN	£391.88	£442.96	£520.52
Width:- 600mm	Depth:- 570mm	Height: 1470mm	Requires 1 x 715 x 595 & 1 x 140 x 595			

Single Oven & Microwave Mid Height Unit 1470H

1470H single oven & microwave midi units Have an Hettich Architec pan drawer & 140mm drawer under the oven opening, supplied with 4 x 150mm adjustable legs. An appliance shelf is supplied with this cabinet to set your oven to the desired Height. The oven & microwave section has no rear panel but the rest of the cabinet has 18mm rear panels and a service recess of 52mm

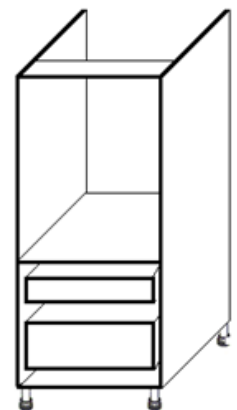

DESCRIPTION			CODE	WH	WG	WG2
1470H SINGLE OVEN & MICRO MIDI 2 DRAWER			SMMI/2TAN	£474.08	£513.12	£573.96
Width:- 600mm	Depth:- 570mm	Height: 1470mm	Requires 1 x 283 x 595 & 1 x 140 x 595			

Double Oven Mid Height Housing 1250H

2570H Double midi units Have an Hettich Architec pan drawer under the oven opening, supplied with 4 x 150mm adjustable legs. An appliance shelf is supplied with this cabinet to set your oven to the desired Height. The oven & microwave section has no rear panel but the rest of the cabinet has 18mm rear panels and a service recess of 52mm

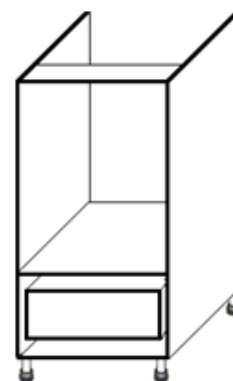

DESCRIPTION			CODE	WH	WG	WG2
1250H DOUBLE OVEN MIDI HOUSING 1 PAN DRAWER			1250DOM	£379.16	£427.64	£501.24
Width:- 600mm	Depth:- 570mm	Height: 1470mm	Requires 1 x 355 x 595			

Single Oven Mid Height Housing 1250H

1250H single oven midi units Have 2 x Hettich Architec pan drawers under the oven opening, supplied with 4 x 150mm adjustable legs. An appliance shelf is supplied with this cabinet to set your oven to the desired Height. The oven section has no rear panel but the rest of the cabinet has 18mm rear panels and a service recess of 52mm

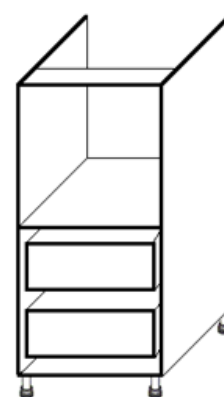

DESCRIPTION			CODE	WH	WG	WG2
1250HSINGLE OVEN MIDI HOUSING 2 PAN DRAWERS			SOM/2TAN	£512.76	£548.80	£610.76
Width:- 600mm	Depth:- 570mm	Height: 1470mm	Requires 1 x 355 x 595 & 1 x 283 x 595.			

Mid Height Housing 1250H

1250H midi units are supplied with 3 x adjustable shelves, 12 x shelf pins, 2 x Hettich soft close hinges and quick release plates and 4 x 150mm adjustable legs. This unit can also be made to accommodate a 900mm to 1200mm high larder fridge or freezer, just add a note mentioning the appliance and we won't put shelves or a back in the cabinet. The cabinet has 18mm rear panels and a service recess of 52mm

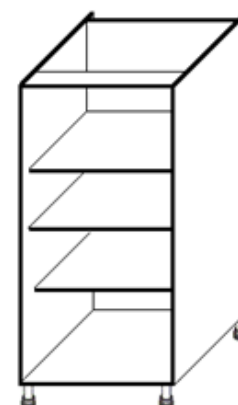

DESCRIPTION			CODE	WH	WG	WG2
600 MIDI UNIT 1250H (ALSO FRIDGE MIDI)			600MUB	£260.44	£311.52	£329.08
Width:- 600mm	Depth:- 570mm	Height: 1470mm	Requires 1 x 125 x 595			

1000mm Wide Wine Racks

All 1000mm wide wine racks can be made 150mm or 300mm high. 150mm high wine racks can accommodate 9 wine bottles. 300mm high wine racks can accommodate 18 bottles. 1000 wide wine racks are 300mm deep, supplied with wall hanging brackets. 1000mm wide wine racks are normally used above American fridge freezers.

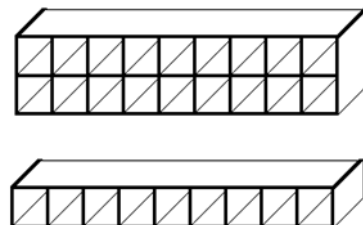

DESCRIPTION			CODE	WH	WG	WG2
1000H x 300H BOX STYLE WINE RACK UNIT			100BWR300	£267.72	£294.32	£334.68
Width: 1000mm	Depth:- 300mm	Height:- 300mm	Requires no facia (open unit)			
1000H x 150H BOX STYLE WINE RACK UNIT			100BWR150	£267.72	£294.32	£334.68
Width: 1000mm	Depth:- 300mm	Height:- 150mm	Requires no facia (open unit)			

Base & Wall Wine Racks 720mm High

All 720H wine racks can be made 150mm or 300mm wide. 150mm wine racks can accommodate 6 wine bottles. 300mm wine racks can accommodate 12 bottles. Both Base and wall wine racks are 300mm deep. Base wine racks are supplied with 2 x 150mm adjustable cabinet legs, wall wine racks are supplied with wall hanging brackets.

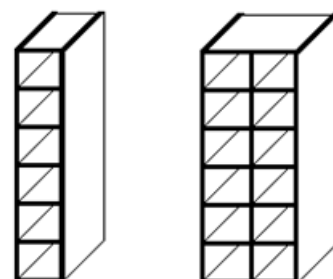

DESCRIPTION			STOCK CODE	WH	WG	WG2
150 BASE BOX STYLE 720H WINE RACK UNIT			150BWR	£246.40	£260.52	£282.00
Width:- 150mm	Depth:- 300mm	Height:- 720mm	Requires no facia (open unit)			
150 WALL BOX STYLE 720H WINE RACK UNIT			150WWR	£248.80	£263.24	£285.16
Width:- 150mm	Depth:- 300mm	Height:- 720mm	Requires no facia (open unit)			
300 BASE BOX STYLE 720H WINE RACK UNIT			300BWR	£256.28	£276.16	£306.40
Width:- 300mm	Depth:- 300mm	Height:- 720mm	Requires no facia (open unit)			
300 WALL BOX STYLE 720H WINE RACK UNIT			300WWR	£257.88	£277.64	£307.64
Width:- 300mm	Depth:- 300mm	Height:- 720mm	Requires no facia (open unit)			

Tall Wall Wine Racks 900mm High

All 900H wine racks can be made 150mm or 300mm wide. 150mm wine racks can accommodate 6 wine bottles. 300mm wine racks can accommodate 12 bottles. Both Base and wall wine racks are 300mm deep. Base wine racks are supplied with 2 x 150mm adjustable cabinet legs, wall wine racks are supplied with wall hanging brackets.

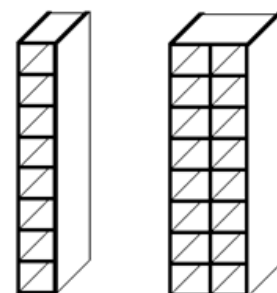

DESCRIPTION			CODE	WH	WG	WG2
150 BOX STYLE 1970H WINE RACK UNIT			150SLWR	£287.72	£326.04	£384.20
Width: - 150mm	Depth:- 300mm	Height: 1970mm	Requires no facia (open unit)			
150 TALL BOX STYLRL 2150H WINE RACK UNIT			150TLWR	£294.48	£336.72	£400.88
Width: - 150mm	Depth:- 300mm	Height: 2150mm	Requires no facia (open unit)			

Base & Wall Chrome Wine Racks 720mm

All 720H chrome wine racks can be made 150mm or 300mm wide. 150mm chrome wine racks can accommodate 5 wine bottles. 300mm chrome wine racks can accommodate 15 bottles. Both Base and wall wine racks are 300mm deep. Base wine racks are supplied with 2 x 150mm adjustable cabinet legs, wall wine racks are supplied with wall hanging brackets.

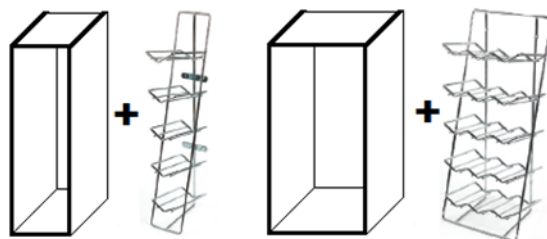

DESCRIPTION			CODE	WH	WG	WG2
150 CHROME BASE WINE RACK UNIT			150CBWR	£135.76	£144.40	£157.56
Width: - 150mm	Depth:- 300mm	Height:- 720mm	Requires no fascia (open unit)			
150 CHROME WALL WINE RACK UNIT			150CWWR	£137.64	£146.28	£159.44
Width: - 150mm	Depth:- 300mm	Height:- 720mm	Requires no fascia (open unit)			
300 CHROME BASE WINE RACK UNIT			300CBWR	£156.16	£167.72	£185.24
Width: - 300mm	Depth:- 300mm	Height:- 720mm	Requires no fascia (open unit)			
300 CHROME WALL WINE RACK UNIT			300CWWR	£158.04	£169.40	£187.12
Width: - 300mm	Depth:- 300mm	Height:- 720mm	Requires no fascia (open unit)			

Larder Units To Suit Pull Out Wirework

Larder units to suit pull out wirework are not supplied with the wirework system and must be ordered separately, 4 x 150mm adjustable legs are included. The pull out system can be installed at any time during the kitchen installation and will be packaged separately. 2150H tall larder pull outs are supplied with 4 x 18mm thick packers; these must be fitted to the top(x2) & bottom(x2) of the cabinet prior to installing the mechanism. All pull out larder units have a 32mm service recess and 18mm solid back panels For available wirework options please see page 105.



DESCRIPTION			CODE	WH	WG	WG2
300 LARDER UNIT TO SUIT PULL OUT 1970H			300SPL	£256.15	£309.62	£391.68
Width:- 300mm	Depth:- 570mm	Height: 1970mm	Requires 1 x 715 x 295 & 1 x 1245 x 295			
300 LARDER UNIT TO SUIT PULL OUT FULL HEIGHT DOOR			FHD300SPL	£256.15	£309.62	£391.68
Width:- 300mm	Depth:- 570mm	Height: 1970mm	Requires 1 x 1965 x 295			
300 TALL LARDER UNIT TO SUIT PULL OUT 2150H			300TPL	£262.68	£320.28	£407.78
Width:- 300mm	Depth:- 570mm	Height: 2150mm	Requires 1 x 895 x 295 & 1 x 1245 x 295			
400 LARDER UNIT TO SUIT PULL OUT 1970H			400SPL	£269.16	£330.56	£423.40
Width:- 300mm	Depth:- 570mm	Height: 1970mm	Requires 1 x 715 x 395 & 1 x 1245 x 395			
400 LARDER UNIT TO SUIT PULL OUT FULL HEIGHT DOOR			FHD400SPL	£269.16	£330.56	£423.40
Width:- 300mm	Depth:- 570mm	Height: 1970mm	Requires 1 x 1965 x 395			
400 LARDER UNIT TO SUIT PULL OUT 2150H			400TPL	£276.20	£341.72	£441.16
Width:- 300mm	Depth:- 570mm	Height: 2150mm	Requires 1 x 895 x 395 & 1 x 1245 x 395			

Larder Units To Suit Pantry Wirework

Larder units to suit swing out pantry systems are not supplied with the wirework system and must be ordered separately, 4 x 150mm adjustable legs & 4 x Hettich soft close 165 degree hinges and quick release plates are included. The pull out system can be installed at any time during the kitchen installation and will be packaged separately. Unlike a normal larder pull out, the cabinets are hinged and the wirework slides out as the door is opening. This means the pull out system is not supporting the weight of the door(s), allowing more weight allowance in the baskets. 2150H tall larder pull outs are supplied with 4 x 18mm thick packers; these must be fitted to the top(x2) & bottom(x2) of the cabinet prior to installing the mechanism. All Pegasus pull out larder units have a 32mm service recess and 18mm solid back panels **IMPORTANT:- THIS SYSTEM REQUIRES 100MM FOR THE DOOR TO OPEN, PAST THE SIDE OF THE UNIT ON THE HINGE SIDE, NOT RECOMMENDED TO BE INSTALLED NEXT TO WALLS OR TIGHT SPACES.** For available wirework options please see page 106.



DESCRIPTION			CODE	WH	WG	WG2
500 LARDER UNIT TO SUIT PANTRY 1970H			500SPL	£887.32	£942.48	£1026.24
Width:- 500mm	Depth:- 570mm	Height: 1970mm	Requires 1 x 715 x 495 & 1 x 1245 x 495			
500 LARDER UNIT TO SUIT PANTRY FULL HEIGHT DOOR			FHD500SPL	£887.32	£942.48	£1026.24
Width:- 500mm	Depth:- 570mm	Height: 1970mm	Requires 1 x 1965 x 495			
500 LARDER UNIT TO SUIT PANTRY 2150H			500TPL	£894.84	£954.44	£1044.88
Width:- 500mm	Depth:- 570mm	Height: 2150mm	Requires 1 x 895 x 495 & 1 x 1245 x 495			
600 LARDER UNIT TO SUIT PANTRY 1970H			600SPL	£915.76	£975.48	£1066.20
Width:- 600mm	Depth:- 570mm	Height: 1970mm	Requires 1 x 715 x 595 & 1 x 1245 x 595			
600 LARDER UNIT TO SUIT PANTRY FULL HEIGHT DOOR			FHD600SPL	£915.76	£975.48	£1066.20
Width:- 600mm	Depth:- 570mm	Height: 1970mm	Requires 1 x 1965 x 595			
600 LARDER UNIT TO SUIT PANTRY 2150H			600TPL	£955.28	£1038.12	£1163.88
Width:- 600mm	Depth:- 570mm	Height: 2150mm	Requires 1 x 895 x 595 & 1 x 1245 x 595			

Custom Dresser & Boiler Housing Units

CUSTOM BOILER & DRESSER UNITS	CODE	WH	WG	WG2
500 STANDARD BOILER/DRESSER UNIT	500SBD	£393.32	£425.84	£475.24
500 STANDARD OPEN BOTTOM DRESSER	500SOD	£327.48	£360.00	£409.40
500 STANDARD BI-FOLD OPEN DRESSER	500BFOD	£487.80	£520.32	£569.48
500 TALL BOILER/DRESSER UNIT	500TDU	£398.28	£433.68	£487.44
500 TALL OPEN BOTTOM DRESSER	500TOD	£332.44	£367.84	£422.24
600 STANDARD BOILER/DRESSER UNIT	600SBD	£401.40	£438.64	£495.16
600 STANDARD OPEN BOTTOM DRESSER	600SOD	£355.28	£392.52	£449.04
600 STANDARD BI-FOLD OPEN BOTTOM DRESSER	600BFOD	£515.60	£552.84	£609.36
600 TALL BOILER/DRESSER UNIT	600TDU	£406.84	£447.28	£508.68
500 STANDARD TAMBOUR UNIT	500TBU	£755.80	£784.52	£828.12
600 STANDARD TAMBOUR UNIT	600TBU	£882.56	£915.24	£964.84
500 TALL TAMBOUR UNIT WITH DRAWER	500TTU/TAN	£838.12	£871.68	£922.68
600 TALL TAMBOUR UNIT WITH DRAWER	600TTU/TAN	£965.92	£1004.04	£1062.00

Please note:- Before ordering the above units please speak to a member of our sales team. The above cabinets are not standard and will require further information regarding dimensions etc. A technical drawing will be provided for your approval before we manufacture any of the above cabinets.

Matching MFC Panels

Matching MFC panels are manufactured using the same material as your cabinets, the panels can be edged in 1mm or 2mm PVC edging. MFC panels can be used instead of matching accessories from your chosen door range, giving a contrast from your fascias. You can also choose panels that match your worktops for that framed in look. Matching MFC panels are also used as matching accessories for our PIATTO range.

No	MELAMINE PANELS	CODE	WH	WG	WG2
1	2650 X 150MM KITCHEN PLINTH	PLINTH	£34.40	£40.48	£49.72
2	2650 X 100MM BEDROOM PLINTH	BPLINTH	£34.40	£40.48	£49.72
3	900 X 350MM TALL WALL END PANEL	TWPAN	£32.08	£36.76	£43.92
4	720 X 350MM WALL END PANEL	WPAN	£30.52	£34.32	£40.08
5	760 X 350MM WALL END PANEL	WPAN2	£30.52	£34.32	£40.08
6	950 X 650MM BASE END PANEL	BPAN	£40.12	£49.56	£63.84
7	2400 X 650MM LARDER END PANEL	LEPAN	£64.56	£88.28	£124.28
8	2400 X 700MM LARDER END PANEL	LEPAN2	£64.56	£88.28	£124.28
9	1200 x 300MM FLYSHELF PANEL	FLY1	£33.88	£39.64	£48.44
10	320 X 2400MM FLYSHELF PANEL	FLY2	£43.76	£55.32	£72.84
11	950 X 1200MM BREAKFAST BAR PANEL	BBAR1	£53.64	£70.96	£97.28
12	950 X 2400M BREAKFAST BAR PANEL	BBAR2	£83.28	£117.95	£174.56
13	950 X 610MM BREAKFAST BAR SIDE PANEL	BBS	£39.08	£47.88	£61.28

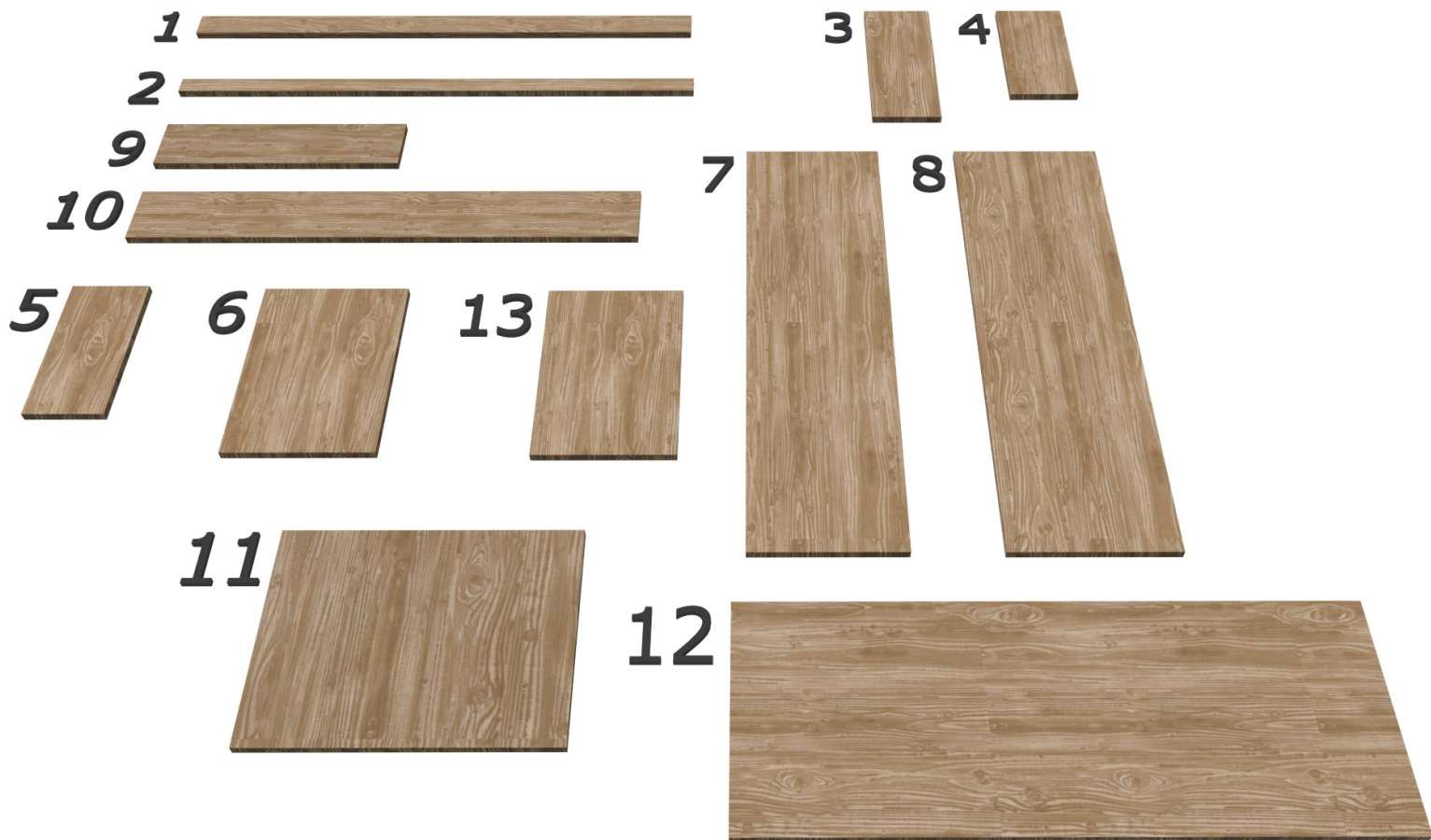

Base & Wall Cabinets

Standard Height Wall Units & Larder Units.

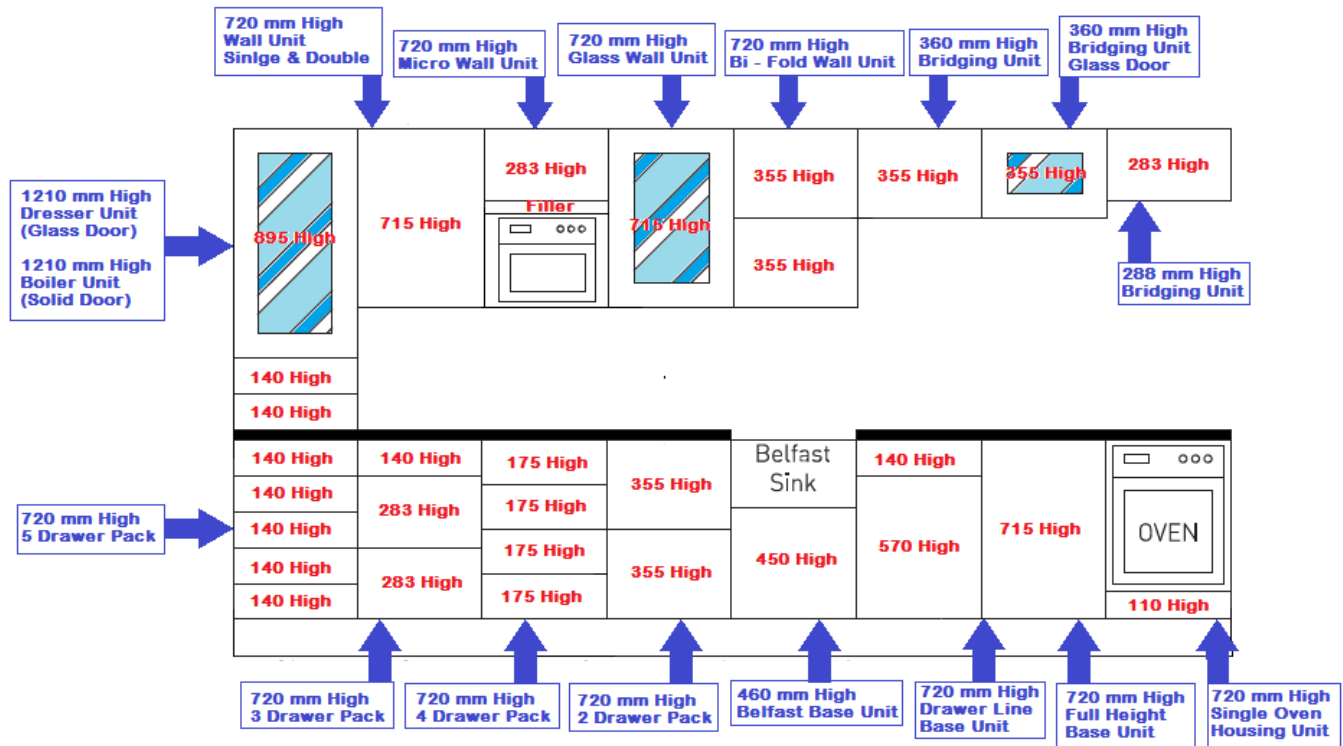

HEIGHT & TYPE OF CABINET.
COMBINATION AND HEIGHT OF CABINET FACIAS

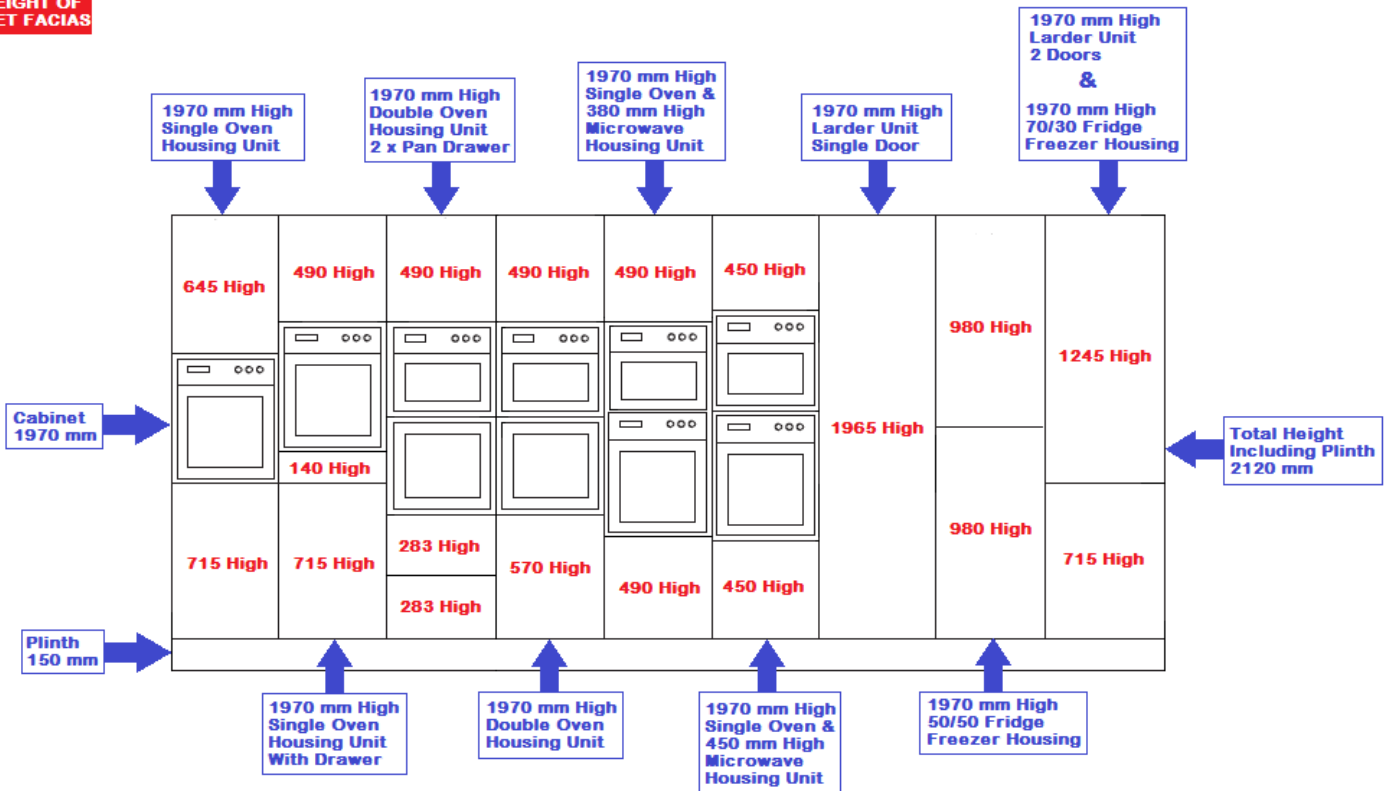

The above cabinets are available in various widths, please see our price list for full options. Not all cabinets are available in every range (check doors sizes available for each range). 5 Drawer packs are not available in any J-Profile door range.

Tall Height Wall Units & Larder Units

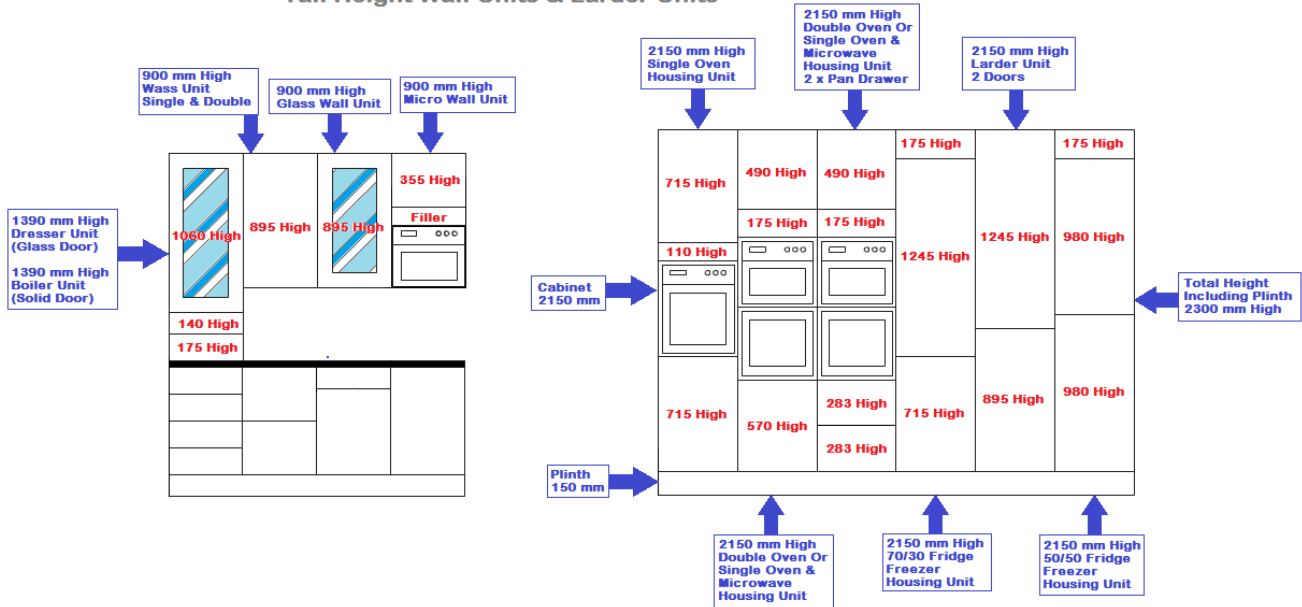

1250 mm High Midi Height Units & Housings

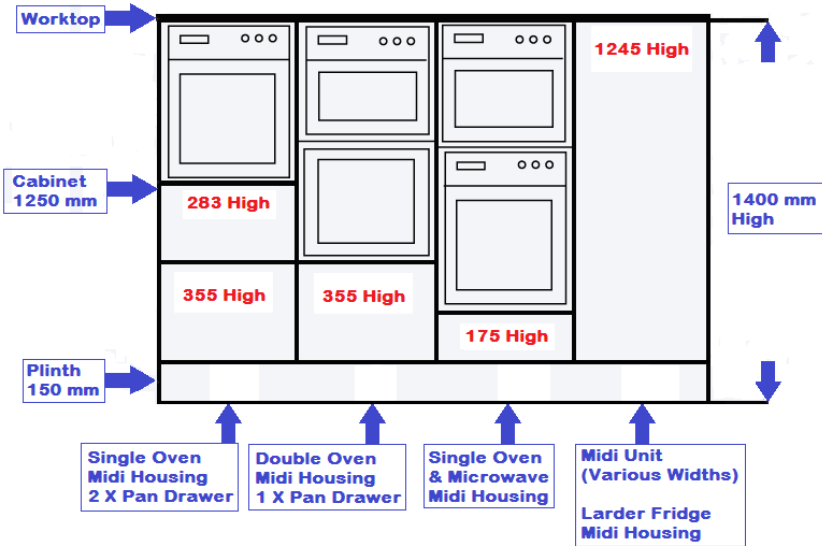

1470 mm High Midi Units & Housings

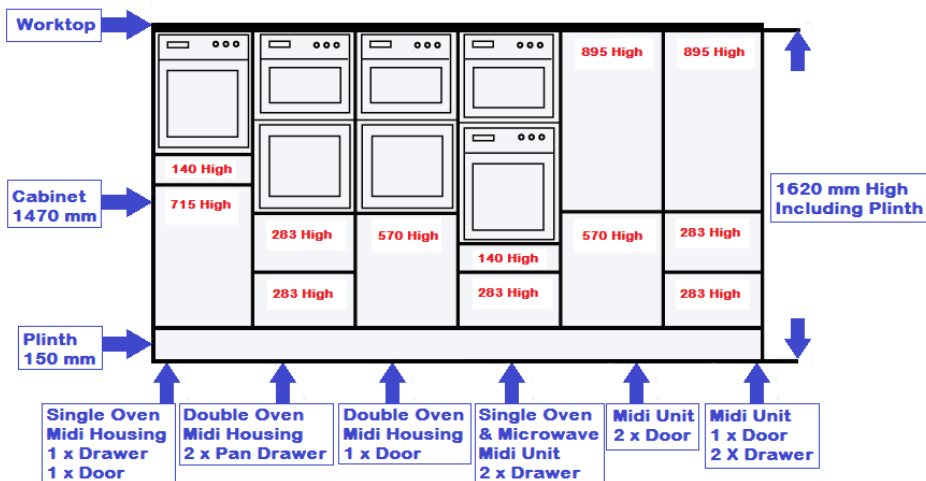

Curved Base & Wall Units

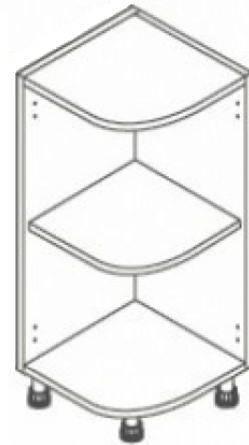

Curved Base - 720 mm High
Requires 715 x 300 curved door

Curved Wall - 720 mm High
Requires 715 x 300 curved door

Curved Tall Wall - 900 mm High
Requires 895 x 300 curved door

Curved Base Units Can Be Used With a 260mm Base

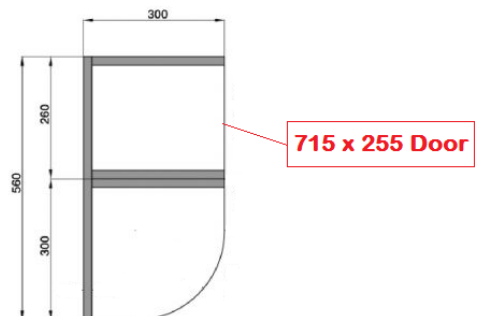

Integro Cabinets - True Handleless

Our INTEGRO cabinets have an aluminium handle profile built into them. We manufacture your cabinets in a choice of 30 colours. Custom sized cabinets are not available in INTEGRO, this is due to the handle profile limiting what we can, and can't do with the cabinets. **Look out for Integro cabinets on selected ranges.**

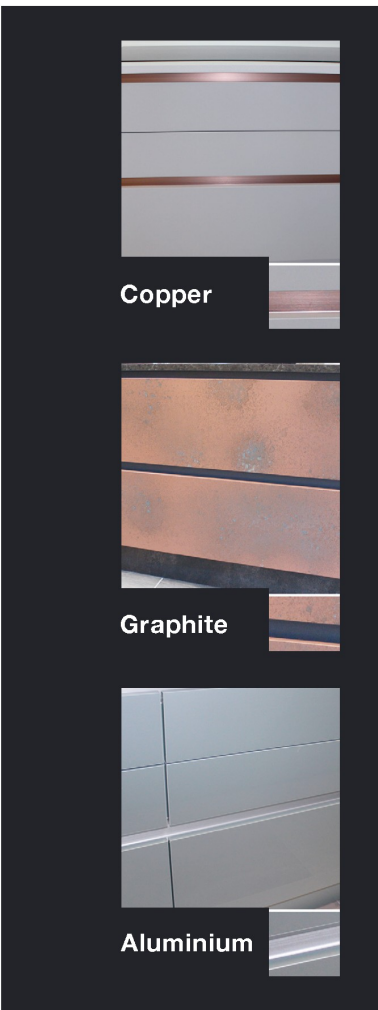

WALL UNIT PROFILE
Used for wall cabinet doors.



TOP PROFILE
Used for doors and top drawers.



MID PROFILE
Used for mid and bottom drawers.



VERTICAL PROFILE INTERMEDIATE
Used between two tall units



SPACER FOR APPLIANCE
Used with Vertical Profile



EXTERNAL CORNER JOINT - TOP
Used to create a seamless design, combine with external corner post.



AVAILABLE IN 3 FINISHES WALL CABINET PROFILE ALUMINIUM ONLY



Aluminium

Graphite

Copper

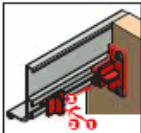

Quick Fix Brackets

Screw mounted



Vertical Profile - Lateral

Used with one tall unit



Internal Corner Joint - Top

Combine with internal corner post



Internal Corner Joint - Mid

Combine with internal corner post



End Cap - Top

Used to finish top profiles



End Cap - Mid

Used to finish mid profiles



Joint Section - Top

Used to join top profiles together

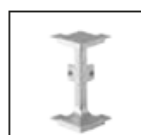

External Corner Joint - Mid

Combine with external corner post

INTEGRO CABINET RANGE, BASE UNITS & STANDARD HEIGHT WALL & LARDER CABINETS ALL AVAILABLE CABINET WIDTHS & DOOR HEIGHT COMBINATIONS

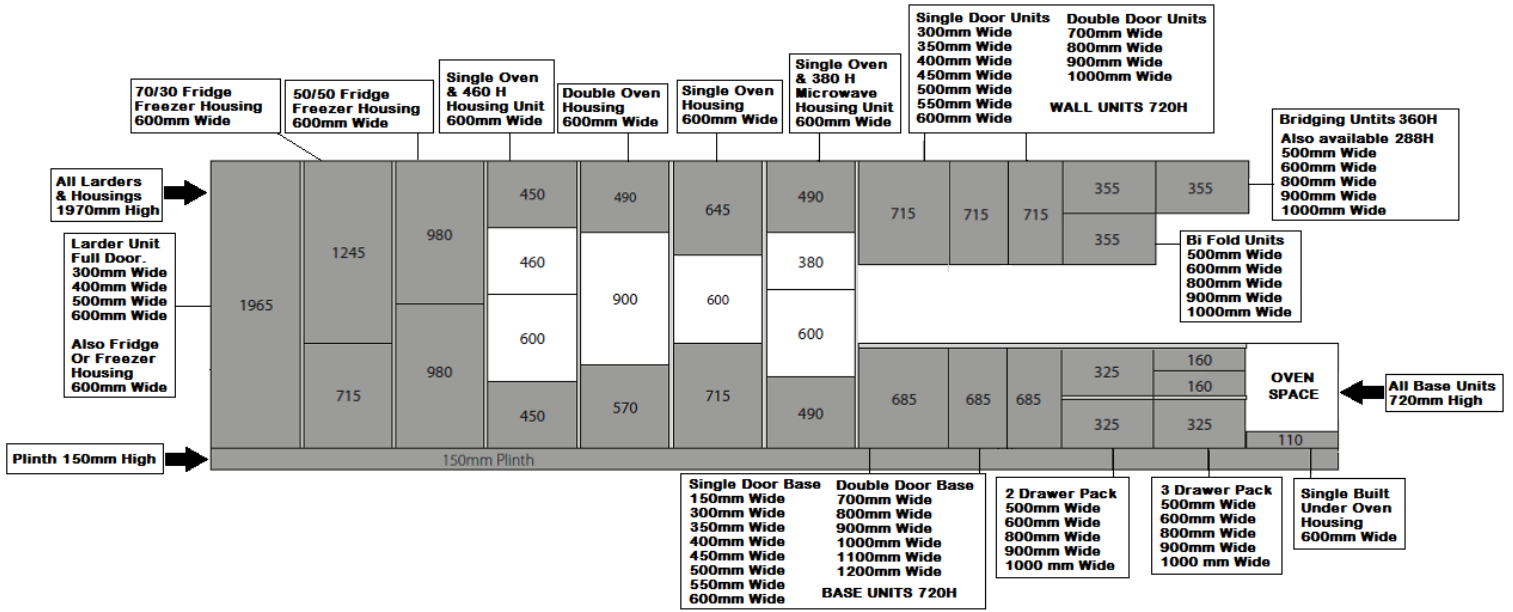

INTEGRO CABINET RANGE FOR TALL WALL AND TALL HEIGHT LARDERS & HOUSINGS ALL AVAILABLE CABINET WIDTHS & DOOR HEIGHT COMBINATIONS

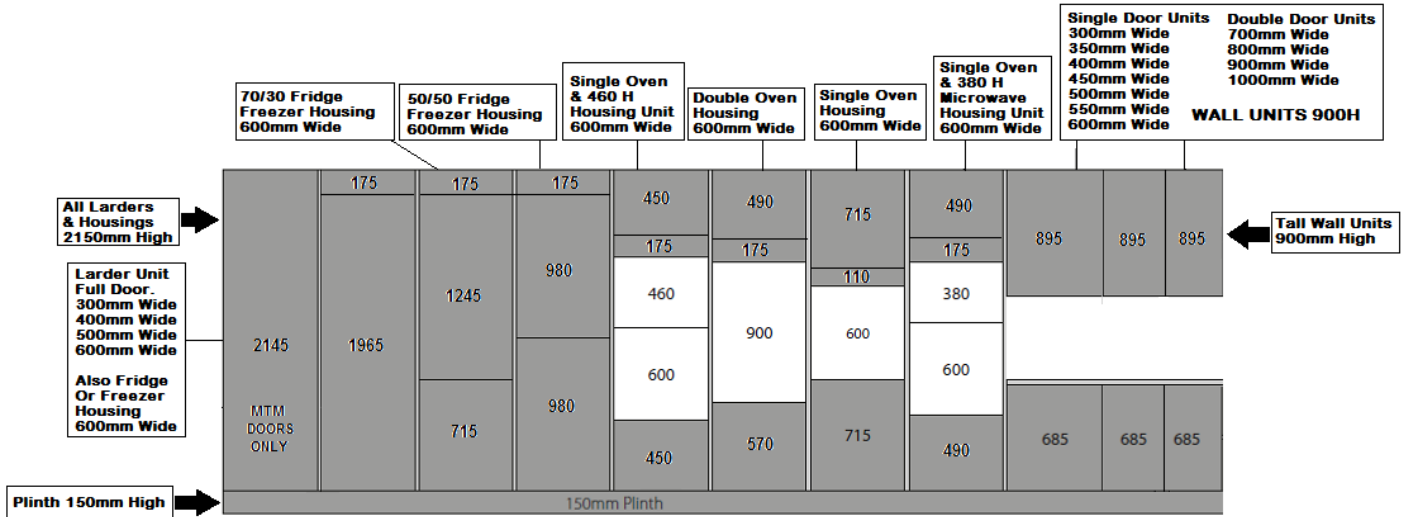

All Corner Base Units Supplied With Internal Corner Section For Top Handle Profile

BASE CORNER CABINETS

Base Corner Cabinets
800 mm Corner (395 Wide Door)
900 mm Corner (445 Wide Door)
1000 mm Corner (495 Wide Door)
1100 mm Corner (555 Wide Door)
1100 mm Corner RH (595 Wide Door)
1100 mm Corner LH (595 Wide Door)

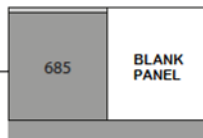

910mm X 910mm L-Shape Corner Requires 2 X 715x313mm Doors DELIVERED FLAT PACKED

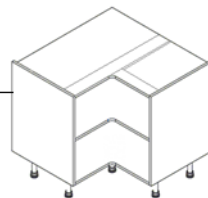

NOTE:- 1100 corners with a 595 wide door are handed. Image shown is L/H.

WALL CORNER CABINET

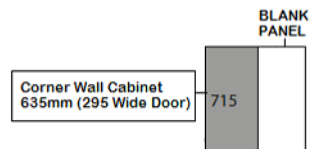



Base Cabinets & Profiles

DIMENSIONS

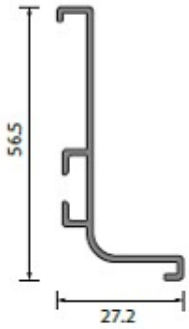

FITTED DETAIL

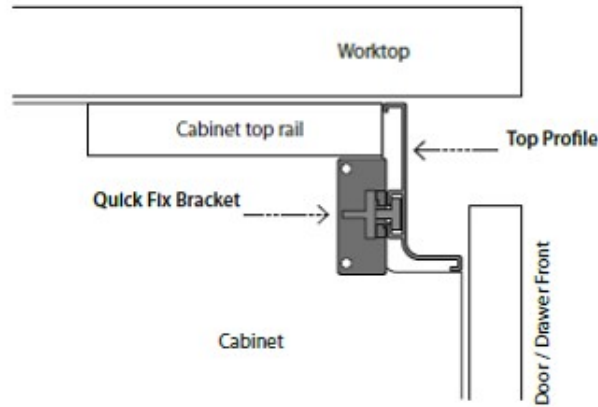

CABINET ROUTING

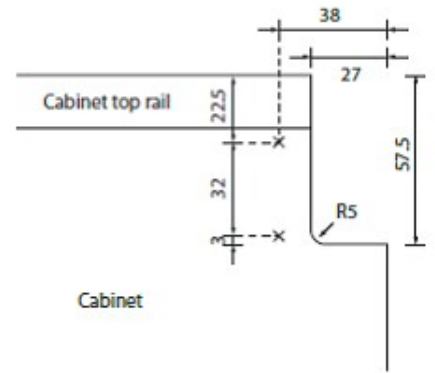

CABINET DIMENSIONS

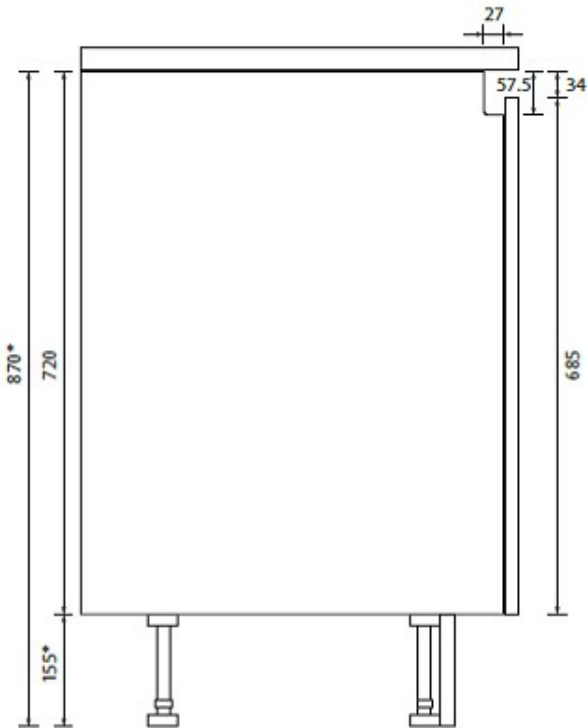

* nb. If installing an intergrated appliance in the kitchen please add a minimum of 5mm to allow for easy installation of appliance.

1. Top Profile
2. Internal Corner Joint - Top
3. External Corner Joint - Top
4. Quick Fix Bracket
5. End Cap - Top

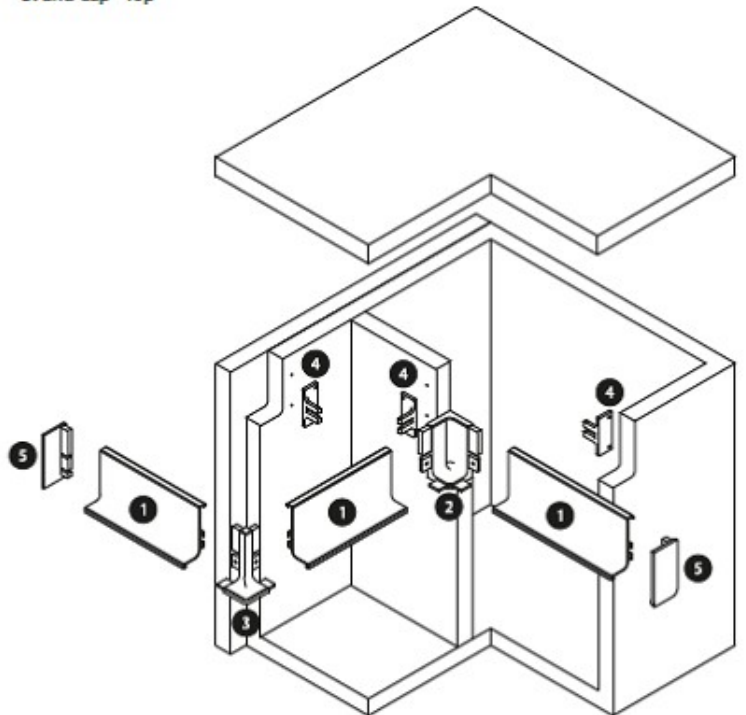

Mid Profile



- Used for mid and bottom drawers.
- Can be cut to size using a circular chop saw.
- Secured to cabinets with Quick Fix Brackets.
- Profiles can be finished off with End Caps before fitting.
- Mid profiles can be linked at corners using Internal and External Corner Joints.

Dimensions

4100 x 73 x 26mm

Accessories available

Quick Fix Brackets
End Cap - Mid
Internal Corner Joint - Mid
External Corner Joint - Mid

DIMENSIONS

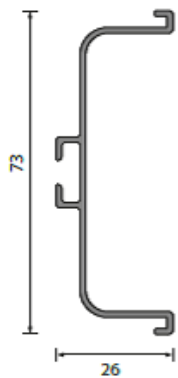

FITTED DETAIL

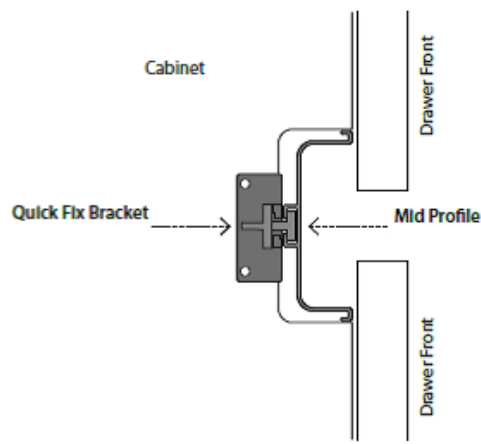

CABINET ROUTING

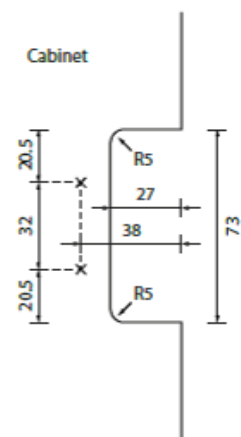

CABINET DIMENSIONS

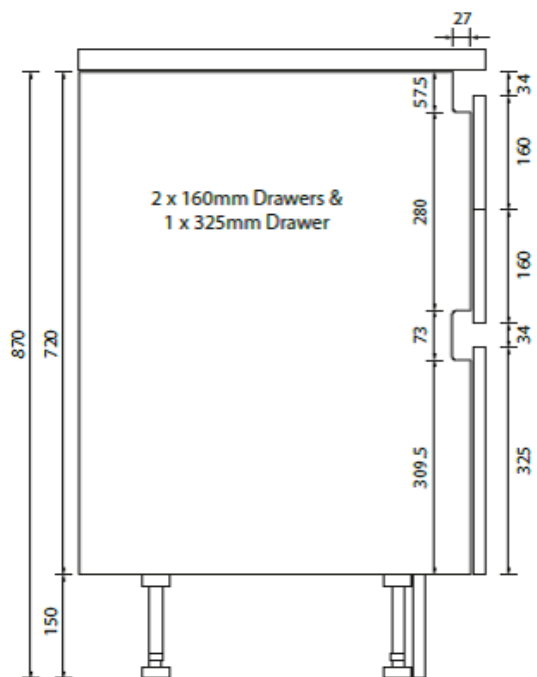
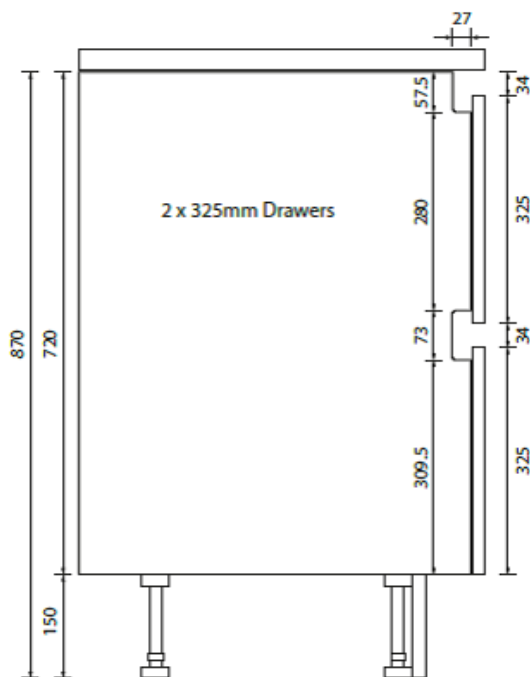

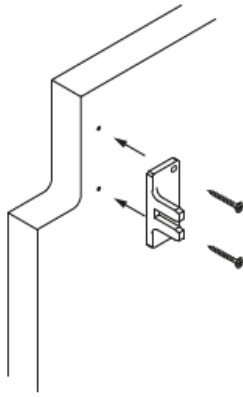

Step 1.
Attach quick fix brackets to routed cabinet gables using screws.

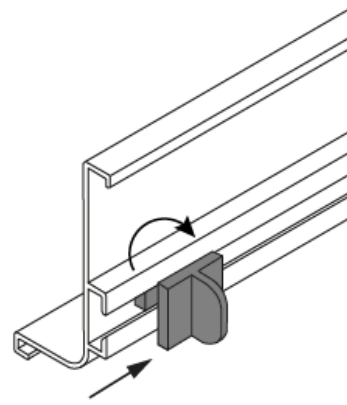

Step 2.
Slide the connectors into the back of the profile and turn 90 degrees.

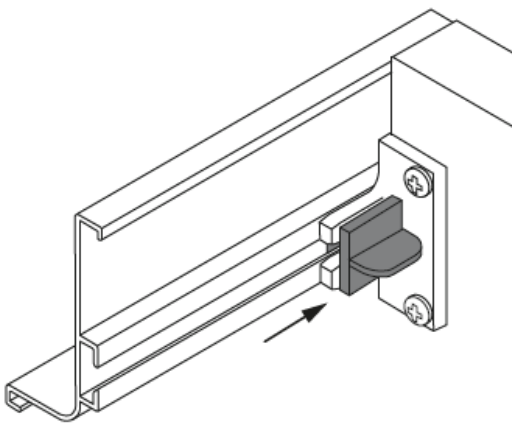

Step 3.
Apply profile to routed cabinet and push connectors into brackets to secure the profile to the cabinet.

Internal Corner Joint - Top

- Used to connect two top profiles at an internal corner, to be used together with an internal corner post.
- Secured to the top profile using two screws (supplied).

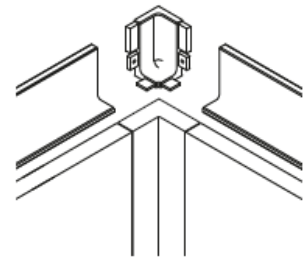
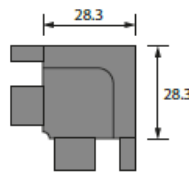

External Corner Joint - Top

- Used to connect two top profiles running around an external corner or an island unit, to be used together with an external corner post.
- Secured to the top profile using two screws (supplied).

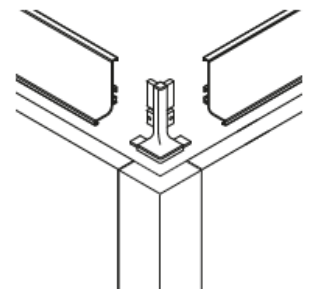
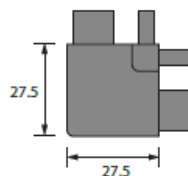

Internal Corner Joint - Mid

- Used to connect two mid profiles at an internal corner, to be used together with internal corner posts.
- Secured to the mid profile using two screws (supplied).

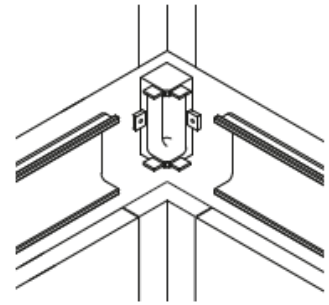
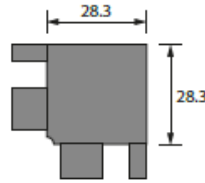

External Corner Joint - Mid

- Used to connect two mid profiles running around an external corner or an island unit, to be used together with external corner posts.
- Secured to the mid profile using two screws (supplied).

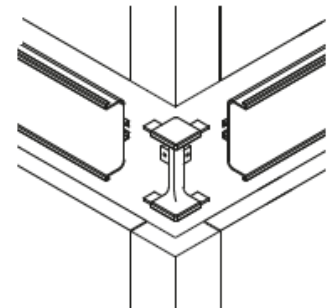
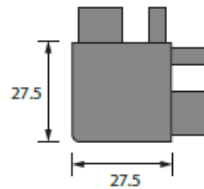

End Caps - Top

- Used at the end of a top profile for example against a wall, end panel or next to appliances such as under mounted oven.
- Secured to the top profile using a grub screw (supplied). (Grub screw secured with Allen key)
- When using end caps, a 2mm spacing must be taken into account when cutting down the trim.

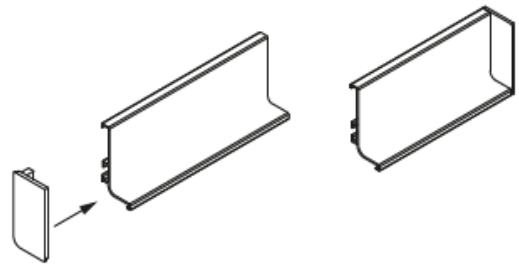
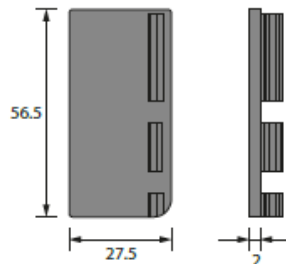

End Caps - Mid

- Used at the end of a mid profile for example against a wall, end panel or next to appliances such as under mounted oven.
- Secured to the mid profile using a grub screw (supplied). (Grub screw secured with Allen key)
- When using end caps, a 2mm spacing must be taken into account when cutting down the trim.

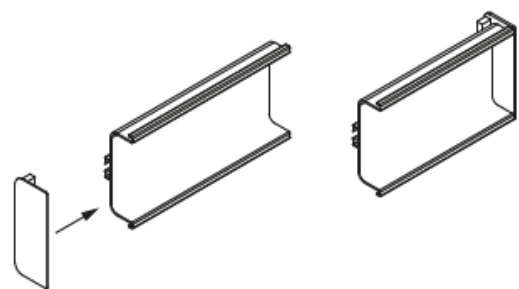

Integro Base Cabinets



DIMENSIONS

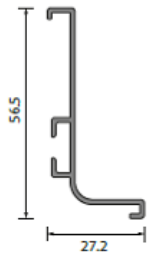

FITTED DETAIL

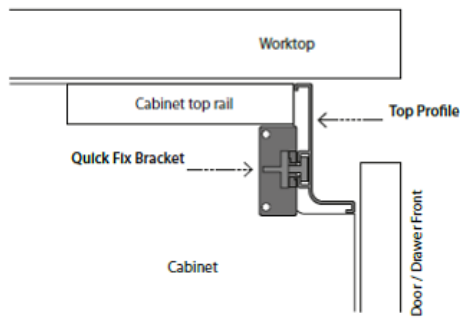

CABINET DIMENSIONS

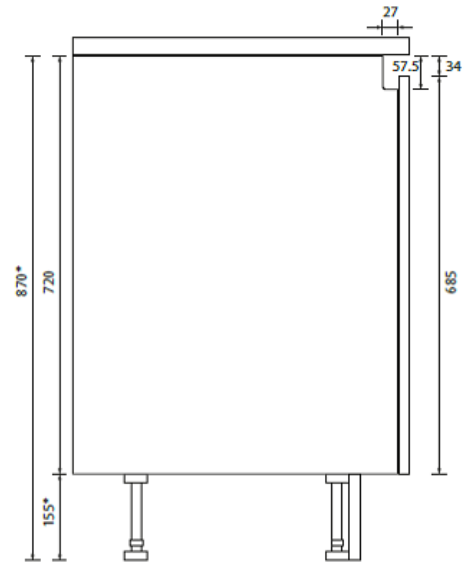

Base Cabinets & Profiles

All our INTEGRO base cabinets are supplied & priced complete with enough Top Profile & Quick Fix Brackets to fit into each unit.

Single Base Cabinets

BASE UNIT WIDTH	CODE	LIST PRICE
150mm HI LINE BASE UNIT INCLUDING RAIL & FIXINGS	IH/150BFH	£210.36
Requires 1 x 685mm high x 145 wide cabinet door		
300mm HI LINE BASE UNIT INCLUDING RAIL & FIXINGS	IH/300BFH	£222.36
Requires 1 x 685mm high x 295 wide cabinet door		
350mm HI LINE BASE UNIT INCLUDING RAIL & FIXINGS	IH/350BFH	£228.60
Requires 1 x 685mm high x 345 wide cabinet door		
400mm HI LINE BASE UNIT INCLUDING RAIL & FIXINGS	IH/400BFH	£235.52
Requires 1 x 685mm high x 395 wide cabinet door		
450mm HI LINE BASE UNIT INCLUDING RAIL & FIXINGS	IH/450BFH	£242.44
Requires 1 x 685mm high x 445 wide cabinet door		
500mm HI LINE BASE UNIT INCLUDING RAIL & FIXINGS	IH/500BFH	£248.68
Requires 1 x 685mm high x 495 wide cabinet door		
550mm HI LINE BASE UNIT INCLUDING RAIL & FIXINGS	IH/550BFH	£255.60
Requires 1 x 685mm high x 545 wide cabinet door		
600mm HI LINE BASE UNIT INCLUDING RAIL & FIXINGS	IH/600BFH	£261.84
Requires 1 x 685mm high x 595 wide cabinet door		

Double Base Cabinets

BASE UNIT WIDTH	CODE	LIST PRICE
700mm HI LINE BASE UNIT INCLUDING RAIL & FIXINGS	IH/700BFH	£293.96
Requires 2 x 685mm high x 345 wide cabinet doors		
800mm HI LINE BASE UNIT INCLUDING RAIL & FIXINGS	IH/800BFH	£293.96
Requires 2 x 685mm high x 395 wide cabinet doors		
900mm HI LINE BASE UNIT INCLUDING RAIL & FIXINGS	IH/900BFH	£305.96
Requires 2 x 685mm high x 445 wide cabinet doors		
1000mm HI LINE BASE UNIT INCLUDING RAIL & FIXINGS	IH/100BFH	£317.96
Requires 2 x 685mm high x 495 wide cabinet doors		
1100mm HI LINE BASE UNIT INCLUDING RAIL & FIXINGS	IH/110BFH	£329.96
Requires 2 x 685mm high x 545 wide cabinet doors		
1200mm HI LINE BASE UNIT INCLUDING RAIL & FIXINGS	IH/120BFH	£341.96
Requires 2 x 685mm high x 595 wide cabinet doors		

Pull Out Base Cabinets

IMPORTANT

Integro 150mm & 300mm base pull out cabinets are supplied WITHOUT THE PULL OUT WIREWORK. This can be ordered separately in a number of various options, see page 103. Your chosen wirework will be boxed separately and we recommend installing any wirework before installing the cabinet into the kitchen. Pull out bins are included in the price of the cabinet, the bins will be pre installed into each unit.

BASE UNIT WIDTH	CODE	LIST PRICE
150mm BASE TO SUIT PULL OUT UNIT INCLUDING RAIL & FIXINGS	IH/150BFH	£360.52
Requires 1 x 685mm high x 145 wide cabinet door		
300mm BASE TO SUIT PULL OUT UNIT INCLUDING RAIL & FIXINGS	IH/300BPO	£380.52
Requires 1 x 685mm high x 295 wide cabinet door		
400mm PULL OUT BIN UNIT INCLUDING RAIL & FIXINGS	IH/400PPB	£858.06
Requires 1 x 685mm high x 395 wide cabinet door		
500mm PULL OUT BIN UNIT INCLUDING RAIL & FIXINGS	IH/500PPB	£940.68
Requires 1 x 685mm high x 495 wide cabinet door		
600mm PULL OUT BIN UNIT INCLUDING RAIL & FIXINGS	IH/600PPB	£1124.58
Requires 1 x 685mm high x 595 wide cabinet door		

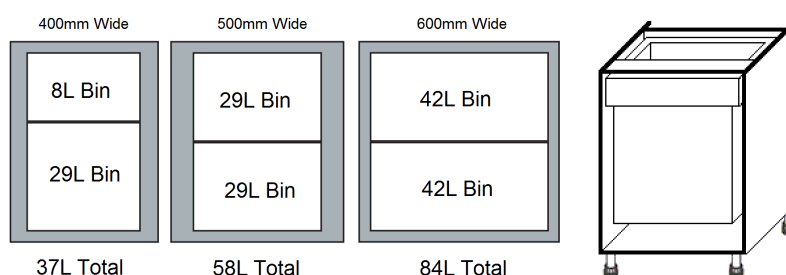

Drawer Base Cabinets

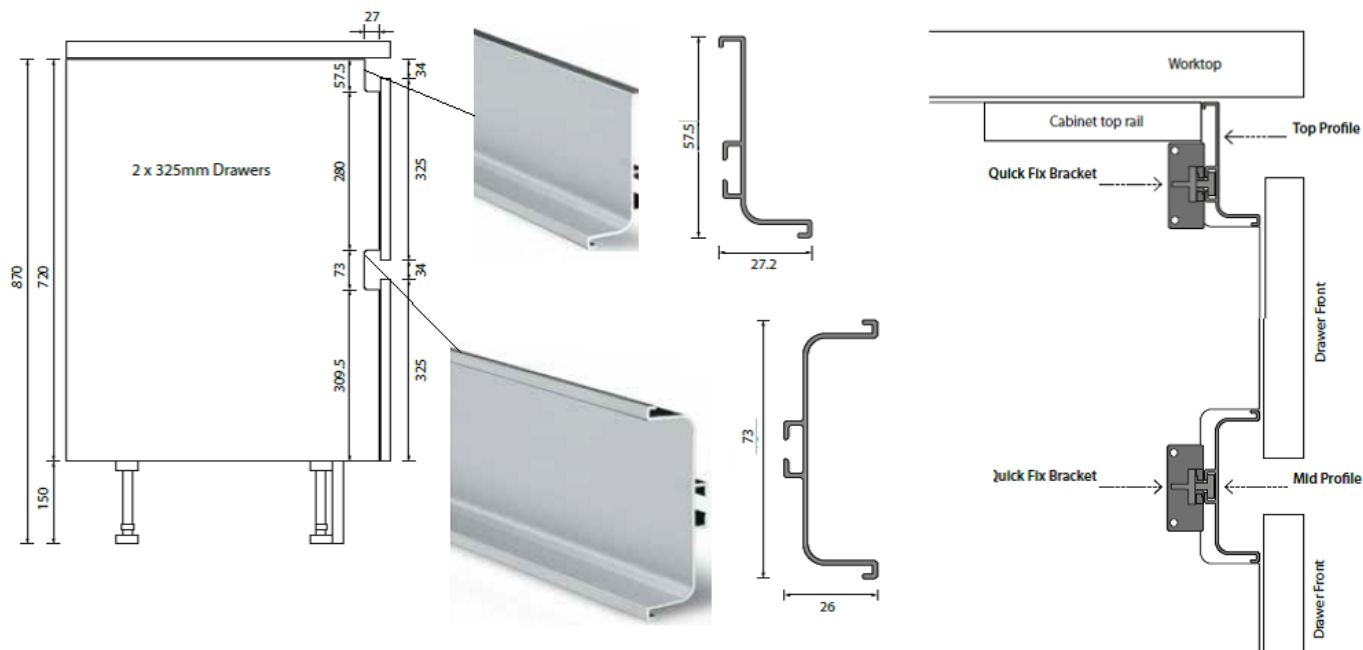

2 DRAWER UNIT WIDTH	CODE	LIST PRICE
500mm 2 DRAWER PACK UNIT INCLUDING RAILS & FITTINGS	IH/5002DP	£627.28
Requires 2 x 325mm high x 495 wide cabinet doors		
600mm 2 DRAWER PACK UNIT INCLUDING RAILS & FITTINGS	IH/6002DP	£640.88
Requires 2 x 325mm high x 595 wide cabinet doors		
800mm 2 DRAWER PACK UNIT INCLUDING RAILS & FITTINGS	IH/8002DP	£668.08
Requires 2 x 325mm high x 795 wide cabinet doors		
900mm 2 DRAWER PACK UNIT INCLUDING RAILS & FITTINGS	IH/9002DP	£681.68
Requires 2 x 325mm high x 895 wide cabinet doors		
1000mm 2 DRAWER PACK UNIT INCLUDING RAILS & FITTINGS	IH/1002DP	£695.95
Requires 2 x 325mm high x 995 wide cabinet doors		

3 DRAWER UNIT WIDTH	CODE	LIST PRICE
500mm 2 DRAWER PACK UNIT INCLUDING RAILS & FITTINGS	IH/5003DP	£647.28
Requires 2 x 160 495 & 1 x 325mm high x 495 wide cabinet doors		
600mm 2 DRAWER PACK UNIT INCLUDING RAILS & FITTINGS	IH/6003DP	£660.88
Requires 2 x 160 595 & 1 x 325mm high x 595 wide cabinet doors		
800mm 2 DRAWER PACK UNIT INCLUDING RAILS & FITTINGS	IH/8003DP	£688.08
Requires 2 x 160 795 & 1 x 325mm high x 795 wide cabinet doors		
900mm 2 DRAWER PACK UNIT INCLUDING RAILS & FITTINGS	IH/9003DP	£701.68
Requires 2 x 160 895 & 1 x 325mm high x 895 wide cabinet doors		
1000mm 2 DRAWER PACK UNIT INCLUDING RAILS & FITTINGS	IH/1003DP	£715.95
Requires 2 x 160 995 & 1 x 325mm high x 995 wide cabinet doors		

Corner Base Cabinets

- 1 Top profile
- 2 Corner profile
- 3 Quick fix bracket

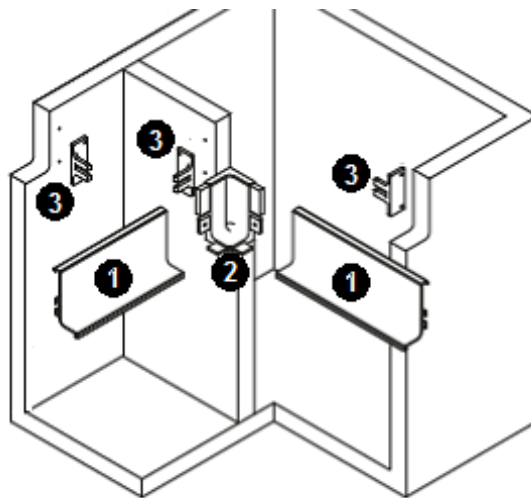

Integro corner cabinets are supplied with ALL components required, just add your required door size in your chosen range. An internal corner section is also supplied as shown in the diagram above. **Magic corners or wirework must be ordered separately, please see page 104**

CORNER UNIT WIDTH	CODE	LIST PRICE
800mm CORNER (400 DOOR) INCLUDING RAIL & FIXINGS	IH/800FHC	£384.80
Requires 1 x 685mm high x 395 wide cabinet door		
900mm CORNER (450 DOOR) INCLUDING RAIL & FIXINGS	IH/900FHC	£397.48
900mm CORNER TO SUIT MAGIC CORNER (450DOOR) INC RAIL & FITTINGS	IH/900FHMC	
Requires 1 x 685mm high x 445 wide cabinet door		
1000mm CORNER (500 DOOR) INCLUDING RAIL & FIXINGS	IH/100FHC	£409.52
1000mm CORNER TO SUIT MAGIC CORNER (500DOOR) INC RAIL & FITTINGS	IH/100FHMC	
Requires 1 x 685mm high x 496 wide cabinet door		
1100mm CORNER (550 DOOR) INCLUDING RAIL & FIXINGS	IH/110FHC/550D	£421.56
1100mm CORNER TO SUIT MAGIC CORNER (550DOOR) INC RAIL & FITTINGS	IH/110FHMC	
Requires 1 x 685mm high x 445 wide cabinet door		
1100mm CORNER (600 DOOR) LH INCLUDING RAIL & FIXINGS	IH/110FHC/LH	£422.68
1100mm CORNER TO SUIT MAGIC CORNER L/H (600DOOR) INC RAIL & FITTINGS	IH/110FHMC/L	£856.68
Requires 1 x 685mm high x 595 wide cabinet door		
1100mm CORNER (600 DOOR) RH INCLUDING RAIL & FIXINGS	IH/110FHC/RH	£422.68
1100mm CORNER TO SUIT MAGIC CORNER R/H (600DOOR) INC RAIL & FITTINGS	IH/100FHMC/R	£856.68
Requires 1 x 685mm high x 595 wide cabinet door		
910mm X 910mm L SHAPED CORNER INC RAIL & FITTINGS	IH/910FHC	£633.68
Requires 2 x 685mm high x 313 wide cabinet doors (cabinet supplied flat packed only)		

Integro Wall Cabinets

WALL UNIT PROFILE

Used for wall cabinet doors.

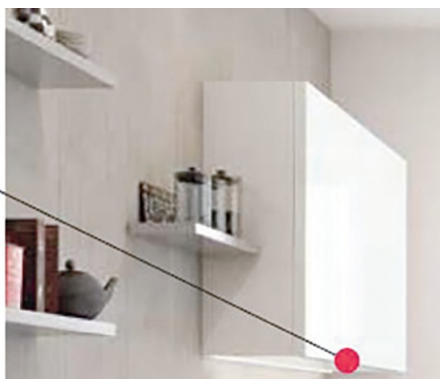

Integro wall cabinets are supplied fitted with an aluminium rail built into the bottom panel of the wall unit. This allows the cabinet door to be opened from a finger recess behind the door. **Wall unit rail is ONLY AVAILABLE IN ALUMINIUM FINISH.** When choosing copper or graphite rail system in the rest of your cabinets you have 2 options. Option 1 is to have the aluminium rail fitted, it is only visible when your cabinet door is open. Option 2 is to have the bottom panel in each cabinet raised by 20mm to allow a finger space at the bottom of each cabinet. **Pelmet cannot be fitted to integro wall cabinets**

Single Wall Cabinets 720H

WALL UNIT WIDTH	CODE	LIST PRICE
300mm STANDARD WALL UNIT	IH/300SWU	£197.60
Requires 1 x 715mm high x 295 wide cabinet door		
350mm STANDARD WALL UNIT	IH/350SWU	£204.52
Requires 1 x 715mm high x 345 wide cabinet door		
400mm STANDARD WALL UNIT	IH/400SWU	£209.93
Requires 1 x 715mm high x 395 wide cabinet door		
450mm STANDARD WALL UNIT	IH/450SWU	£217.68
Requires 1 x 715mm high x 445 wide cabinet door		
500mm STANDARD WALL UNIT	IH/500SWU	£224.60
Requires 1 x 715mm high x 495 wide cabinet door		
550mm STANDARD WALL UNIT	IH/550SWU	£231.48
Requires 1 x 715mm high x 545 wide cabinet door		
600mm STANDARD WALL UNIT	IH/600SWU	£238.40
Requires 1 x 715mm high x 595 wide cabinet door		

Double Wall Cabinets 720H

WALL UNIT WIDTH	CODE	LIST PRICE
700mm STANDARD WALL UNIT	IH/700SWU	£266.40
Requires 2 x 715mm high x 345 wide cabinet doors		
800mm STANDARD WALL UNIT	IH/800SWU	£282.40
Requires 2 x 715mm high x 395 wide cabinet doors		
900mm STANDARD WALL UNIT	IH/900SWU	£290.40
Requires 2 x 715mm high x 445 wide cabinet doors		
1000mm STANDARD WALL UNIT	IH/1000SWU	£298.40
Requires 2 x 715mm high x 495 wide cabinet doors		

Bi Fold Wall Cabinets 720H

Integro Bi fold wall cabinets are supplied complete with gas lift bi fold mechanism. Both side panels are pre drilled for easy installation of the mechanism. Bi fold wall units are supplied with 200mm deep shelves to accommodate the lifting arms when the doors are closed.

WALL UNIT WIDTH	CODE	LIST PRICE
500mm BI-FOLD GAS LIFT WALL UNIT	IH/500BFW	£381.68
Requires 2 x 355mm high x 495 wide cabinet doors		
600mm BI-FOLD GAS LIFT WALL UNIT	IH/600BFW	£394.60
Requires 2 x 355mm high x 595 wide cabinet doors		
800mm BI-FOLD GAS LIFT WALL UNIT	IH/800BFW	£420.56
Requires 2 x 355mm high x 795 wide cabinet doors		
900mm BI-FOLD GAS LIFT WALL UNIT	IH/900BFW	£433.08
Requires 2 x 355mm high x 895 wide cabinet doors		
1000mm BI-FOLD GAS LIFT WALL UNIT	IH/100BFW	£446.24
Requires 2 x 355mm high x 995 wide cabinet doors		

Bridging Cabinets 360H

BRIDGING UNIT WIDTH	CODE	LIST PRICE
500mm BRIDGING UNIT 360H	IH/500SBU	£187.44
Requires 1 x 355mm high x 495 wide cabinet door		
600mm BRIDGING UNIT 360H	IH/600SBU	£195.48
Requires 1 x 355mm high x 595 wide cabinet door		
800mm BRIDGING UNIT 360H	IH/800SBU	£215.52
Requires 1 x 355mm high x 795 wide cabinet door		
900mm BRIDGING UNIT 360H	IH/900SBU	£223.56
Requires 1 x 355mm high x 895 wide cabinet door		
1000mm BRIDGING UNIT 360H	IH/100SBU	£231.60
Requires 1 x 355mm high x 995 wide cabinet door		

Bridging Cabinets 288H

BRIDGING UNIT WIDTH	CODE	LIST PRICE
500mm BRIDGING UNIT 288H	IH/500STB	£187.44
Requires 1 x 283mm high x 495 wide cabinet door		
600mm BRIDGING UNIT 288H	IH/600STB	£195.48
Requires 1 x 283mm high x 595 wide cabinet door		
800mm BRIDGING UNIT 288H	IH/800STB	£215.52
Requires 1 x 283mm high x 795 wide cabinet door		
900mm BRIDGING UNIT 288H	IH/900STB	£223.56
Requires 1 x 283mm high x 895 wide cabinet door		
1000mm BRIDGING UNIT 288H	IH/100STB	£231.60
Requires 1 x 283mm high x 995 wide cabinet door		

Single Wall Units 900H

WALL UNIT WIDTH	CODE	LIST PRICE
300mm TALL WALL UNIT	IH/300TWU	£217.60
Requires 1 x 895mm high x 295 wide cabinet door		
350mm TALL WALL UNIT	IH/350TWU	£224.52
Requires 1 x 895mm high x 345 wide cabinet door		
400mm TALL WALL UNIT	IH/400TWU	£230.76
Requires 1 x 895mm high x 395 wide cabinet door		
450mm TALL WALL UNIT	IH/450TWU	£237.68
Requires 1 x 895mm high x 445 wide cabinet door		
500mm TALL WALL UNIT	IH/500TWU	£244.60
Requires 1 x 895mm high x 495 wide cabinet door		
550mm TALL WALL UNIT	IH/550TWU	£251.48
Requires 1 x 895mm high x 545 wide cabinet door		
600mm TALL WALL UNIT	IH/600TWU	£258.40
Requires 1 x 895mm high x 595 wide cabinet door		

Double Wall Units 900H

WALL UNIT WIDTH	CODE	LIST PRICE
700mm TALL WALL UNIT	IH/700TWU	£290.40
Requires 2 x 955mm high x 345 wide cabinet doors		
800mm TALL WALL UNIT	IH/800TWU	£302.40
Requires 2 x 895mm high x 395 wide cabinet doors		
900mm TALL WALL UNIT	IH/900TWU	£314.40
Requires 2 x 895mm high x 445 wide cabinet doors		
1000mm TALL WALL UNIT	IH/1000TWU	£314.40
Requires 2 x 895mm high x 495 wide cabinet doors		

635 Corner Wall Units 720H

WALL UNIT WIDTH	CODE	LIST PRICE
635mm STANDARD CORNER WALL UNIT 600 WIDE	IH/600SCW	£274.84
Requires 1 x 715mm high x 295 wide cabinet door		

635 Corner Wall Units 900H

WALL UNIT WIDTH	CODE	LIST PRICE
635mm TALL CORNER WALL UNIT 600 WIDE	IH/600TCW	£294.84
Requires 1 x 895mm high x 295 wide cabinet door		

Integro Larder Unit Handle Profiles

Vertical Profiles

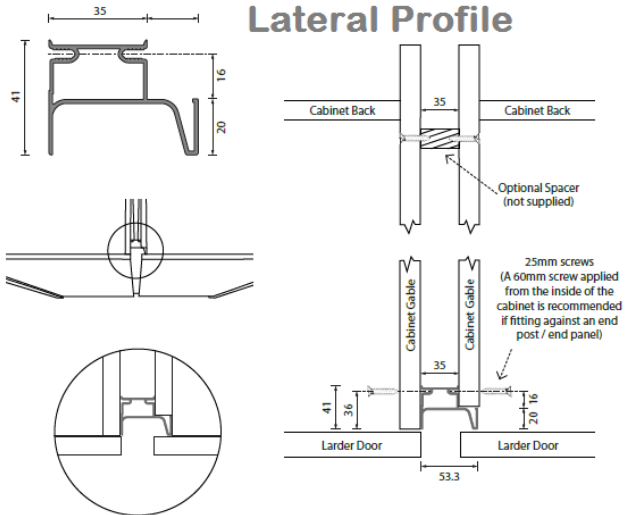

Lateral Profile

Intermediate Profile

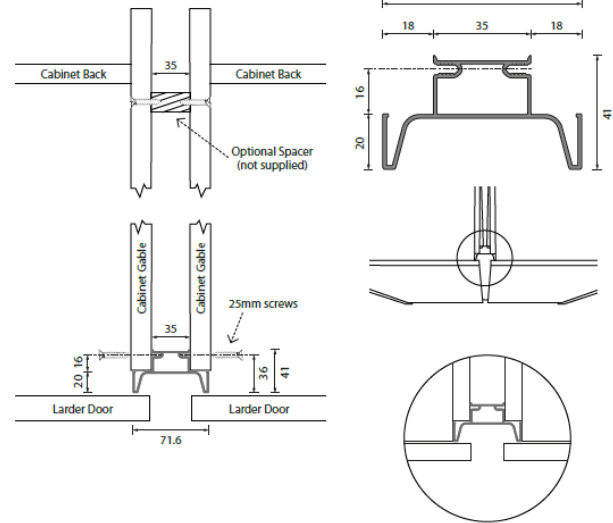

- Used on tall units when you have an opening door on one side only, can also be used to end a run where an end post or end panel is fitted.
- Secured to cabinet gable with 25mm cabinet screws.
- Can be cut to size using a circular chop saw.
- A 35mm spacer (not supplied) is required at the back between two cabinets or between a cabinet and end panel.
- The front of the cabinet gable needs to be set back by 20mm for the trim to overlap behind the door.
- To fix an end post or end panel to the profile you need to drill through the screw support channel and attach the end post from the inside of the cabinet with a 60mm screw.



- Used on tall units when two opening doors meet.
- Secured to cabinet gables with 25mm cabinet screws.
- Can be cut to size using a circular chop saw.
- A 35mm spacer (not supplied) is required at the back between the two cabinets to maintain the void created by the profile trim.
- The front of the cabinet gables need to be set back by 20mm for the trim to overlap behind the doors.

Integro Larder cabinets are not supplied with any handle rail, the required VERTICAL PROFILE must be ordered separately from the options above. All integro larder cabinets are handed according to the hinge side. An integro right hand larder will be hinged on the right hand side and a vertical profile will need to be fitted to the left hand side of the cabinet. 35mm spaces must be allowed for between any adjoining cabinet or end panel to accommodate the vertical profile.

ALUMINIUM

LAT/PROF	2.4 VERTICAL LATERALL PROFILE	£38.16
INT/PROF	2.4 VERTICAL INTERMEDIATE PROFILE	£41.64
APP/SPACER	APPLIANCE SPACER (included with any larder appliance housing)	£27.40

GRAPHITE

GR/INTPROF	GOLA VERTICAL 2.4M INTERMEDIATE PROFILE	£50.54
GR/LATPROF	GOLA VERTICAL 2.4 LATERAL PROFILE	£46.66
GR/APP	GOLA APPLIANCE SPACER (included with any larder appliance housing)	£27.76

COPPER

CO/INTPROF	GOLA VERTICAL 2.4M INTERMEDIATE PROFILE	£58.26
CO/LATPROF	GOLA VERTICAL 2.4 LATERAL PROFILE	£50.20
CO/APP	GOLA APPLIANCE SPACER	£44.32

Integro Larder Units 1970H

LARDER UNIT WIDTH	CODE	LIST PRICE
300mm LARDER UNIT 1970H LEFT HAND (2 DOOR)	IH/300SLU/LH	£548.32
Requires 1 x 715mm high x 295 wide & 1 x 1245 x 295 wide cabinet door		
300mm LARDER UNIT 1970H RIGHT HAND (2 DOOR)	IH/300SLU/RH	£548.32
Requires 1 x 715mm high x 295 wide & 1 x 1245 x 295 wide cabinet door		
300mm LARDER UNIT 1970H FULL HEIGHT DOOR L/H	IH/FHD300SLU/LH	£548.32
Requires 1 x 1965mm high x 295 wide cabinet door		
300mm LARDER UNIT 1970H FULL HEIGHT DOOR R/H	IH/FHD300SLU/RH	£548.32
Requires 1 x 1965mm high x 295 wide cabinet door		
400mm LARDER UNIT 1970H LEFT HAND (2 DOOR)	IH/400SLU/LH	£580.44
Requires 1 x 715mm high x 395 wide & 1 x 1245 x 395 wide cabinet door		
400mm LARDER UNIT 1970H RIGHT HAND (2 DOOR)	IH/400SLU/RH	£580.44
Requires 1 x 715mm high x 395 wide & 1 x 1245 x 395 wide cabinet door		
400mm LARDER UNIT 1970H FULL HEIGHT DOOR L/H	IH/FHD400SLU/LH	£580.44
Requires 1 x 1965mm high x 295 wide cabinet door		
400mm LARDER UNIT 1970H FULL HEIGHT DOOR R/H	IH/FHD400SLU/RH	£580.44
Requires 1 x 1965mm high x 395 wide cabinet door		
500mm LARDER UNIT 1970H LEFT HAND (2 DOOR)	IH/500SLU/LH	£612.60
Requires 1 x 715mm high x 395 wide & 1 x 1245 x 295 wide cabinet door		
500mm LARDER UNIT 1970H RIGHT HAND (2 DOOR)	IH/500SLU/RH	£612.60
Requires 1 x 715mm high x 495 wide & 1 x 1245 x 495 wide cabinet door		
500mm LARDER UNIT 1970H FULL HEIGHT DOOR L/H	IH/FHD500SLU/LH	£612.60
Requires 1 x 1965mm high x 495 wide cabinet door		
500mm LARDER UNIT 1970H FULL HEIGHT DOOR R/H	IH/FHD500SLU/RH	£612.60
Requires 1 x 1965mm high x 495 wide cabinet door		
600mm LARDER UNIT 1970H LEFT HAND (2 DOOR)	IH/600SLU/LH	£644.08
Requires 1 x 715mm high x 595 wide & 1 x 1245 x 595 wide cabinet door		
600mm LARDER UNIT 1970H RIGHT HAND (2 DOOR)	IH/600SLU/RH	£644.08
Requires 1 x 715mm high x 595 wide & 1 x 1245 x 595 wide cabinet door		
600mm LARDER UNIT 1970H FULL HEIGHT DOOR L/H	IH/FHD600SLU/LH	£644.08
Requires 1 x 1965mm high x 595 wide cabinet door		
600mm LARDER UNIT 1970H FULL HEIGHT DOOR R/H	IH/FHD600SLU/RH	£644.08
Requires 1 x 1965mm high x 595 wide cabinet door		

Integro Larder Units 2150H

LARDER UNIT WIDTH	CODE	LIST PRICE
300mm LARDER UNIT 2150H LEFT HAND (2 DOOR)	IH/300TLU/LH	£588.32
Requires 1 x 895mm high x 295 wide & 1 x 1245 x 295 wide cabinet door		
300mm LARDER UNIT 2150H RIGHT HAND (2 DOOR)	IH/300TLU/RH	£588.32
Requires 1 x 895mm high x 295 wide & 1 x 1245 x 295 wide cabinet door		
300mm LARDER UNIT 2150H FULL HEIGHT DOOR L/H	IH/FHD300TLU/LH	£588.32
Requires 1 x 2145mm high x 295 wide cabinet door (PIATTO & GLACIER ONLY)		
300mm LARDER UNIT 2150H FULL HEIGHT DOOR R/H	IH/FHD300TLU/RH	£588.32
Requires 1 x 2145mm high x 295 wide cabinet door (PIATTO & GLACIER ONLY)		
400mm LARDER UNIT 2150H LEFT HAND (2 DOOR)	IH/400TLU/LH	£620.44
Requires 1 x 895mm high x 395 wide & 1 x 1245 x 395 wide cabinet door		
400mm LARDER UNIT 2150H RIGHT HAND (2 DOOR)	IH/400TLU/RH	£620.44
Requires 1 x 895mm high x 395 wide & 1 x 1245 x 395 wide cabinet door		
400mm LARDER UNIT 2150H FULL HEIGHT DOOR L/H	IH/FHD400TLU/LH	£620.44
Requires 1 x 2145mm high x 295 wide cabinet door (PIATTO & GLACIER ONLY)		

400mm LARDER UNIT 2150H FULL HEIGHT DOOR R/H	IH/FHD400TLU/RH	£620.44
Requires 1 x 2145mm high x 395 wide cabinet door (PIATTO & GLACIER ONLY)		
500mm LARDER UNIT 2150H LEFT HAND (2 DOOR)	IH/500TLU/LH	£652.60
Requires 1 x 895mm high x 395 wide & 1 x 1245 x 295 wide cabinet door		
500mm LARDER UNIT 2150H RIGHT HAND (2 DOOR)	IH/500TLU/RH	£652.60
Requires 1 x 895mm high x 495 wide & 1 x 1245 x 495 wide cabinet door		
500mm LARDER UNIT 2150H FULL HEIGHT DOOR L/H	IH/FHD500TLU/LH	£652.60
Requires 1 x 2145mm high x 495 wide cabinet door (PIATTO & GLACIER ONLY)		
500mm LARDER UNIT 2150H FULL HEIGHT DOOR R/H	IH/FHD500TLU/RH	£652.60
Requires 1 x 2145mm high x 495 wide cabinet door (PIATTO & GLACIER ONLY)		
600mm LARDER UNIT 2150H LEFT HAND (2 DOOR)	IH/600TLU/LH	£684.08
Requires 1 x 895mm high x 595 wide & 1 x 1245 x 595 wide cabinet door		
600mm LARDER UNIT 2150H RIGHT HAND (2 DOOR)	IH/600TLU/RH	£684.08
Requires 1 x 895mm high x 595 wide & 1 x 1245 x 595 wide cabinet door		
600mm LARDER UNIT 2150H FULL HEIGHT DOOR L/H	IH/FHD600TLU/LH	£684.08
Requires 1 x 2145mm high x 595 wide cabinet door (PIATTO & GLACIER ONLY)		
600mm LARDER UNIT 2150H FULL HEIGHT DOOR R/H	IH/FHD600TLU/RH	£684.08
Requires 1 x 2145mm high x 595 wide cabinet door (PIATTO & GLACIER ONLY)		

Fridge Freezer Housings 1970H

HOUSING TYPE	CODE	LIST PRICE
STAN 50/50 FRIDGE FREEZER HOUSING LEFT HAND	IH/S50/50/LH	£569.96
Requires 2 x 980 high x 595 wide cabinet doors		
STAN 50/50 FRIDGE FREEZER HOUSING RIGHT HAND	IH/S50/50/RH	£569.96
Requires 2 x 980 high x 595 wide cabinet doors		
STAN 70/30 FRIDGE FREEZER HOUSING LEFT HAND	IH/S70/30/LH	£569.96
Requires 1 x 715mm high x 595 wide & 1 x 1245 x 595 wide cabinet door		
STAN 70/30 FRIDGE FREEZER HOUSING RIGHT HAND	IH/S70/30/RH	£569.96
Requires 1 x 715mm high x 595 wide & 1 x 1245 x 595 wide cabinet door		
STAN LARDER FRIDGE HOUSING LEFT HAND	IH/SLARFRI/LH	£569.96
Requires 1 x 1955mm high x 595 wide cabinet door		
STAN LARDER FRIDGE HOUSING RIGHT HAND	IH/SLARFRI/RH	£569.96
Requires 1 x 1955mm high x 595 wide cabinet door		

Fridge Freezer Housings 1970H

HOUSING TYPE	CODE	LIST PRICE
TALL 50/50 FRIDGE FREEZER HOUSING LEFT HAND	IH/T50/50/LH	£609.96
Requires 2 x 980 high x 595 wide 1 x 175 high x 595 wide cabinet doors		
TALL 50/50 FRIDGE FREEZER HOUSING RIGHT HAND	IH/T50/50/RH	£609.96
Requires 2 x 980 high x 595 wide 1 x 175 high x 595 wide cabinet doors		
TALL 70/30 FRIDGE FREEZER HOUSING LEFT HAND	IH/T70/30/LH	£609.96
Requires 1 x 715mm high x 595 wide & 1 x 1245 x 595 wide & 1 x 175 high x 595 wide cabinet doors		
TALL 70/30 FRIDGE FREEZER HOUSING RIGHT HAND	IH/T70/30/RH	£609.96
Requires 1 x 715mm high x 595 wide & 1 x 1245 x 595 wide & 1 x 175 high 595 wide cabinet doors		
TALL LARDER FRIDGE HOUSING LEFT HAND	IH/TLARFRI/LH	£609.96
Requires 1 x 2145mm high x 595 wide cabinet door (PIATTO & GLACIER ONLY)		
TALL LARDER FRIDGE HOUSING RIGHT HAND	IH/TLARFRI/RH	£609.96
Requires 1 x 2145mm high x 595 wide cabinet door (PIATTO & GLACIER ONLY)		

Installing Ovens In Tall Housings

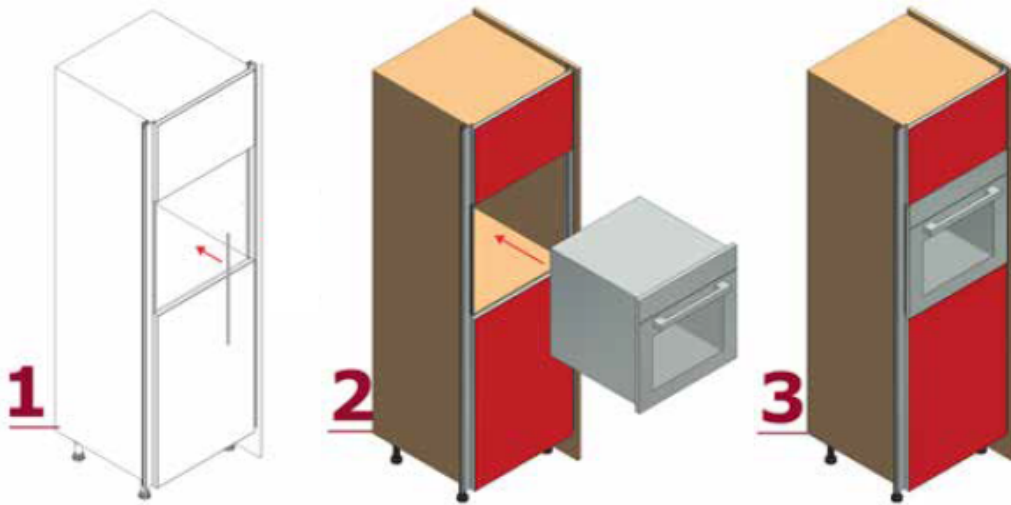

Dimensions

580 x 19.6 x 20.8mm



- Used to conceal the space behind the front of an appliance when used in an appliance housing unit combined with vertical Vero profiles.
- Fixed into the cabinet gable with 4 x 16mm screws.
- Works with both intermediate and lateral vertical profiles.
- The trim can be cut down to suit different sized appliances. If doing so, we recommend that a metal file is used to remove any sharp edges on the cut edge and that it is positioned out of sight.
- If the appliance requires a screw fixing into the cabinet, the spacer can be drilled into to accommodate the screws.
- When stacking appliances, we recommend leaving a 10mm gap to the top and bottom of both appliances.

DIMENSIONS

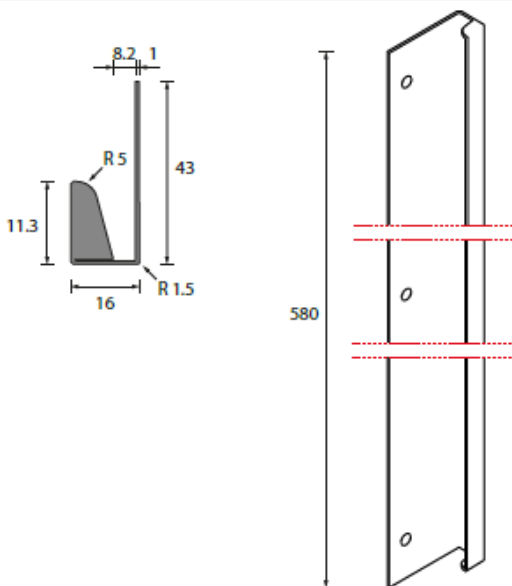

FITTED DETAIL

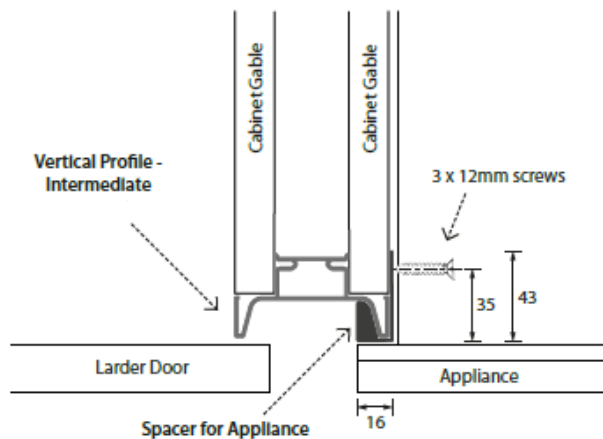

Installing Built Under Appliances

- The Top Profile can be used to run above integrated appliance.
- It's recommended to set integrated dishwasher height at 815mm to fit under the rail.
- Metal brackets (supplied with dishwasher) should be fixed to the outer face of adjacent cabinets. Please note, an additional bracing baton may be required to the rear of the machine to help reduce movement.
- If drawers are situated next to an integrated appliance, we recommend using end caps to cover any gaps.

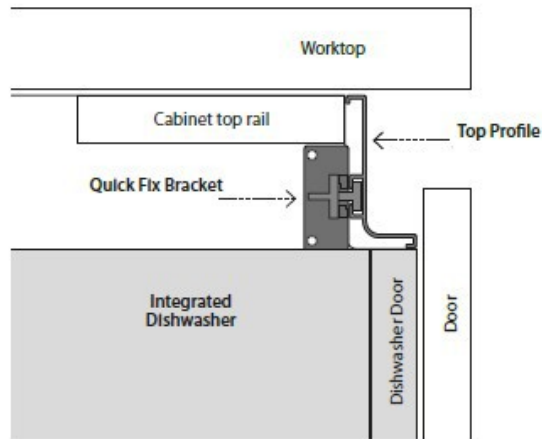

IMPORTANT INFORMATION

We recommend extending the cabinet legs to at minimum height of 155mm to ensure the integrated dishwasher will fit underneath the top rail.

It is also recommended to set integrated dishwasher height at 815mm.

Integrated dishwasher combined with Vero handleless rail system



Built Under Ovens

- The Top Profile can't be used in conjunction with an under mounted oven. Profiles must stop on each side of the appliance and can be finished with end caps.
- If using a freestanding cooker, end panels will need to be fitted either side of the appliance and the profile finished against the panel.

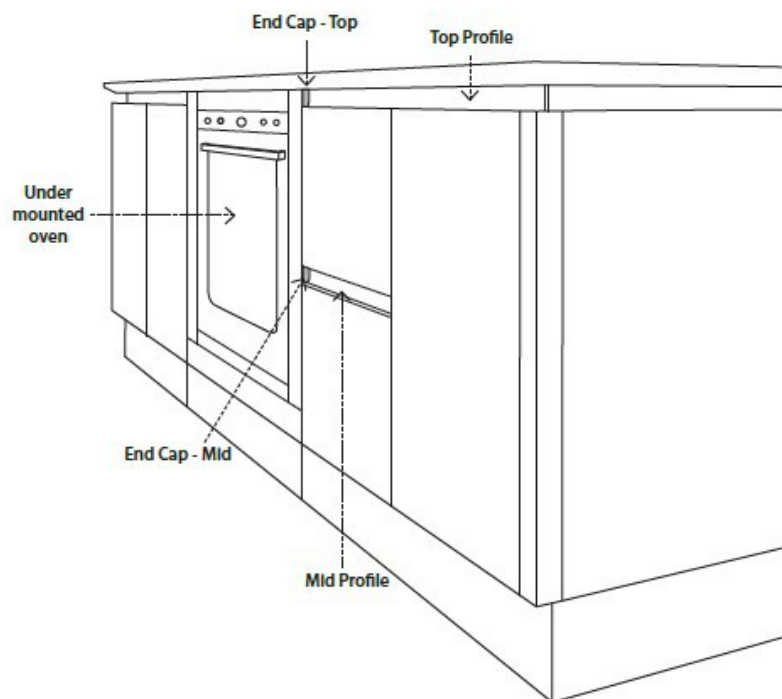

Built Under Single Oven Housing 720H

HOUSING TYPE	CODE	LIST PRICE
BUILT UNDER OVEN HOUSING BASE UNIT 720H	IH/OVEN	£179.28
Requires 1 x 110 x 595 blank panel		

Single Oven Larder Housing 1970H

HOUSING TYPE	CODE	LIST PRICE
SINGLE OVEN HOUSING 645H TOP DOOR LEFT HAND	IH/SSOVEN/LH	£646.72
Requires 1 x 715 high x 595 wide & 1 x 645 high x 595 wide doors		
SINGLE OVEN HOUSING 645H TOP DOOR RIGHT HAND	IH/SSOVEN/RH	£646.72
Requires 1 x 715 high x 595 wide & 1 x 645 high x 595 wide doors		

Single Oven Larder Housing 2150H

HOUSING TYPE	CODE	LIST PRICE
TALL SINGLE OVEN HOUSING LEFT HAND	IH/TSOVEN/LH	£686.72
Requires 2 x 715 high x 595 wide & 1 x 110 high x 595 wide doors		
TALL SINGLE OVEN HOUSING RIGHT HAND	IH/TSOVEN/RH	£686.72
Requires 2 x 715 high x 595 wide & 1 x 110 high x 595 wide doors		

Double Oven Larder Housing 1970H

HOUSING TYPE	CODE	LIST PRICE
DOUBLE OVEN HOUSING UNIT LEFT HAND	IH/SD/OVEN/LH	£706.32
Requires 1 x 570 high x 595 wide & 1 x 490 high x 595 wide doors		
DOUBLE OVEN HOUSING UNIT RIGHT HAND	IH/SD/OVEN/RH	£706.32
Requires 1 x 570 high x 595 wide & 1 x 490 high x 595 wide doors		

Double Oven Larder Housing 2150H

HOUSING TYPE	CODE	LIST PRICE
TALL DOUBLE OVEN HOUSING UNIT LEFT HAND	IH/TD/OVEN/LH	£746.32
Requires 1 x 570 high x 595 wide & 1 x 490 high x 595 & 1 x 175 high 595 wide doors		
TALL DOUBLE OVEN HOUSING UNIT RIGHT HAND	IH/TD/OVEN/RH	£746.32
Requires 2 x 715 high x 595 wide & 1 x 110 high x 595 & 1 x 175 high 595 wide doors		

Single Oven & Microwave Larder Housing 1970H

HOUSING TYPE	CODE	LIST PRICE
SINGLE OVEN & 380H MICRO HOUSING LEFT HAND	IH/SSOMICRO1/LH	£675.68
Requires 2 x 490 high x 595 wide doors		
SINGLE OVEN & 380H MICRO HOUSING RIGHT HAND	IH/SSOMICRO1/RH	£675.68
Requires 2 x 490 high x 595 wide doors		
SINGLE OVEN & 460H MICRO HOUSING LEFT HAND	IH/SSOMICRO2/LH	£691.76
Requires 2 x 450 high x 595 wide doors		
SINGLE OVEN & 460H MICRO HOUSING RIGHT HAND	IH/SSOMICRO2/RH	£691.76
Requires 2 x 450 high x 595 wide doors		

Single Oven & Microwave Larder Housing 2150H

HOUSING TYPE	CODE	LIST PRICE
TALL SINGLE OVEN & 380H MICRO HOUSING LEFT HAND	IH/TSOMICRO1/LH	£715.68
Requires 2 x 490 high x 595 wide & 1 x 175 high x 595 wide doors		
TALL SINGLE OVEN & 380H MICRO HOUSING RIGHT HAND	IH/TSOMICRO1/RH	£715.68
Requires 2 x 490 high x 595 wide 1 x 175 high x 595 wide doors		
TALL SINGLE OVEN & 460H MICRO HOUSING LEFT HAND	IH/TSOMICRO2/LH	£731.76
Requires 2 x 450 high x 595 wide 1 x 175 high x 595 wide doors		
TALL SINGLE OVEN & 460H MICRO HOUSING RIGHT HAND	IH/TSOMICRO2/RH	£731.76
Requires 2 x 450 high x 595 wide 1 x 175 high x 595 wide doors		

Larder Housings To Suit Pull Out Wirework 1970H

IMPORTANT

Integro larder pull out cabinets are supplied **WITHOUT THE PULL OUT WIREWORK**. This can be ordered separately in a number of various options, see page 105 & 106. Your chosen wirework will be boxed separately and will need to be installed into your cabinet.

HOUSING TYPE	CODE	LIST PRICE
300mm LARDER PULL OUT UNIT LEFT HAND	IH/FHD300SPL/LH	£531.68
Requires 1 x 1965mm high x 295 wide cabinet door		
300mm LARDER PULL OUT UNIT RIGHT HAND	IH/FHD300SPL/RH	£531.68
Requires 1 x 1965mm high x 295 wide cabinet door		
400mm LARDER PULL OUT UNIT LEFT HAND	IH/FHD400SPL/LH	£563.80
Requires 1 x 1965mm high x 395 wide cabinet door		
400mm LARDER PULL OUT UNIT RIGHT HAND	IH/FHD400SPL/RH	£563.80
Requires 1 x 1965mm high x 395 wide cabinet door		
500mm PANTRY PULL OUT UNIT LEFT HAND	IH/FHD500SPL/LH	£620.76
Requires 1 x 1965mm high x 495 wide cabinet door		
500mm PANTRY PULL OUT UNIT RIGHT HAND	IH/FHD500SPL/RH	£620.76
Requires 1 x 1965mm high x 495 wide cabinet door		
600mm PANTRY PULL OUT UNIT LEFT HAND	IH/FHD600SPL/LH	£652.24
Requires 1 x 1965mm high x 595 wide cabinet door		
600mm PANTRY PULL OUT UNIT RIGHT HAND	IH/FHD600SPL/RH	£652.24
Requires 1 x 1965mm high x 595 wide cabinet door		

Larder Housings To Suit Pull Out Wirework 2150H

IMPORTANT

Integro larder pull out cabinets are supplied WITHOUT THE PULL OUT WIREWORK. This can be ordered separately in a number of various options, see page 105 & 106. Your chosen wirework will be boxed separately and will need to be installed into your cabinet.

HOUSING TYPE	CODE	LIST PRICE
300mm TALL LARDER PULL OUT UNIT LEFT HAND	IH/FHD300TPL/LH	£596.48
Requires 1 x 2145 high x 295 wide cabinet door (PIATTO & GLACIER ONLY)		
300mm TALL LARDER PULL OUT UNIT RIGHT HAND	IH/FHD300TPL/RH	£596.48
Requires 1 x 2145 high x 295 wide cabinet door (PIATTO & GLACIER ONLY)		
400mm TALL LARDER PULL OUT UNIT LEFT HAND	IH/FHD400TPL/LH	£628.60
Requires 1 x 2145 high x 395 wide cabinet door (PIATTO & GLACIER ONLY)		
400mm TALL LARDER PULL OUT UNIT RIGHT HAND	IH/FHD400TPL/RH	£628.60
Requires 1 x 2145 high x 395 wide cabinet door (PIATTO & GLACIER ONLY)		
500mm TALL PANTRY PULL OUT UNIT LEFT HAND	IH/FHD500TPL/LH	£660.76
Requires 1 x 2145 high x 495 wide cabinet door (PIATTO & GLACIER ONLY)		
500mm TALL PANTRY PULL OUT UNIT RIGHT HAND	IH/FHD500TLP/RH	£660.76
Requires 1 x 2145 high x 495 wide cabinet door (PIATTO & GLACIER ONLY)		
600mm TALL PANTRY PULL OUT UNIT LEFT HAND	IH/FHD600TPL/LH	£692.24
Requires 1 x 2145 high x 595 wide cabinet door (PIATTO & GLACIER ONLY)		
600mm TALL PANTRY PULL OUT UNIT RIGHT HAND	IH/FHD600TPL/RH	£692.24
Requires 1 x 2145 high x 595 wide cabinet door (PIATTO & GLACIER ONLY)		

Integro Handle Profile & Components Aluminium

STOCK CODE	DESCRIPTION	PRICE
ALUMINIUM		
WALL/PROF3.9	3.9M HANDLE PROFILE FOR WALL UNIT	£31.79
TOP/PROF4.1	4.1M HANDLE TOP PROFILE FOR BASE UNIT	£48.84
TOP/ENDCAP	PAIR OF END CAPS FOR TOP PROFILE	£21.60
TOP/INTCOR	INTERNAL CORNER SECTION FOR TOP PROFILE	£32.16
TOP/EXTCOR	EXTERNAL CORNER SECTION FOR TOP PROFILE	£31.46
MID/PROF4.1	4.1M HANDLE FOR MID BASE PROFILE	£41.96
MID/ENDCAP	PAIR OF END CAPS FOR MID PROFILE	£21.88
MID/INTCOR	INTERNAL CORNER SECTION FOR MID PROFILE	£38.28
MID/EXTCOR	EXTERNAL CORNER SECTION FOR MID PROFILE	£42.40
LAT/PROF	2.4 VERTICAL LATERALL PROFILE	£38.16
INT/PROF	2.4 VERTICAL INTERMEDIATE PROFILE	£41.64
APP/SPACER	APPLIANCE SPACER	£27.40
PLINTH/PAN	PLINTH PANEL 145X3000MM ALU SILVER	£55.86
STRA/CON	PLINTH STRAIGHT CONNECTOR ALU SILVER	£4.36
90D/CON	PLINTH 90 DEGREE CONNECTOR ALU SILVER	£7.50

FIXING BRACKETS

PROF/CON	TOP & MID PROFILE CONNECTOR	£1.92
PLIN/CLIP	PLINTH CLIP (EACH)	£0.26

Integro Handle Profile & Components Graphite

STOCK CODE	DESCRIPTION	PRICE
GRAPHITE		
GR/TOPPROF	GOLA 4.1M TOP PROFILE FOR BASE	£40.80
GR/TOPEND	GOLA TOP PROFILE END CAPS (1XPAIR)	£27.00
GR/TOPINT	GOLA TOP PROFILE INTERNAL CORNER SECTION	£29.40
GR/TOPEXT	GOLA TOP PROFILE EXTERNAL CORNER SECTION	£29.40
GR/MIDPROF	GOLA 4.1M MID PROFILE FOR BASE	£50.88
GR/MIDEND	GOLA MID PROFILE END CAPS (1XPAIR)	£27.00
GR/MIDINT	GOLA MID PROFILE INTERNAL CORNER SECTION	£39.72
GR/MIDEXT	GOLA MID PROFILE EXTERNAL CORNER SECTION	£42.40
GR/INTPROF	GOLA VERTICAL 2.4M INTERMEDIATE PROFILE	£50.54
GR/LATPROF	GOLA VERTICAL 2.4 LATERAL PROFILE	£46.66
GR/APP	GOLA APPLIANCE SPACER	£27.76
GR/PLINPAN	GOLA PLINTH PANEL 145X3000MM ALU GRAPHITE	£54.06
GR/STRACON	GOLA PLINTH STRAIGHT CONNECTOR ALU GRAPHITE	£3.92
GR/90DCON	GOLA PLINTH 90 DEGREE CONNECTOR ALU GRAPHITE	£7.80

FIXING BRACKETS		
PROF/CON	TOP & MID PROFILE CONNECTOR	£1.92
PLIN/CLIP	PLINTH CLIP (EACH)	£0.26

Integro Handle Profile & Components Copper

STOCK CODE	DESCRIPTION	PRICE
COPPER		
CO/TOPPROF	GOLA 4.1M TOP PROFILE FOR BASE	£63.12
CO/TOPEND	GOLA TOP PROFILE END CAPS (1XPAIR)	£32.34
CO/TOPINT	GOLA TOP PROFILE INTERNAL CORNER SECTION	£29.54
CO/TOPEXT	GOLA TOP PROFILE EXTERNAL CORNER SECTION	£29.54
CO/MIDPROF	GOLA 4.1M MID PROFILE FOR BASE	£73.02
CO/MIDEND	GOLA MID PROFILE END CAPS (1XPAIR)	£33.90
CO/MIDINT	GOLA MID PROFILE INTERNAL CORNER SECTION	£41.68
CO/MIDEXT	GOLA MID PROFILE EXTERNAL CORNER SECTION	£42.48
CO/INTPROF	GOLA VERTICAL 2.4M INTERMEDIATE PROFILE	£58.26
CO/LATPROF	GOLA VERTICAL 2.4 LATERAL PROFILE	£50.20
CO/APP	GOLA APPLIANCE SPACER	£44.32
CO/PLINPAN	GOLA PLINTH PANEL 145X3000MM ALU GRAPHITE	£79.70
CO/STRACON	GOLA PLINTH STRAIGHT CONNECTOR ALU GRAPHITE	£3.92
CO/90DCON	GOLA PLINTH 90D CONNECTOR ALU GRAPHITE	£9.88

FIXING BRACKETS		
PROF/CON	TOP & MID PROFILE CONNECTOR	£1.92
PLIN/CLIP	PLINTH CLIP (EACH)	£0.26



150mm Base Unit Pull Out Bottle Rack / Towel Rail

Cabinet widths: 150mm

No. of trays: 2 versions – 2 trays / towel holder and tray

Load capacity:- 10kg per tray

Soft close:- YES

CODE:- KTBP150SILV (2 x Bottle Trays)

CODE:- KTRBP150SILV (Towel Rail & 1 Tray)



300mm & 400mm Base Unit Pull Out

Cabinet widths: 300mm & 400mm

No. of trays: 2

Load capacity:- 24kg Total

Soft close:- YES

CODE:- KBP300SILV (300mm)

CODE:- KBP400SILV (400mm)

Dynamic Storage



150mm Base Unit Pull Out

Cabinet widths: 150mm

No. of trays: 2

Load capacity:- 25kg total

Soft close:- YES

CODE:- 150DPB



150mm Towel Rail

Cabinet widths: 150mm

No. of trays: 1 + Towel rail

Load capacity:- 25kg total

Soft close:- YES

CODE:- 150POTR



300mm Base Unit Pull Out

Cabinet widths: 300mm

No. of trays: 2

Load capacity:- 25kg total

Soft close:- YES

CODE:- 300DPB



900mm—1000mm Magic Corner (L/H DOOR ILLUSTRATED)

Cabinet widths: 900mm—1000mm (450mm Door Min)

No. of trays: 2 door trays & 2 internal trays

Load capacity:- 14kg door trays, 18kg internal trays

Soft close:- YES

L/H DOOR CODE:- KMCUSILVL

R/H DOOR CODE:- KMCUSILVR



900mm—1100mm Arena LeMans Corner (L/H DOOR ILLUSTRATED)

No. of trays: 2

Load capacity:- 25kg Per tray

Soft close:- NO

Cabinet widths: 900mm (450 Door L/H) CODE:- KLM450SILVL

Cabinet widths: 900mm (450 Door R/H) CODE:- KLM450SILVR

Cabinet widths: 1000mm (500 Door L/H) CODE:- KLM500SILVL

Cabinet widths: 1000mm (500 Door R/H) CODE:- KLM500SILVR

Cabinet widths: 1100mm (600 Door L/H) CODE:- KLM600SILVL

Cabinet widths: 1100mm (600 Door R/H) CODE:- KLM600SILVR

Dynamic Storage



900mm—1000mm Magic Corner (L/H DOOR ILLUSTRATED)

Cabinet widths: 900mm—1000mm (450mm Door Min)

No. of trays: 2 door trays & 2 internal trays

Load capacity:- 35kg Total

Soft close:- YES

L/H DOOR CODE:- MAGICL/H

R/H DOOR CODE:- MAGICR/H



900mm—1000mm Combi Corner (R/H DOOR ILLUSTRATED)

No. of trays: 2

Load capacity:- 20kg Per tray

Soft close:- NO

Cabinet widths: 900mm (450 Door L/H) CODE:- 450COMBILH

Cabinet widths: 900mm (450 Door R/H) CODE:- 450COMBIRH

Cabinet widths: 1000mm (500 Door L/H) CODE:- 500COMBILH

Cabinet widths: 1000mm (500 Door R/H) CODE:- 500COMBIRH

Wirework - Larder Pull Out



Dynamic Storage



300mm & 400mm Larder Unit Pull Out

Cabinet widths: 300mm & 400mm

No. of trays: 5

Load capacity:- 100kg total

Soft close:- YES

300mm CODE:- KLF300FESILV

400mm CODE:- KLF400FESILV



300mm & 400mm Larder Unit Pull Out

Cabinet widths: 300mm & 400mm

No. of trays: 5

Load capacity:- 100kg total

Soft close:- YES

300mm CODE:- 300DPL

400mm CODE:- 400DPL

Wirework - Pantry Pull Out



600mm Tandem Larder Pantry System

Cabinet widths: 600mm

No. of trays: 6 Internal trays & 6 Door trays

Load capacity:- 50kg Internal trays & 20kg Door trays total

Soft close:- YES

600mm CODE:- KTLF600SILV



Dynamic Storage



600mm Pegasus Larder Pantry System

Cabinet widths: 500mm & 600mm

No. of trays: 5 Trays

Load capacity:- 100kg Total

Soft close:- YES

500mm CODE:- 500DPL

600mm CODE:- 600DPL

Wirework - Pull Out Baskets

Dynamic Storage

400mm, 500mm & 600mm Pull Out Baskets

Cabinet widths: 400mm, 500mm & 600mm

Load capacity:- 20kg Per basket

Soft close:- YES

400mm CODE:- 400POBW

500mm CODE:- 500POBW

600mm CODE:- 600POBW

6 x Baskets installed into a larder unit gives maximum weight capacity.



HETTICH DRAWER BOXES WITH INTERNAL FRONTS

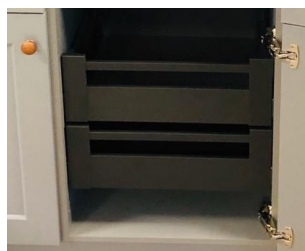

PLEASE NOTE:-

When adding internal drawer boxes into ANY cabinet, you will need to add a pair of 165 degree hinges for each door on that particular cabinet.

INTERNAL DRAWER BOXES INCLUDING DRAWER FRONT

INTERNAL DRAWER BOXES INCLUDING DRAWER FRONT		
INDR/S300	INTERNAL STANDARD 300MM DRAWER INC FRONT	£95.35
INDR/S400	INTERNAL STANDARD 400MM DRAWER INC FRONT	£97.35
INDR/S500	INTERNAL STANDARD 500MM DRAWER INC FRONT	£99.39
INDR/S600	INTERNAL STANDARD 600MM DRAWER INC FRONT	£101.39
INDR/S800	INTERNAL STANDARD 800MMDRAWER INC FRONT	£113.46
INDR/S900	INTERNAL STANDARD 900MM DRAWER INC FRONT	£115.50
INDR/S100	INTERNAL STANDARD 1000MM DRAWER INC FRONT	£117.54
INDR/P300	INTERNAL PAN 300MM DRAWER INC FRONT	£143.33
INDR/P400	INTERNAL PAN 400MM DRAWER INC FRONT	£145.33
INDR/P500	INTERNAL PAN 500MM DRAWER INC FRONT	£147.37
INDR/P600	INTERNAL PAN 600MM DRAWER INC FRONT	£149.37
INDR/P800	INTERNAL PAN 800MMDRAWER INC FRONT	£161.49
INDR/P900	INTERNAL PAN 900MM DRAWER INC FRONT	£163.49
INDR/P100	INTERNAL PAN 1000MM DRAWER INC FRONT	£165.53
HP165/SC	PAIR OF 165 DEG SOFT CLOSE HINGES INC PLATES	£8.40

BEDROOM RANGES

Piatto is a slab style door manufactured using high grade melamine faced chip-board, edged using a durable ABS colour matched edging. All our Piatto doors are edged using a PUR gluing system, making this range the most hardwearing and moisture resistant range we offer. Piatto is available in a wide range of different textures, colours and finishes, and is available in made to measure sizes.



PIATTO PLUS WOODGRAINS



PASADINA PINE



WHITE HALIFAX OAK



PEWTER HALIFAX OAK



WHITEWOOD



KAISENBERG OAK



LINCOLN WALNUT



ANTHRACITE FINELINE METALIC



TRUFFLE BROWN BRANSON ROBINIA



SAND GREY GLAZED HALIFAX OAK



NATURAL HALIFAX OAK

Why not try a contrasting door and cabinet colour?

The image shown has a white Halifax oak cabinet colour and PIATTO PLUS doors in WHITEWOOD.



CASCINA PINE



VILLAGE SANTA FE OAK



GREY SANTA FE OAK

PIATTO PLUS PAINTED WOOD EFFECT



INDIGO BLUE
WOOD EFFECT



GRAPHITE
GREY



STONE GREY
WOOD EFFECT

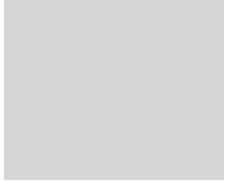

LIGHT GREY
WOOD EFFECT



FJORD GREEN
WOOD EFFECT

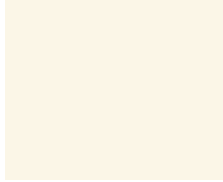

ALABASTER
WOOD EFFECT



PIATTO PLUS INDUSTRIAL EFFECT



ANTHRACITE LINEN



GREY TEXTILE

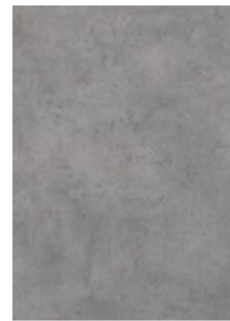

CHICAGO CONCRETE



BLACK GOLD METAL SLATE



ANTHRACITE METAL ROCK



SILVER GREY METAL SLATE

SIZE	PRICE £	SIZE	PRICE £	SIZE	PRICE £
110X595 BLANK	£12.26	283X995 DOOR	£19.70	715X395 DOOR	£19.74
120X495 DRAWER	£12.04	325X495 DOOR	£15.54	715X445 DOOR	£21.92
120X595 DRAWER	£12.46	325X595 DOOR	£16.66	715X495 DOOR	£24.40
120X695 DRAWER	£12.88	325X795 DOOR	£18.90	715X545 DOOR	£26.84
120X795 DRAWER	£13.28	325X895 DOOR	£20.04	715X595 DOOR	£29.32
120X895 DRAWER	£13.70	325X995 DOOR	£22.28	895X295 DOOR	£19.10
120X995 DRAWER	£14.12	355X295 DOOR	£15.82	895X395 DOOR	£24.28
140X295 DRAWER	£11.42	355X495 DOOR	£16.06	895X445 DOOR	£27.44
140X395 DRAWER	£11.90	355X595 DOOR	£17.28	895X495 DOOR	£30.52
140X445 DRAWER	£12.14	355X795 DOOR	£19.72	895X595 DOOR	£36.72
140X495 DRAWER	£12.38	355X895 DOOR	£21.88	980X595 DOOR	£40.20
140X595 DRAWER	£12.88	355X995 DOOR	£24.36	1245X295 DOOR	£25.32
140X795 DRAWER	£13.84	450X595 DOOR	£19.22	1245X395 DOOR	£33.88
140X895 DRAWER	£14.32	490X595 DOOR	£20.08	1245X445 DOOR	£38.20
140X995 DRAWER	£14.80	570X295 DOOR	£15.80	1245X595 DOOR	£42.48
160X495 DRAWER	£12.72	570X395 DOOR	£17.76	1795X345 DOOR	£42.68
160X595 DRAWER	£13.28	570X445 DOOR	£18.74	1795X395 DOOR	£48.88
160X795 DRAWER	£14.38	570X495 DOOR	£19.72	1795X445 DOOR	£55.04
160X895 DRAWER	£14.94	570X595 DOOR	£23.36	1795X495 DOOR	£61.24
160X995 DRAWER	£15.48	645X595 DOOR	£26.44	1795X595 DOOR	£73.60
175X395 DRAWER	£12.38	685X145 DOOR	£16.90	1965X295 DOOR	£39.96
175X495 DRAWER	£12.98	685X295 DOOR	£16.96	1965X395 DOOR	£53.48
175X595 DRAWER	£13.58	685X345 DOOR	£18.14	1965X495 DOOR	£67.04
245X495 DRAWER	£14.18	685X395 DOOR	£19.32	1965X595 DOOR	£80.56
245X595 DRAWER	£15.02	685X445 DOOR	£21.00	2145X295 DOOR	£44.00
245X695 DRAWER	£15.86	685X495 DOOR	£23.36	2145X395 DOOR	£52.00
245X795 DRAWER	£16.72	685X545 DOOR	£25.72	2145X495 DOOR	£76.00
245X895 DRAWER	£17.56	685X595 DOOR	£28.08	2145X595 DOOR	£84.00
245X995 DRAWER	£18.40	715X145 DOOR	£13.58	2295X345 DOOR	£54.80
283X495 DOOR	£14.82	715X255 DOOR	£16.28	2295X395 DOOR	£62.48
283X595 DOOR	£15.80	715X295 DOOR	£17.26	2295X445 DOOR	£70.40
283X795 DOOR	£17.76	715X313 DOOR	£17.72	2295X495 DOOR	£78.28
283X895 DOOR	£18.74	715X345 DOOR	£18.50	2295X545 DOOR	£86.20

MATCHING ACCESSORIES (MELAMINE PANELS)

CODE	DESCRIPTION	PRICE £	CODE	DESCRIPTION	PRICE £
WG2/CORNICE	2700X80MM CORNICE 2	£49.72	WG2/LEPAN	2400X650MM LARDER END PANEL 7	£124.28
WG2/PLINTH	2650X150MM KITCHEN PLINTH 1	£49.72	WG2/LEPAN2	2400X700MM LARDER END PANEL 8	£124.48
WG2/BPLINTH	2650X100MM BEDROOM PLINTH 2	£49.72	WG2/FLY1	1200X300MM FLYSHELF PANEL 9	£48.44
WG2/WPAN	720X350MM WALL END PANEL 4	£40.08	WG2/FLY2	320X2400MM FLYSHELF PANEL 10	£72.84
WG2/WPAN2	760X350MM WALL END PANEL 5	£40.08	WG2/BBAR1	950X1200MM BREAKFAST BAR PANEL 11	£97.28
WG2/TWPAN	900X350MM TALL WALL END PANEL 3	£43.92	WG2/BBAR2	950X2400MM BREAKFAST BAR PANEL 12	£174.56
WG2/BPAN	950X650MM BASE END PANEL 13	£63.84	WG2/BBS	950X610MM BREAKFAST BAR SIDE 6	£61.28

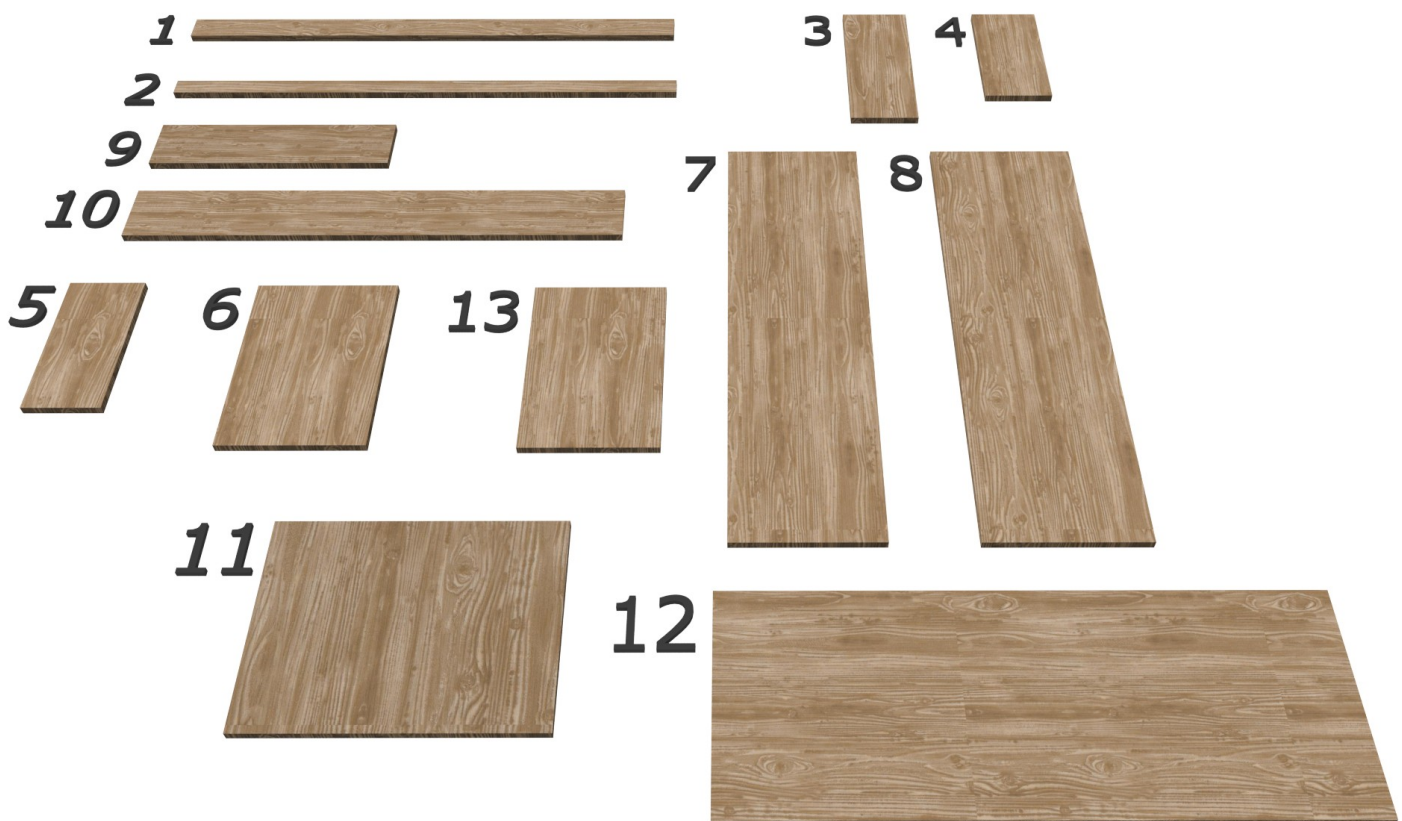

PIATTO SENSE GLOSS & MATTE



Piatto Sense is a slab style door manufactured using high grade lacquered MDF edged using a durable ABS colour matched edging. All our Piatto doors are edged using a PUR gluing system, making this range the most hardwearing and moisture resistant range we offer.

PIATTO SENSE GLOSS COLOURS



GRAPHITE GREY



DUST GREY

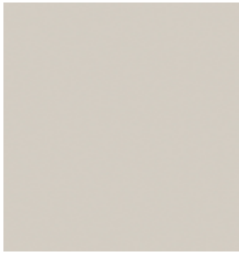

LIGHT GREY



CASHMERE GREY

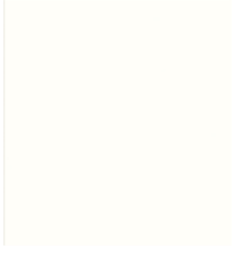

ALPINE WHITE

PIATTO SENSE MATTE COLOURS



GRAPHITE GREY



DUST GREY

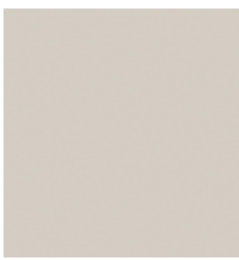

LIGHT GREY



INDIGO BLUE



ALPINE WHITE

SIZE	PRICE £	SIZE	PRICE £	SIZE	PRICE £
110X595 BLANK	£13.28	283X995 DOOR	£24.08	715X395 DOOR	£24.12
120X495 DRAWER	£12.98	325X495 DOOR	£18.04	715X445 DOOR	£25.90
120X595 DRAWER	£13.58	325X595 DOOR	£19.66	715X495 DOOR	£27.70
120X695 DRAWER	£14.18	325X795 DOOR	£22.92	715X545 DOOR	£29.48
120X795 DRAWER	£14.78	325X895 DOOR	£24.54	715X595 DOOR	£31.92
120X895 DRAWER	£15.38	325X995 DOOR	£26.16	895X295 DOOR	£23.20
120X995 DRAWER	£15.98	355X295 DOOR	£15.24	895X395 DOOR	£27.68
140X295 DRAWER	£12.06	355X495 DOOR	£18.78	895X445 DOOR	£29.92
140X395 DRAWER	£12.76	355X595 DOOR	£20.56	895X495 DOOR	£33.24
140X445 DRAWER	£13.12	355X795 DOOR	£24.12	895X595 DOOR	£39.94
140X495 DRAWER	£13.46	355X895 DOOR	£25.88	980X595 DOOR	£43.74
140X595 DRAWER	£14.16	355X995 DOOR	£27.66	1245X295 DOOR	£28.36
140X795 DRAWER	£15.56	450X595 DOOR	£23.38	1245X395 DOOR	£36.88
140X895 DRAWER	£16.26	490X595 DOOR	£24.58	1245X445 DOOR	£41.56
140X995 DRAWER	£16.96	570X295 DOOR	£18.40	1245X595 DOOR	£55.56
160X495 DRAWER	£13.96	570X395 DOOR	£21.26	1795X345 DOOR	£46.44
160X595 DRAWER	£14.76	570X445 DOOR	£22.68	1795X395 DOOR	£53.20
160X795 DRAWER	£16.36	570X495 DOOR	£24.10	1795X445 DOOR	£59.92
160X895 DRAWER	£17.16	570X595 DOOR	£27.16	1795X495 DOOR	£66.64
160X995 DRAWER	£17.96	645X595 DOOR	£29.18	1795X595 DOOR	£80.10
175X395 DRAWER	£13.46	685X145 DOOR	£14.96	1965X295 DOOR	£43.48
175X495 DRAWER	£14.34	685X295 DOOR	£20.10	1965X395 DOOR	£58.20
175X595 DRAWER	£15.20	685X345 DOOR	£21.82	1965X495 DOOR	£72.90
245X495 DRAWER	£16.06	685X395 DOOR	£23.52	1965X595 DOOR	£87.70
245X595 DRAWER	£17.28	685X445 DOOR	£25.24	2145X295 DOOR	£47.56
245X695 DRAWER	£18.52	685X495 DOOR	£26.96	2145X395 DOOR	£63.54
245X795 DRAWER	£19.74	685X545 DOOR	£28.66	2145X495 DOOR	£79.62
245X895 DRAWER	£20.96	685X595 DOOR	£30.58	2145X595 DOOR	£95.74
245X995 DRAWER	£22.18	715X145 DOOR	£15.18	2295X345 DOOR	£59.38
283X495 DOOR	£17.00	715X255 DOOR	£19.12	2295X395 DOOR	£67.98
283X595 DOOR	£18.42	715X295 DOOR	£20.54	2295X445 DOOR	£76.60
283X795 DOOR	£21.24	715X313 DOOR	£21.18	2295X495 DOOR	£85.20
283X895 DOOR	£22.66	715X345 DOOR	£22.34	2295X545 DOOR	£93.82
MATCHING ACCESSORIES (MELAMINE PANELS)				2295X595 DOOR	£102.42
STOCK CODE	DESCRIPTION	PRICE	CODE	DESCRIPTION	PRICE
PS/CORNICE	2100X38MM CORNICE 2	£60.00	PS/LEPAN	2400X650MM LARDER END PANEL 7	£117.00
PS/PLINTH	2650X150MM KITCHEN PLINTH 1	£29.88	PS/LEPAN2	2400X700MM LARDER END PANEL 8	£126.00
PS/BPLINTH	2650X100MM BEDROOM PLINTH 2	£23.26	PS/FLY1	1200X300MM FLYSHELF PANEL 9	£28.00
PS/WPAN	720X350MM WALL END PANEL 4	£22.60	PS/FLY2	320X2400MM FLYSHELF PANEL 10	£57.60
PS/WPAN2	760X350MM WALL END PANEL 5	£23.30	PS/BBAR1	950X1200MM BREAKFAST BAR PANEL 11	£85.50
PS/TWPAN	900X350MM TALL WALL END PANEL 3	£25.76	PS/BBAR2	950X2400MM BREAKFAST BAR PANEL 12	£171.00
PS/BPAN	950X650MM BASE END PANEL 13	£46.32	PS/BBS	950X610MM BREAKFAST BAR SIDE 6	£43.48

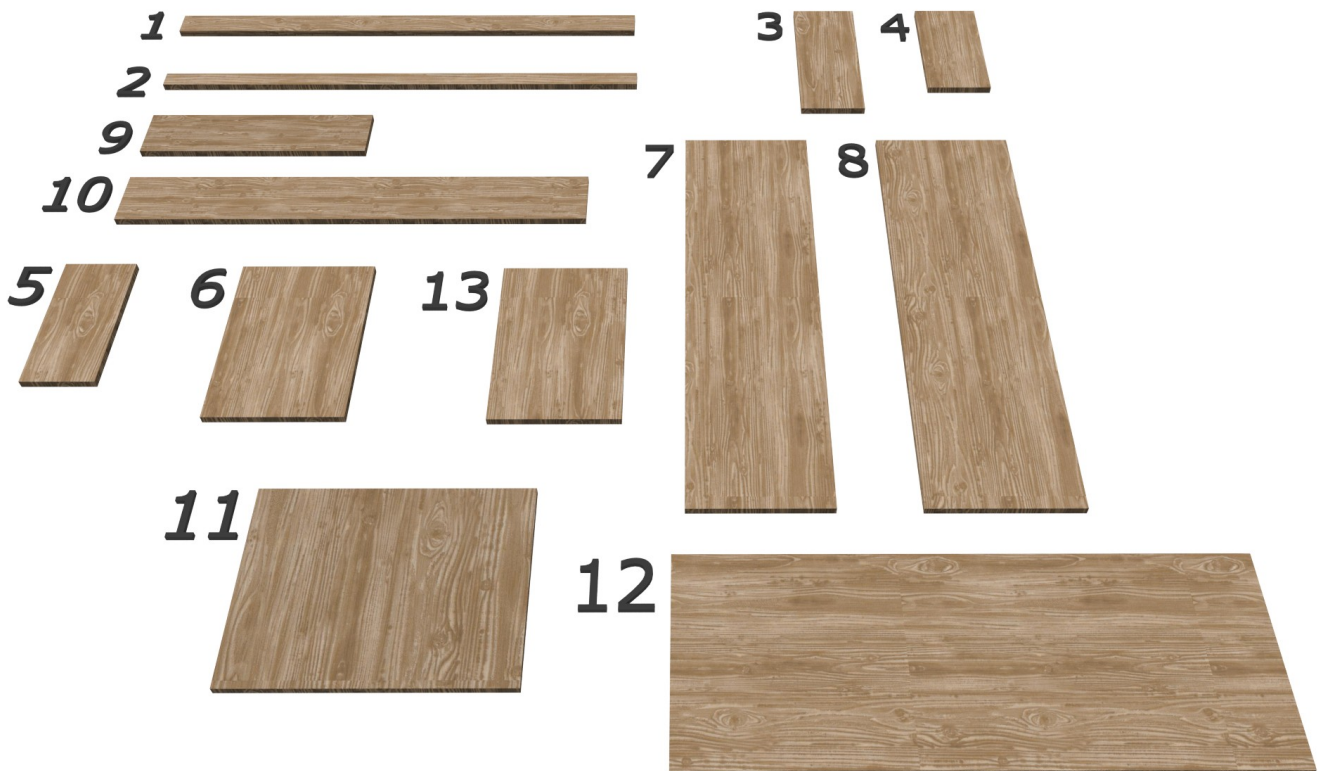

Sliding Bedroom Door System

FULL PANEL

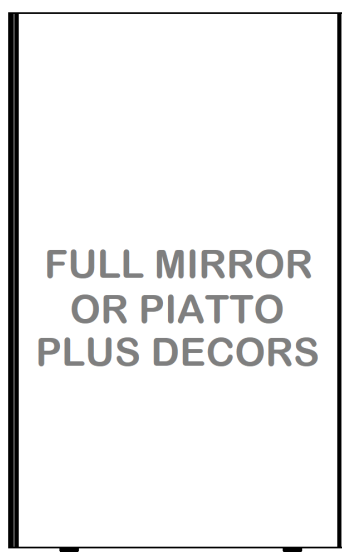

3 PANELS EQUAL SPLIT

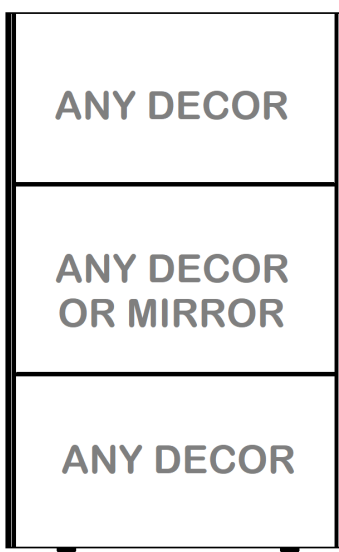

3 PANELS 350mm HIGH CENTRE

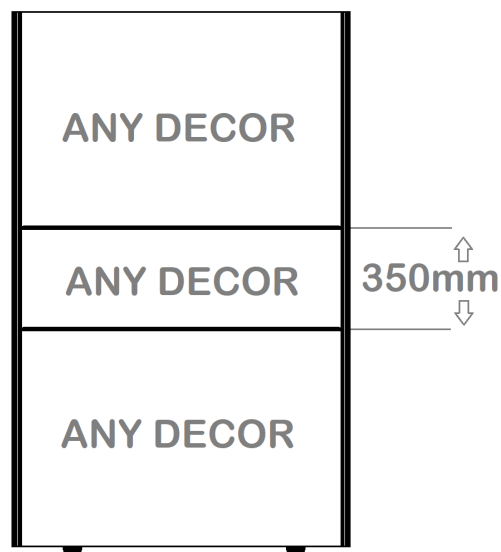

Our sliding door systems can be made to ANY SIZE, the maximum height is 2400mm, and the maximum width is 1000mm PER DOOR. A sliding door system of runs over 4000mm will have a join in the upper and lower tracks.

We can make sliding doors on their own to suit your own opening sizes, or make them to suit our wardrobe cabinets.

FULL PANEL doors are available in PIATTO PLUS decors and mirrors only.

3 EQUAL PANEL doors are available in any PIATTO PLUS or PIATTO SENSE decors, we also have an option for a mirror to be fitted in the CENTRE panel only. Each panel would be made with a vertical grain as standard, unless specified otherwise.

3 PANEL 350mm CENTRE doors are available in any PIATTO PLUS or PIATTO SENSE decors, the centre panel will be 350mm High and have a horizontal grain as standard. The top and bottom panels will be split in equal sizes and have a vertical grain as standard, unless specified otherwise.

All our sliding doors are priced complete with both top & bottom tracks and soft closing system on one side only, soft close can be added to the opening side at an additional cost - CODE SWD/SC - £10.00.

Stock Code	Description	Price
SINGLE FULL SLIDING DOORS		
SWD/FP/PP	SLIDING WARDROBE DOOR WITH FULL PANEL PIATTO PLUS DECOR	£160.00
SWD/FP/MR	SLIDING WARDROBE DOOR WITH FULL PANEL WITH FULL MIRROR	£340.00
3 EQUAL PANEL SPLIT SLIDING DOORS		
SWD/3E/PP	SLIDING WARDROBE DOOR WITH 3 EQUAL PANELS PIATTO PLUS	£164.00
SWD/3E/PS	SLIDING WARDROBE DOOR WITH 3 EQUAL PANELS PIATTO SENSE	£232.00
SWD/3E/PP/M	SLIDING WARDROBE DOOR WITH 3 PANELS PIATTO PLUS & MIRROR	£244.00
SWD/3E/PS/M	SLIDING WARDROBE DOOR WITH 3 PANELS PIATTO SENSE & MIRROR	£312.00
3 PANEL SPLIT SLIDING DOORS – 350mm HIGH CENTRE PANEL		
SWD/3P/PP	3 PANEL SPLIT SLIDING DOORS – 350mm CENTRE PIATTO PLUS	£164.00
SWD/3P/PS	3 PANEL SPLIT SLIDING DOORS – 350mm CENTRE PIATTO SENSE	£232.00

WARDROBE CABINETS:- IMPORTANT INFORMATION

- All wardrobe cabinets are available 400mm to 600mm wide in single door options, or 700mm to 1000mm wide in double door options.
- All single and double wardrobes are available in 3 options which are illustrated below, please state which option you require when ordering. The option you have chosen will show in the NOTES section of your order form.
- Wardrobes with drawers are available in selected widths between 500mm & 1000mm, please see price guide for availability.
- Wardrobes with drawers will only have a fixed shelf in the top section if 2100mm high or above.
- All our wardrobe cabinets are 600mm deep; this is the minimum depth you will need for clothes to fit on a hanging rail.
- When using sliding doors all wardrobes will be 680mm deep (including doors & frame). The top and bottom panels of each cabinet will overhang by 60mm to accommodate the door tracks.
- All our wardrobes are 2300mm High not including plinths or scribe panels, the height can be reduced if required. Please ensure you reduce the door height by the same measurement the cabinet has been reduced by.
- All wardrobes are delivered flat packed to ensure they will get up stairways etc. Bedside & drawer units are delivered assembled, fascias and handles will still require installation.

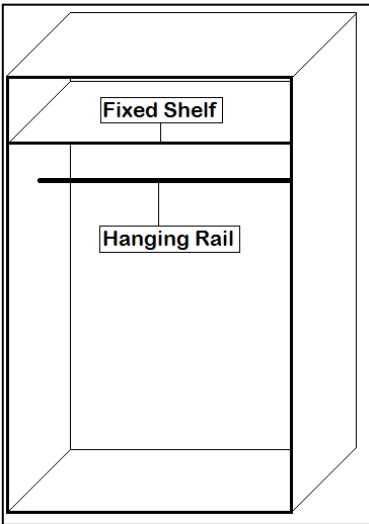
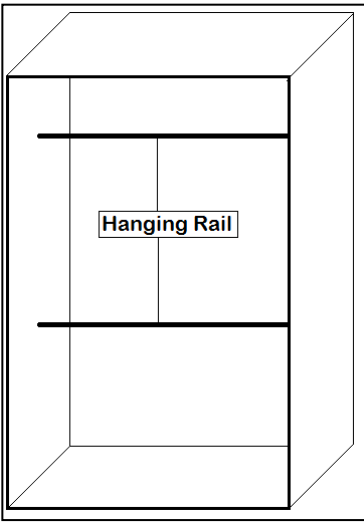
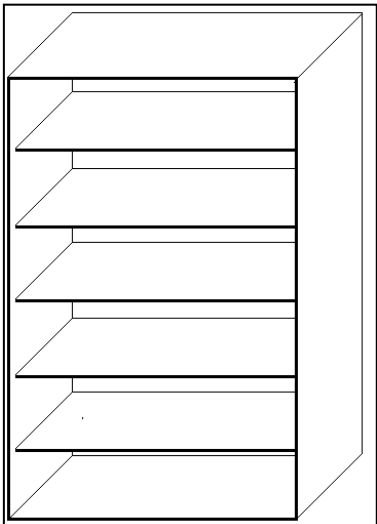
OPTION 1 SINGLE HANGING RAIL	OPTION 2 DOUBLE HANGING RAIL	OPTION 3 5 x ADJUSTABLE SHELVES
		
<p>A wardrobe with a single hanging rail has 1 X hanging rail supplied and has a FIXED shelf supplied 400mm from the top of the unit. Unless another option is specified, this option will be supplied as standard.</p>	<p>A wardrobe with a double hanging rail has 2 X hanging rails supplied only and no shelving is supplied with the unit. It is not recommended to fit a double hanging rail in wardrobes with drawers in the bottom.</p>	<p>A wardrobe with adjustable shelving is supplied 5 adjustable shelves (570mm deep) that can be positioned at the required heights using the shelf supports provided.</p>

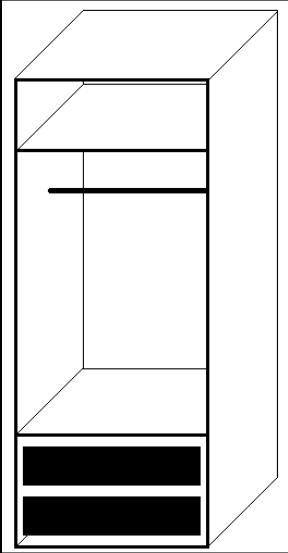
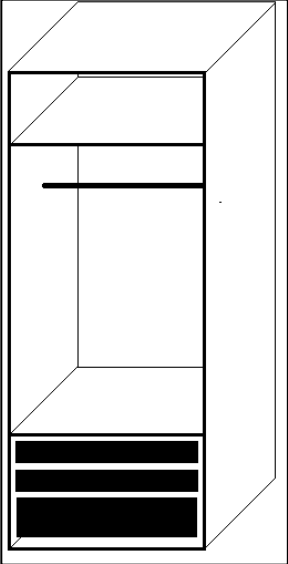
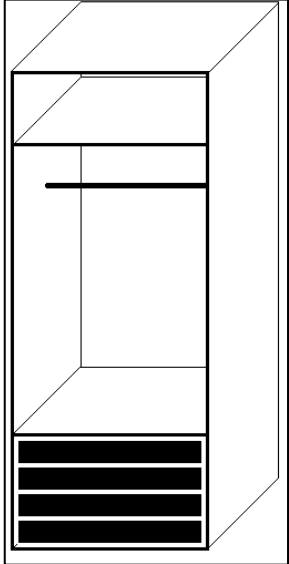
WARDROBE DRAWER OPTIONS		
2 DRAWER WARDROBE	3 DRAWER WARDROBE	4 DRAWER WARDROBE
		
<p>Wardrobes with drawers will only have a fixed shelf in the top section if 2100mm high or above. Drawers and fascias on double door wardrobes will be the full width of the cabinet. Wardrobes with drawers will need internal drawer fronts to be ordered extra when used with sliding doors</p>		

Single Door Wardrobes

SINGLE DOOR WARDROBES FULL HEIGHT DOORS						
DESCRIPTION			CODE	WH	WG	WG2
SINGLE WARDROBE 600MM UPTO 2300H			SR600	£318.68	£399.84	£523.08
Width:- 600mm	Depth:- 600mm	Height: 2300mm	Requires 1 x 2295 x 595			
SINGLE WARDROBE 550MM UPTO 2300H			SR550	£318.68	£399.84	£523.08
Width:- 550mm	Depth:- 600mm	Height: 2300mm	Requires 1 x 2295 x 545			
SINGLE WARDROBE 500MM UPTO 2300H			SR500	£318.68	£399.84	£523.08
Width:- 500mm	Depth:- 600mm	Height: 2300mm	Requires 1 x 2295 x 495			
SINGLE WARDROBE 450MM UPTO 2300H			SR450	£318.68	£399.84	£523.08
Width:- 450mm	Depth:- 600mm	Height: 2300mm	Requires 1 x 2295 x 445			
SINGLE WARDROBE 400MM UPTO 2300H			SR400	£318.68	£399.84	£523.08
Width:- 450mm	Depth:- 600mm	Height: 2300mm	Requires 1 x 2295 x 395			
SINGLE DOOR WARDROBES WITH DRAWERS						
SINGLE 2 DRAWER WARDROBE 600MM UP TO 2300H			SRD600	£602.68	£683.84	£807.08
Width:- 600mm	Depth:- 600mm	Height: 2300mm	Requires 1 x 1795 x 595 & 2 x 245 x 595			
SINGLE 2 DRAWER WARDROBE 500MM UP TO 2300H			SRD500	£602.68	£683.84	£807.08
Width:- 500mm	Depth:- 600mm	Height: 2300mm	Requires 1 x 1795 x 495 & 2 x 245 x 495			
SINGLE 3 DRAWER WARDROBE 600MM UP TO 2300H			SR3D600	£636.68	£717.84	£841.08
Width:- 600mm	Depth:- 600mm	Height: 2300mm	Requires 1 x 1795 x 595, 1 x 245 x 595, 2 x 120 x 595			
SINGLE 3 DRAWER WARDROBE 500MM UP TO 2300H			SR3D500	£636.68	£717.84	£841.08
Width:- 500mm	Depth:- 600mm	Height: 2300mm	Requires 1 x 1795 x 495, 1 x 245 x 495, 2 x 120 x 495			
SINGLE 4 DRAWER WARDROBE 600MM UP TO 2300H			SR4D600	£706.68	£787.84	£911.08
Width:- 600mm	Depth:- 600mm	Height: 2300mm	Requires 1 x 1795 x 595, 4 x 120 x 595			
SINGLE 4 DRAWER WARDROBE 500MM UP TO 2300H			SR4D500	£706.68	£787.84	£911.08
Width:- 500mm	Depth:- 600mm	Height: 2300mm	Requires 1 x 1795 x 495 & 4 x 120 x 495			

Double Door Wardrobes

DOUBLE DOOR WARDROBES FULL HEIGHT DOORS						
DESCRIPTION			CODE	WH	WG	WG2
DOUBLE WARDROBE 1000MM UPTO 2300H			SR100	£421.68	£542.36	£725.64
Width: 1000mm	Depth:- 600mm	Height: 2300mm	Requires 2 x 2295 x 495			
DOUBLE WARDROBE 900MM UPTO 2300H			SR900	£421.68	£542.36	£725.64
Width:- 900mm	Depth:- 600mm	Height: 2300mm	Requires 2 x 2295 x 445			
DOUBLE WARDROBE 800MM UPTO 2300H			SR800	£421.68	£542.36	£725.64
Width:- 800mm	Depth:- 600mm	Height: 2300mm	Requires 2 x 2295 x 395			
DOUBLE WARDROBE 700MM UPTO 2300H			SR700	£421.68	£542.36	£725.64
Width:- 700mm	Depth:- 600mm	Height: 2300mm	Requires 2 x 2295 x 345			
DOUBLE DOOR WARDROBES WITH DRAWERS						
DOUBLE 2 DRAWER WARDROBE 1000MM UP TO2300H			SRD100	£685.68	£806.36	£989.64
Width: 1000mm	Depth:- 600mm	Height: 2300mm	Requires 2 x 1795 x 495 & 2 x 245 x 995			
DOUBLE 2 DRAWER WARDROBE 900MM UP TO2300H			SRD900	£685.68	£806.36	£989.64
Width: 900mm	Depth:- 600mm	Height: 2300mm	Requires 2 x 1795 x 445 & 2 x 245 x 895			
DOUBLE 2 DRAWER WARDROBE 800MM UP TO2300H			SRD800	£685.68	£806.36	£989.64
Width: 800mm	Depth:- 600mm	Height: 2300mm	Requires 2 x 1795 x 395, 2 x 245 x 795			
DOUBLE 2 DRAWER WARDROBE 700MM UP TO2300H			SRD700	£685.68	£806.36	£989.64
Width: 700mm	Depth:- 600mm	Height: 2300mm	Requires 2 x 1795 x 345, 2 x 245 x 695			
DOUBLE 3 DRAWER WARDROBE 1000MM x 2300H			SR3D100	£719.68	£840.36	£1023.64
Width: 1000mm	Depth:- 600mm	Height: 2300mm	Requires 2 x 1795 x 495, 1 x 245 x 995, 2 x 120 x 995			
DOUBLE 3 DRAWER WARDROBE 900MM x 2300H			SR3D900	£719.68	£840.36	£1023.64
Width:- 900mm	Depth:- 600mm	Height: 2300mm	Requires 2 x 1795 x 445, 1 x 245 x 895, 2 x 120 x 895			
DOUBLE 3 DRAWER WARDROBE 800MM x 2300H			SR3D800	£719.68	£840.36	£1023.64
Width:- 800mm	Depth:- 600mm	Height: 2300mm	Requires 2 x 1795 x 395, 1 x 245 x 795, 2 x 120 x 795			
DOUBLE 3 DRAWER WARDROBE 700MM x 2300H			SR3D700	£719.68	£840.36	£1023.64
Width:- 700mm	Depth:- 600mm	Height: 2300mm	Requires 2 x 1795 x 345, 1 x 245 x 695, 2 x 120 x 695			
DOUBLE 4 DRAWER WARDROBE 1000MM x 2300H			SR4D100	£789.68	£910.36	£1073.64
Width: 1000mm	Depth:- 600mm	Height: 2300mm	Requires 2 x 1795 x 495, 4 x 120 x 995			
DOUBLE 4 DRAWER WARDROBE 900MM x 2300H			SR4D900	£789.68	£910.36	£1073.64
Width:- 900mm	Depth:- 600mm	Height: 2300mm	Requires 2 x 1795 x 445, 4 x 120 x 895			
DOUBLE 4 DRAWER WARDROBE 800MM x 2300H			SR4D800	£789.68	£910.39	£1073.64
Width:- 800mm	Depth:- 600mm	Height: 2300mm	Requires 2 x 1795 x 395, 4 x 120 x 795			
DOUBLE 4 DRAWER WARDROBE 700MM x 2300H			SR4D700	£789.68	£910.36	£1073.64
Width:- 700mm	Depth:- 600mm	Height: 2300mm	Requires 2 x 1795 x 345, 4 x 120 x 695			

Bedside Cabinets

BEDSIDE CABINETS			
<p>BEDSIDE CABINETS</p> <p>GLOSS & VINYL RANGES:-</p> <p>A CLADDING PACK CAN BE USED TO COVER BOTH SIDES OF THE CABINET. ALSO INCLUDES A COUNTER TOP. PLEASE NOTE THIS WILL ADD 40mm TO THE TOTAL CABINET WIDTH,</p>	<p>All 510MM WIDE x 520MM DEEP as standard, options 1 & 2 also available as a micro cabinet 310MM WIDE x 320MM DEEP. (Also available in custom sizes)</p>		
	<p>1</p> <p>140H OPEN SHELF SPACE</p> <p>355H DOOR</p> <p>50mm plinth</p>	<p>2</p> <p>140H DRAWER</p> <p>355H DOOR</p> <p>50mm plinth</p>	<p>3</p> <p>245H DRAWER</p> <p>245H DRAWER</p> <p>50mm plinth</p>

DESCRIPTION			CODE	WH	WG	WG2
MICRO BEDSIDE CABINET 310WX320D(DOOR/OPEN SHELF)			BS/MIOPT1	£186.16	£196.92	£213.32
Width:- 300mm	Depth:- 300mm	Height: 555mm	Requires 1 X 355 X 295			
MICRO BEDSIDE CABINET310WX320D(DOOR/DRAWER)			BS/MIOPT2	£260.16	£270.92	£287.32
Width:- 300mm	Depth:- 300mm	Height: 555mm	Requires 1 X 355 X 295 & 1 X 140 X 295			
BEDSIDE CABINET 510W OPT1 (DOOR/OPEN SHELF)			BS/OPT1	£201.76	£221.64	£251.88
Width:- 500mm	Depth:- 500mm	Height: 555mm	Requires 1 X 355 X 495			
BEDSIDE CABINET 510W OPT2 (DOOR/DRAWER)			BS/OPT2	£275.76	£295.64	£325.88
Width:- 500mm	Depth:- 500mm	Height: 555mm	Requires 1 X 355 X 495 & 1 X 140 X 495			
BEDSIDE CABINET 510W OPT3 (2XDRAWER)			BS/OPT3	£418.08	£437.96	£468.20
Width:- 500mm	Depth:- 500mm	Height: 555mm	Requires 2 X 245 X 495			
Please see matching accessories section of your chosen range for matching end panels, tops & plinths.						

DRAWER CHEST CABINETS

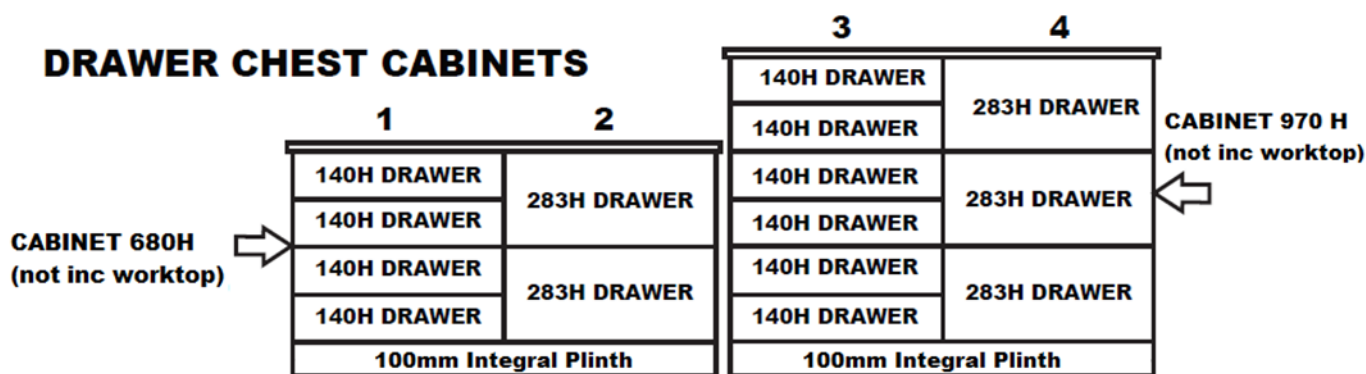

1. 4 Drawer Chest 300MM WIDE to 1000MM WIDE x 520MM DEEP
2. 2 Drawer Chest 500MM WIDE to 1000MM WIDE x 520MM DEEP
3. 6 Drawer Chest 300MM WIDE to 1000MM WIDE x 520MM DEEP
4. 3 Drawer Chest 500MM WIDE to 1000MM WIDE x 520MM DEEP

(OPTIONS 1 & 2 CAN BE USED TO FORM DRESSING TABLES)

Drawer Chest Cabinets 680H

DESCRIPTION			CODE	WH	WG	WG2
4 DRAWER CHEST UNIT 300W X 680H X 520D			DC/OPT1300	£544.40	£565.68	£598.00
Width:- 300mm	Depth:- 500mm	Height: 680mm	Requires 4 X 140 X 295			
4 DRAWER CHEST UNIT 400W X 680H X 520D			DC/OPT1400	£547.80	£571.04	£606.36
Width:- 400mm	Depth:- 500mm	Height: 680mm	Requires 4 X 140 X 395			
4 DRAWER CHEST UNIT 500W X 680H X 520D			DC/OPT1500	£551.16	£576.40	£614.72
Width:- 500mm	Depth:- 500mm	Height: 680mm	Requires 4 X 140 X 495			
4 DRAWER CHEST UNIT 600W X 680H X 520D			DC/OPT1600	£554.56	£581.76	£628.08
Width:- 600mm	Depth:- 500mm	Height: 680mm	Requires 4 X 140 X 595			
4 DRAWER CHEST UNIT 800W X 680H X 520D			DC/OPT1800	£552.72	£578.88	£618.56
Width:- 800mm	Depth:- 500mm	Height: 680mm	Requires 4 X 140 X 795			
4 DRAWER CHEST UNIT 1000W X 680H X 520D			DC/OPT1100	£559.48	£589.56	£685.28
Width: 1000mm	Depth:- 500mm	Height: 680mm	Requires 4 X 140 X 995			
2 DRAWER CHEST UNIT 300W X 680H X 520D			DC/OPT2300	£480.40	£501.68	£534.00
Width:- 300mm	Depth:- 500mm	Height: 680mm	Requires 2 X 283 X 295			
2 DRAWER CHEST UNIT 400W X 680H X 520D			DC/OPT2400	£507.80	£507.04	£542.36
Width:- 400mm	Depth:- 500mm	Height: 680mm	Requires 2 X 283 X 395			
2 DRAWER CHEST UNIT 500W X 680H X 520D			DC/OPT2500	£487.16	£512.40	£550.72
Width:- 500mm	Depth:- 500mm	Height: 680mm	Requires 2 X 283 X 495			
2 DRAWER CHEST UNIT 600W X 680H X 520D			DC/OPT2600	£490.56	£517.76	£559.08
Width:- 600mm	Depth:- 500mm	Height: 680mm	Requires 2 X 283 X 595			
2 DRAWER CHEST UNIT 800W X 680H X 520D			DC/OPT2800	£488.72	£514.88	£554.56
Width:- 800mm	Depth:- 500mm	Height: 680mm	Requires 2 X 283 X 795			
2 DRAWER CHEST UNIT 1000W X 680H X 520D			DC/OPT2100	£495.48	£527.16	£571.28
Width: 1000mm	Depth:- 500mm	Height: 680mm	Requires 2 X 283 X 995			

Drawer Chest Cabinets 970H

DESCRIPTION			CODE	WH	WG	WG2
6 DRAWER CHEST UNIT 300W X 970H X 520D			DC/OPT3300	£701.44	£723.32	£756.56
Width:- 300mm	Depth:- 500mm	Height: 970mm	Requires 6 X 140 X 295			
6 DRAWER CHEST UNIT 400W X 970H X 520D			DC/OPT3400	£705.36	£729.52	£766.20
Width:- 400mm	Depth:- 500mm	Height: 970mm	Requires 6 X 140 X 395			
6 DRAWER CHEST UNIT 500W X 970H X 520D			DC/OPT3500	£709.52	£736.12	£776.48
Width:- 500mm	Depth:- 500mm	Height: 970mm	Requires 6 X 140 X 495			
6 DRAWER CHEST UNIT 600W X 970H X 520D			DC/OPT3600	£713.68	£742.68	£786.76
Width:- 600mm	Depth:- 500mm	Height: 970mm	Requires 6 X 140 X 595			
6 DRAWER CHEST UNIT 800W X 970H X 520D			DC/OPT3800	£722.00	£755.88	£807.36
Width:- 800mm	Depth:- 500mm	Height: 970mm	Requires 6 X 140 X 795			
6 DRAWER CHEST UNIT 1000W X 970H X 520D			DC/OPT3100	£730.32	£769.08	827.93
Width: 1000mm	Depth:- 500mm	Height: 970mm	Requires 6 X 140 X 995			
3 DRAWER CHEST UNIT 300W X 970H X 520D			DC/OPT4300	£597.44	£621.32	£654.56
Width:- 300mm	Depth:- 500mm	Height: 970mm	Requires 3 X 283 X 295			
3 DRAWER CHEST UNIT 400W X 970H X 520D			DC/OPT4400	£603.36	£627.52	£664.20
Width:- 400mm	Depth:- 500mm	Height: 970mm	Requires 3 X 283 X 395			
3 DRAWER CHEST UNIT 500W X 970H X 520D			DC/OPT4500	£607.52	£634.12	£674.48
Width:- 500mm	Depth:- 500mm	Height: 970mm	Requires 3 X 283 X 495			
3 DRAWER CHEST UNIT 600W X 970H X 520D			DC/OPT4600	£611.68	£640.72	£684.76
Width:- 600mm	Depth:- 500mm	Height: 970mm	Requires 3 X 283 X 595			
3 DRAWER CHEST UNIT 800W X 970H X 520D			DC/OPT4800	£662.00	£653.88	£705.36
Width:- 800mm	Depth:- 500mm	Height: 970mm	Requires 3 X 283 X 795			
3 DRAWER CHEST UNIT 1000W X 970H X 520D			DC/OPT4100	£628.32	£667.08	£725.92
Width: 1000mm	Depth:- 500mm	Height: 970mm	Requires 3 X 283 X 995			

A FEW TIPS WHEN ORDERING & PLANNING BEDROOM FURNITURE.

1. Bedside cabinets are supplied with an MFC worktop panel in the matching décor to the cabinet. If your door range is not a perfect match for the cabinet colour or material you have chosen you will need to order additional panels from the matching accessory section of your chosen range / door style. You may also need to order clad on end panels for exposed sides also, if you do, then remember to order your worktop panel bigger to accommodate your end panels. This also applies to drawer chest cabinets except we do not supply any work surface as standard, you must order them from the matching accessory or the melamine panel price list.
2. When ordering our bedroom cabinets for our sliding door systems you do not need to build up any kind of framework. We will make your cabinets with a 60mm overhang to both the top and bottom of the wardrobe. This allows you to screw the tracks directly to the cabinet. You will need to allow an end panel to each side of any run of wardrobes, this is so the sliding doors have something to close onto. If any side is up to a wall a plinth could be used to save on cost. Please be aware that sliding door systems will add a total of 80mm to the finished depth of any wardrobes once the plinths and scribe panels have been installed.
3. When ordering a bedroom with sliding doors it is also important to ensure all the cabinets in any particular run are all of equal widths, otherwise this will cause problems with accessing the cabinets behind the doors.
4. Our kitchen cabinets can also be used when designing or ordering a bedroom. Many customers use wall cabinets and bridging units within a design. These units can also be made deeper or shallower that usual to accommodate your requirements.
5. Fitted bedroom furniture will always be scribed into your walls using a filler panel, these panels are normally between 30 – 50mm. Plinths at the bottom of wardrobes are 100mm and ceiling scribe panels are between 50 – 80mm. Ceiling heights above 2450 will have scribe panels larger, if you do not want a larger scribe panel then consider not having one at all, using a cornice or adding more units above. Plinths are the most ideal panel to order for scribing panels, and in most cases 1 plinth will be enough to make 2 scribes.
6. All wardrobes are as standard 2300mm high, this is the highest we can make any wardrobe. If you require wardrobes higher then additional units can be placed above or below the wardrobes (eg:- bridging units from our kitchen range made deeper). Wardrobes can be reduced in height on request. **FOR CEILING HEIGHTS ABOVE 2450mm OR CEILINGS WITH LARGE ORNATE COVING PLEASE CONSIDER HOW YOUR WARDROBES WILL MEET THE CEILING ABOVE.**

HETTICH CONCEALED HINGES (PAIRS)



HINGES AS PAIRS COMPLETE WITH HINGE PLATES		
HP110/SC	PAIR OF 110 DEG SOFT CLOSE HINGES INC PLATE	£4.28
HP110/NS	PAIR OF 110 DEG NON SOFT CLOSE HINGES INC PLATE	£3.26
HP165/SC	PAIR OF 165 DEG SOFT CLOSE HINGES INC PLATE	£8.40
HP165/NS	PAIR OF 165 DEG NON SOFT CLOSE HINGES INC PLATE	£6.32
HP90	PAIR OF BI-FOLD 90 DEG HINGES AND PLATE FOR 905 CORNER	£5.71
HP45/SC	PAIR OF SOFT CLOSE 45 DEG HINGES INC PLATE	£9.63
HP110/IF	PAIR OF 110 DEG CRANKED HINGE FOR IN FRAME INC PLATE	£6.53

CABINET FITTINGS AND COMPONENTS

CODE	DESCRIPTION	PRICE
CP001	SOFT CLOSE HINGE PLATE (EACH)	£0.45
CP002	SOFT CLOSE 110 DEG HINGE (EACH)	£1.73
CP003	NON SOFT CLOSE 110 DEG HING (EACH)	£1.20
CP004	SOFT CLOSE 165 DEG HINGE (EACH)	£3.77
CP005	NON SOFT CLOSE 165 DEG HINGE (EACH)	£2.73
CP006	BI- FOLD 90 DEG HINGE FOR 905 CORNER (EACH)	£2.43
CP007	FACE FIXING HINGE PLATE FOR 905 CORNER (EACH)	£0.46
CP008	SOFT CLOSE 45 DEG HINGE (EACH)	£4.40
CP009	CRANKED 110 DEG HINGE FOR IN FRAME (EACH)	£2.40
CP010	IN FRAME HINGE PLATE (EACH)	£0.92
CP011(A)	PUSH TO OPEN HINGE SYSTEM X2 HINGE 1 PTO SYSTEM	£9.00
CP011(B)	PUSH TO OPEN SYSTEM FOR DRAWER	£6.00
CP012	500MM X 1210MM TAMBOUR DOOR SYSTEM	£163.18
CP013	600MM X 1210MM TAMBOUR DOOR SYSTEM	£191.90
CP014	BI-FOLD GAS LIFT SYSTEM UPTO 600MM (EACH)	£75.26
CP015	BI-FOLD GAS LIFT SYSTEM UPTO 1000MM (EACH)	£81.88
CP016	METAL L BRACKET 19X19MM (EACH)	£0.05
CP017	STRAIGHT FIXING PLATE (EACH)	£0.25
CP018	PACK OF 4 CABINET LEGS 150MM	£1.20
CP019	PAIR OF 400MM GLASS SHELVES	£17.60
CP020	PAIR OF 500MM GLASS SHELVES	£21.52
CP021	PAIR OF 600MM GLASS SHELVES	£12.76
CP022	870MM CHROME POST (EACH)	£15.30
CP023	710MM CHROME POST (EACH)	£15.04
CP024	5MM TRANSLUCENT SHELF PIN SET OF 4	£0.20
CP024G	5MM SHELF PIN FOR GLASS SHELVES SERT OF 4	£0.40
CP025L	CAMAR WALL HANGING SYSTEM LEFT (EACH)	£0.75
CP025R	CAMAR WALL HANGING SYSTEM RIGHT (EACH)	£0.75
CP026L	CAMAR WALL HANGING COVER LEFT (EACH)	£0.30
CP026R	CAMAR WALL HANGING COVER RIGHT (EACH)	£0.30
CP027	WALL PLATES (PAIR)	£0.08

CODE	DESCRIPTION	PRICE
CP028	GAS LIFT BRIDGING STAY 80N (EACH)	£2.00
CP029	GAS LIFT BRIDGING STAY 60N (EACH)	£2.00
CP030	CAM METAL DOWEL (EACH)	£0.05
CP031	CAM LOCK (EACH)	£0.06
CP032	WOODEN DOWEL 6X24MM (EACH)	£0.02
CP033	MODISTY BLOCK WHITE (EACH)	£0.04
CP033/B	MODISTY BLOCK BLACK (EACH)	£0.04
CP034	MODISTY BLOCK CREAM (EACH)	£0.05
CP035	MODISTY BLOCK BROWN (EACH)	£0.05
CP036	SELF ADHESIVE RUBBER BUFFER SET OF 100	£2.00
CP037	PAIR OF HINGE CAPS WHITE	£0.08
CP038	PAIR OF HINGE CAPS CREAM	£0.16
CP039	BOX OF 200 16MM X 3.5 SCREWS	£1.20
CP040	BOX OF 200 20MM X 3.5 SCREWS	£1.30
CP041	BOX OF 200 25MM X 3.5 SCREWS	£1.24
CP042	BOX OF 200 30MM X 3.5 SCREWS	£1.50
CP043	BOX OF 200 40MM X 3.5 SCREWS	£2.10
CP044	WORKTOP FIXING BOLTS SET OF 3	£0.20
CP045	1M WARDROBE RAIL CHROME (EACH)	£2.00
CP046	WARDROBE RAIL MID SUPPORT (EACH)	£0.66
CP047	WARDROBE RAIL PAIR OF END SUPPORTS	£0.35
CP048	150MM CHROME WINE RACK INSERT (EACH)	£79.68
CP049	300MM CHROME WINE RACK INSERT (EACH)	£117.92
CP063	300MM STANDARD INTERNAL DRAWER FRONT	£13.06

HETTICH ARCITECH DRAWER BOXES

DRAWER BOX COMPLETE WITH RUNNERS & FIXINGS, INTERNAL DRAWER FRONTS		
DR/STAN300	300MM STANDARD DRAWER BOX INCLUDING RUNNERS	£83.24
DR/STAN350	350MM STANDARD DRAWER BOX INCLUDING RUNNERS	£83.24
DR/STAN400	400MM STANDARD DRAWER BOX INCLUDING RUNNERS	£83.24
DR/STAN450	450MM STANDARD DRAWER BOX INCLUDING RUNNERS	£83.24
DR/STAN500	500MM STANDARD DRAWER BOX INCLUDING RUNNERS	£91.24
DR/STAN550	550MM STANDARD DRAWER BOX INCLUDING RUNNERS	£91.24
DR/STAN600	600MM STANDARD DRAWER BOX INCLUDING RUNNERS	£91.24
DR/STAN800	800MM STANDARD DRAWER BOX INCLUDING RUNNERS	£99.24
DR/STAN900	900MM STANDARD DRAWER BOX INCLUDING RUNNERS	£99.24
DR/STAN100	1000MM STANDARD DRAWER BOX INCLUDING RUNNERS	£99.24
DR/PAN300	300MM PAN DRAWER BOX INCLUDING GLASS SIDES AND RUNNERS	£120.80
DR/PAN350	350MM PAN DRAWER BOX INCLUDING GLASS SIDES AND RUNNERS	£120.80
DR/PAN400	400MM PAN DRAWER BOX INCLUDING GLASS SIDES AND RUNNERS	£120.80
DR/PAN450	450MM PAN DRAWER BOX INCLUDING GLASS SIDES AND RUNNERS	£120.80
DR/PAN500	500MM PAN DRAWER BOX INCLUDING GLASS SIDES AND RUNNERS	£128.80
DR/PAN550	550MM PAN DRAWER BOX INCLUDING GLASS SIDES AND RUNNERS	£128.80
DR/PAN600	600MM PAN DRAWER BOX INCLUDING GLASS SIDES AND RUNNERS	£128.80
DR/PAN800	800MM PAN DRAWER BOX INCLUDING GLASS SIDES AND RUNNERS	£136.80
DR/PAN900	900MM PAN DRAWER BOX INCLUDING GLASS SIDES AND RUNNERS	£136.80
DR/PAN100	1000MM PAN DRAWER BOX INCLUDING GLASS SIDES AND RUNNERS	£136.80
CP063	300MM STANDARD INTERNAL DRAWER FRONT	£13.06
CP064	400MM STANDARD INTERNAL DRAWER FRONT	£13.10
CP065	500MM STANDARD INTERNAL DRAWER FRONT	£15.24
CP066	600MM STANDARD INTERNAL DRAWER FRONT	£16.34
CP067	800MM STANDARD INTERNAL DRAWER FRONT	£22.87
CP068	900MM STANDARD INTERNAL DRAWER FRONT	£23.95
CP069	1000MM STANDARD INTERNAL DRAWER FRONT	£25.05
CP070	300MM PAN INTERNAL DRAWER FRONT	£17.34
CP071	400MM PAN INTERNAL DRAWER FRONT	£18.34
CP072	500MM PAN INTERNAL DRAWER FRONT	£20.91
CP073	600MM PAN INTERNAL DRAWER FRONT	£21.99
CP074	800MM PAN INTERNAL DRAWER FRONT	£26.42
CP075	900MM PAN INTERNAL DRAWER FRONT	£27.42
CP076	1000MM PAN INTERNAL DRAWER FRONT	£28.44

HETTICH DRAWER BOX INSERTS

PLASTIC CUTLERY TRAYS		
CT300	300MM CUTLERY TRAY	£6.53
CT400	400MM CUTLERY TRAY	£7.32
CT450	450MM CUTLERY TRAY	£7.71
CT500	500MM CUTLERY TRAY	£8.10
CT600	600MM CUTLERY TRAY	£8.87
CT800	800MM CUTLERY TRAY	£12.08
CT900	900MM CUTLERY TRAY	£15.59
CT100	1000MM CUTLERY TRAY	£15.97



PAN DRAWER DIVIDER SETS		
OSTB810/600	UPTO 600mm WIDE 3 X DIVIDERS	£18.27
OSTB810/900	UPTO 900mm WIDE 5 X DIVIDERS	£27.40
OSTB810/120	UPTO 1200mm WIDE 6 X DIVIDERS	£32.88

Central divider will need to be cut to length to fit across the width of the drawer. Please select size above if required size is not listed.

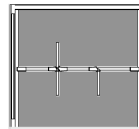

Upto 600mm
3 Dividers

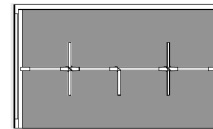

Upto 800mm
5 Dividers

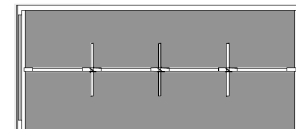

Upto 1200mm
6 Dividers



OAK MODULE TRAYS & INSERTS		
450 TO 500	(A) ONLY	£73.00
550 TO 600	(A) + (C)	£104.98
800 TO 1000	(A) + (B) + (C)	£165.12

Each module is supplied with an oak veneer bottom filler panel, this is used to make an additional tray space between modules if required. These panels may need to be cut down on site by your installer.

OTR/230/CT	(A) OAK CUTLERY MODULE	£73.00
OTR/230/EXT	(B) OAK UTENSIL MODULE	£60.14
OTR/230/KNIFE	(C) OAK KNIFE HOLDER MODULE	£31.98



(A) Oak Cutlery Module
450mm - 600mm Drawer.



(B) Oak Utensil Module
800mm - 1000mm Drawer



(C) Knife Holder
500mm - 1000mm Drawers



Peg base board 600, 800, 900 & 1000mm Wide
Dividers and pegs are sold separately.



(A) L Divider



(B) X Divider



(C) Square Peg

OAK PEG BASE BOARDS		
OST230/600	600MM OAK PEG BOARD BASE ONLY	£69.63
OST230/800	800MM OAK PEG BOARD BASE ONLY	£78.15
OST230/900	900MM OAK PEG BOARD BASE ONLY	£85.41
OST230/1000	1000MM OAK PEG BOARD BASE ONLY	£90.67

Once you have chosen the correct width peg base for your drawer width add any combination of pegs or dividers below.

L-DIV	(A) PAIR OF OAK L DIVIDERS 94 x 94mm	£73.00
X-DIV	(B) OAK X DIVIDER 179 x 179mm	£60.14
S-PEG	(C) SET OF 4 OAK SQUARE PEGS 20 x 20mm	£31.98

